



Hyperchill **Plus-E**

IT Manuale d'uso
EN User Manual
ES Manual de uso
FR Manuel d'utilisation
DE Benutzer Handbuch
PT Manual do utilizador
SV Bruksanvisning
FI Käsikirja
NO Brukermanual
NL Gebruikershandleiding
DA Brugermanual
PL Instrukcja obsługi
CS Návod na obsluhu
HU Használató utasítás

ICEP 008E

ICEP 011E

ICEP 015E

ICEP 022E

ICEP 027E

(50Hz) **CE**

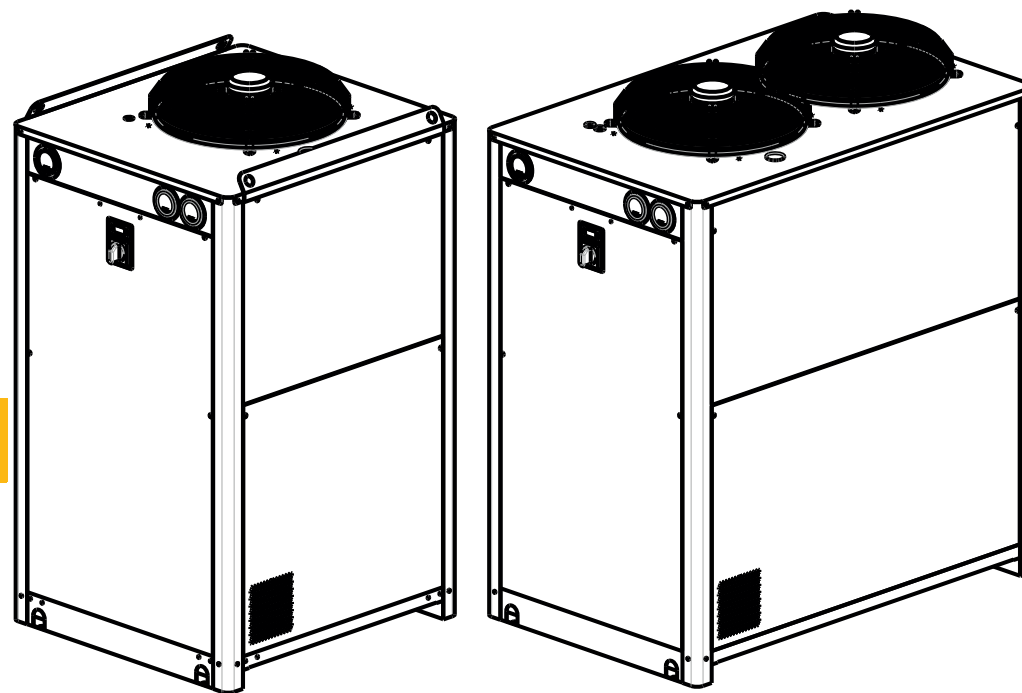

ENERGOEKONOM
spol. s r.o.

DATE: 03.12.2025 - Rev. 13
CODE: 398H271815



1 Sicurezza	2
1.1 Importanza del manuale.....	2
1.2 Segnali di avvertimento.....	2
1.3 Istruzioni di sicurezza.....	2
1.4 Rischi residui.....	2
2 Introduzione	3
2.1 Trasporto.....	3
2.2 Movimentazione.....	3
2.3 Ispezione.....	3
2.4 Immagazzinaggio.....	3
3 Installazione	3
3.1 Spazio operativo.....	3
3.2 Versione condensatore.....	3
3.3 Circuito idraulico.....	3
3.3.1 Controlli e collegamento.....	3
3.3.2 Acqua e glicole etilenico.....	4
3.3.3 Vaso d'espansione.....	4
3.4 Circuito elettrico.....	5
3.4.1 Controlli e collegamenti.....	5
3.4.2 Allarme generale.....	5
3.4.3 ON/OFF remoto.....	5
3.5 Versione con condensazione ad acqua (W).....	5
4 Controllo	6
4.1 Pannello di controllo.....	6
4.2 Significato simboli.....	6
4.3 Avviamento.....	6
4.3.1 Regolazioni al primo avviamento.....	6
4.3.2 Avviamento con acqua ad alta temperatura.....	6
4.4 Fermata.....	7
4.5 Definizione parametri.....	7
4.5.1 Parametri configurazione macchina (CF9).....	7
4.5.2 Termostatazione (TIP).....	7
4.5.3 Parametri manutenzione (MNT).....	7
4.5.4 Parametri sonda (BE 1, BE 2).....	7
4.5.5 Storico allarmi (RLH).....	7
4.6 Modifica parametri (User).....	8
4.6.1 Parametro configurazione "CF9".....	8
4.6.2 Parametro Termostatazione "TIP".....	13
4.6.3 Parametro sonda "BE 1".....	14
4.7 Visualizzazione sonde/ventilatore/compressore.....	14
4.8 Regolazione dell'orologio.....	15
4.9 Gestione allarmi.....	16
4.10 Storico allarmi.....	17
5 Manutenzione	17
5.1 Avvertenze generali.....	17
5.2 Refrigerante.....	17
5.3 Programma di manutenzione.....	18
5.4 Smantellamento.....	18

7 Appendice

7.1 Legenda
7.2 Diagramma di installazione
7.3 Movimentazione, spazio operativo
7.4 Dati tecnici
7.5 Dimensioni
7.6 Parti di ricambio
7.7 Disegni esplosi
7.8 Circuito frigorifero
7.9 Schema elettrico

1 Sicurezza

1.1 Importanza del manuale

- Conservarlo per tutta la vita della macchina.
- Leggerlo prima di qualsiasi operazione.
- E' suscettibile di modifiche: per una informazione aggiornata consultare la versione a bordo macchina.

1.2 Segnali di avvertimento



Istruzione per evitare pericoli a persone.



Istruzione da eseguire per evitare danni all'apparecchio.





E' richiesta la presenza di tecnico esperto e autorizzato.



Sono presenti simboli il cui significato è nel paragrafo 7.1

1.3 Istruzioni di sicurezza

 Ogni unità è munita di sezionatore elettrico per intervenire in condizioni di sicurezza. Usare sempre tale dispositivo per eliminare i pericoli durante la manutenzione.

 Il manuale è rivolto all'utente finale solo per operazioni eseguibili a pannelli chiusi: operazioni come installazione/primo avviamento/manutenzione o che prevedono l'apertura con attrezzi, devono essere eseguite da personale esperto e qualificato.

 Da installare solo in luoghi non accessibili al pubblico, in un luogo protetto con accesso limitato o a un'altezza non inferiore a 2,5 m, oppure in aree protette sui tetti, a meno che non siano stati supervisionati o abbiano ricevuto istruzioni riguardanti l'uso dell'apparecchio da una persona responsabile della loro sicurezza.



 La distanza di installazione dalla parete e lo spazio operativo libero sono indicati al par.7.3.

 **Attenzione:** rispettare la temperatura e la pressione Min./Max indicate al par. 7.4, e il campo di temperatura complessiva di funzionamento indicato al par. 7.2.

 **Tutte le unità possono essere installate all'esterno.**

 **Tutte le connessioni elettriche devono essere conformi alle prescrizioni locali del luogo di installazione.**

 Non superare i limiti di progetto riportati nella targa dati.

  È compito dell'utilizzatore evitare carichi diversi dalla pressione statica interna. Qualora sussista il rischio di azioni sismiche l'unità va adeguatamente protetta. Impiegare l'unità esclusivamente per uso professionale e per lo scopo per cui è stata progettata.

 E' compito dell'utilizzatore analizzare tutti gli aspetti dell'applicazione in cui il prodotto è installato, seguire tutti gli standards industriali di sicurezza applicabili e tutte le prescrizioni inerenti il prodotto contenute nel manuale d'uso ed in qualsiasi documentazione prodotta e fornita con l'unità. La manomissione o sostituzione di qualsiasi componente da parte di personale non autorizzato e/o l'uso improprio dell'unità esonerano il costruttore da qualsiasi responsabilità e provocano l'invalidità della garanzia.

Si declina ogni responsabilità presente e futura per danni a persone, cose e alla stessa unità, derivanti da negligenza degli operatori, dal mancato rispetto di tutte le istruzioni riportate nel presente manuale, dalla mancata applicazione delle normative vigenti relative alla sicurezza dell'impianto. Il costruttore non si assume la responsabilità per eventuali danni dovuti ad alterazioni e/o modifiche dell'imballo.

E' responsabilità dell'utilizzatore assicurarsi che le specifiche fornite per la selezione dell'unità o di suoi componenti e/o opzioni siano esaustive ai fini di un uso corretto o ragionevolmente prevedibile dell'unità stessa o dei componenti.

 **ATTENZIONE:** Il costruttore si riserva il diritto di modificare le informazioni contenute nel presente manuale senza alcun preavviso. Ai fini di una completa ed aggiornata informazione si raccomanda all'utente di consultare il costruttore.

1.4 Rischi residui

L'installazione, l'avviamento, lo spegnimento, la manutenzione della macchina devono essere tassativamente eseguiti in accordo con quanto riportato nella documentazione tecnica del prodotto e comunque in modo che non venga generata alcuna situazione di rischio. I rischi che non è stato possibile eliminare in fase di progettazione sono riportati nella tabella seguente.

Parte considerata	Rischio residuo	Modalità	Precauzioni
batteria di scambio termico	piccole ferite da taglio	contatto	evitare il contatto, usare guanti protettivi
griglia ventilatore e ventilatore	lesioni	inserimento di oggetti appuntiti attraverso la griglia mentre il ventilatore sta funzionando	non infilare oggetti di alcun tipo dentro la griglia dei ventilatori e non appoggiare oggetti sopra le griglie
interno unità: compressore e tubo di mandata	ustioni	contatto	evitare il contatto, usare guanti protettivi
interno unità: parti metalliche e cavi elettrici	intossicazioni, folgorazione, ustioni gravi	difetto di isolamento cavi alimentazione a monte del quadro elettrico dell'unità. Parti metalliche in tensione	protezione elettrica adeguata della linea alimentazione. Massima cura nel fare il collegamento a terra delle parti metalliche

Parte considerata	Rischio residuo	Modalità	Precauzioni
esterno unità: zona circostante unità	intossicazioni, ustioni gravi	incendio a causa corto circuito o surriscaldamento della linea alimentazione a monte del quadro elettrico dell'unità	sezione dei cavi e sistema di protezione della linea alimentazione elettrica conformi alle norme vigenti

2 Introduzione

I motori di compressore, pompa e ventilatore, sono dotati di una protezione termica che li protegge da eventuali surriscaldamenti.

2.1 Trasporto

L'unità imballata deve rimanere:

- in posizione verticale;
- protetta da agenti atmosferici;
- protetta da urti.

2.2 Movimentazione

Usare carrello elevatore a forza adeguato al peso da sollevare, evitando urti di qualsiasi tipo.

2.3 Ispezione

- In fabbrica tutte le unità sono assemblate, cablate, caricate con refrigerante ed olio, collaudate alle condizioni di lavoro standard;
- Ricevuta la macchina controllarne lo stato: contestare subito alla compagnia di trasporto eventuali danni;
- Disimballare l'unità il più vicino possibile al luogo dell'installazione.

2.4 Immagazzinaggio

- Mantenere l'unità imballata in luogo pulito e protetto da umidità e intemperie;
- Non sovrapporre le unità;
- Seguire le istruzioni riportate sull'imballo.

3 Installazione

 Per una installazione ottimale rispettare le indicazioni riportate nei paragrafi. 7.

 La macchina deve essere installata in ambienti adeguatamente protetti contro rischi di incendio (riferimento norma EN378-3).

 Si raccomanda di installare un adeguato pre-filtro vicino all'ingresso acqua del chiller (grado di filtrazione : min.05mm; max1.0mm).

 **Liquidi da raffreddare**

I liquidi da raffreddare devono essere compatibili con i materiali utilizzati.

Esempi di liquidi usati sono **acqua o miscela di acqua e glicole etilenico o propilenico**.

I liquidi da raffreddare non devono essere infiammabili.

Se i liquidi da raffreddare contengono sostanze pericolose (come ad esempio il glicole etilenico/propilenico) l'eventuale liquido fuoriuscito da una zona di perdita deve essere raccolto perchè dannoso per l'ambiente. In caso di svuotamento del circuito idraulico, attenersi alle normative vigenti e non disperdere il contenuto nell'ambiente.

3.1 Spazio operativo

 **Lasciare uno spazio di 1,5 metri attorno all'unità.**

Lasciare almeno 2 metri di spazio sopra il refrigeratore nei modelli ad espulsione verticale dell'aria di condensazione.

3.2 Versione condensatore

Versione ad aria (A)

Non creare situazioni di ricircolo dell'aria di raffreddamento. Non ostruire le griglie di ventilazione. Per le versioni con ventilatori assiali standard senza prevalenza esterna è vietata la canalizzazione dell'aria esausta.

Versione condensato ad acqua (W)

Se l'acqua al condensatore è in circuito aperto, installare filtro a rete su ingresso acqua di condensazione.

Per particolari acque di raffreddamento (deionizzata, demineralizzata, distillata) i materiali standard previsti per il condensatore potrebbero non essere adatti. In questi casi si prega di contattare il costruttore.

3.3 Circuito idraulico

3.3.1 Controlli e collegamento

 Prima di collegare il refrigeratore e riempire il circuito, assicurarsi che le tubazioni siano pulite. In caso contrario effettuare un lavaggio accurato.

  **Se il circuito idraulico è di tipo chiuso, in pressione, viene installata una valvola di sicurezza tarata a: 6 bar.**

 Si consiglia di installare sempre dei filtri a rete sulle tubazioni di ingresso e uscita acqua.

 Nel caso in cui il circuito idraulico sia intercettato da valvole automatiche, proteggere la pompa

con sistemi anti colpo d'ariete.

 Nel caso il circuito venga svuotato per fermate prolungate si consiglia di aggiungere del fluido lubrificante sulla girante della pompa per evitarne il blocco al successivo avviamento. In caso di blocco girante procedere con sblocco manuale.

Rimuovere il coperchio posteriore della pompa e girare delicatamente la ventola in plastica. Se l'albero risultasse ancora bloccato, rimuovere la ventola e agire direttamente sull'albero. Una volta sbloccata la girante, riposizionare ventola e coperchio.

Controlli preliminari

1. Controllare che le eventuali valvole di intercettazione del circuito idraulico siano aperte.
2. Se il circuito idraulico è di tipo chiuso, controllare che sia stato installato un vaso d'espansione di capacità adeguata. Vedere paragrafo

Collegamento

1. Collegare il refrigeratore alle tubazioni di ingresso e uscita, utilizzando gli appositi attacchi posizionati nella parte posteriore dell'unità.
Si consiglia l'utilizzo di giunti flessibili per togliere rigidità al sistema.
2. Riempire il circuito idraulico utilizzando l'apposito attacco di carica posizionato nella parte posteriore del refrigeratore
3. Il serbatoio è dotato di un'apposita valvola di sfogo che dovrà essere azionata manualmente al momento del riempimento. A tal proposito, se il circuito idraulico presenta dei punti ad altezza maggiore, installare una valvola di sfogo in tali punti.
4. Si consiglia di dotare le tubazioni di ingresso ed uscita di valvole, in modo da poter escludere la macchina dal circuito in caso di manutenzione e di regolazione per la pompa.
5. Se il chiller lavora con vasca aperta, la pompa deve essere installata in aspirazione alla vasca e in mandata al chiller.

 **Attenzione: (solo dai modelli 022-120) la macchina è dotata di un dispositivo di protezione per il serbatoio.**

Qualora si commettesse l'operazione errata di chiudere inavvertitamente l'ingresso acqua, quando la pompa è in funzione ed è aperta l'uscita acqua, entrerà aria nel serbatoio con probabile intervento del sensore di livello. Sarà necessario provvedere subito ad una corretta operazione di sfogo.

Controlli successivi

1. Controllare che il serbatoio ed il circuito siano completamente riempiti d'acqua e correttamente sfogati dall'aria.
2. Il circuito idraulico dev'essere sempre riempito. A tal fine si può provvedere ad un controllo e rabbocco periodico, oppure si può dotare l'impianto di un kit di riempimento automatico.

Caratteristiche dell'acqua

Se non previsto in fornitura, installare filtro a rete su ingresso acqua

 Caratteristiche acqua :

Temperatura	≥50°F (10°C)	CL ⁻	<50 ppm
ΔT IN/OUT	5-15°C	CaCO ₃	70-150 ppm
Max % glicole	40	O ₂	<0.1 ppm
Pressione	43.5-145 PSig (3-10 barg)	Fe	<0.2 ppm
PH	7.5-9	NO ₃	<2 ppm
Conduttività elettrica	10-500 μS/cm	HCO ₃ ⁻	70-300 ppm

Indice di saturazione di Langelier	0-1	H ₂ S	<0.05 ppm
SO ₄ ²⁻	<50 ppm	CO ₂	<5 ppm
NH ₃	<1 ppm	Al	<0.2 ppm

Per particolari acque di raffreddamento (deionizzata, demineralizzata, distillata) i materiali standard previsti per l'unità potrebbero non essere adatti. In questi casi si prega di contattare il costruttore.

3.3.2 Acqua e glicole etilenico

Se installato all'aperto, o comunque in ambiente chiuso non riscaldato, c'è la possibilità che, nei periodi di fermata dell'impianto in corrispondenza ai mesi più freddi dell'anno, l'acqua all'interno del circuito ghiacci.

Per ridurre questo pericolo si può:

- Dotare il refrigeratore di adeguate protezioni antigelo, fornite dal costruttore come opzionali;
- Scaricare l'impianto tramite l'apposita valvola di scarico, in caso di fermate prolungate;
- Aggiungere un'adeguata quantità di antigelo all'acqua di circolazione (vedi tabella).

Temperatura acqua in uscita [°C]	Glicole etilenico (% vol.)	Temperatura ambiente
4	5	-2
2	10	-5
0	15	-7
-2	20	-10
-4	25	-12
-6	30	-15
-10	40	-20

3.3.3 Vaso d'espansione

Per evitare che gli aumenti o diminuzioni di volume del fluido conseguenti ad una variazione sensibile della sua temperatura possano danneggiare la macchina o il circuito, è consigliabile installare un vaso d'espansione di capacità adeguata.

Il vaso d'espansione va installato in aspirazione alla pompa sull'attacco posteriore del serbatoio.

Per un calcolo del volume del vaso d'espansione da applicare ad un circuito chiuso si può utilizzare la formula seguente:

$$V=2 \times V_{tot} \times (P_{t \min} - P_{t \max})$$

dove

V_{tot}= vol. totale del circuito (in litri)

P_{t min}/max = peso specifico alla minima/massima temperatura raggiungibile dall'acqua [kg/dm³].

I valori di peso specifico in funzione della temperatura e della percentuale di glicole, sono riportati in tabella.

% glicole	Temperatura [°C]						
	-10	0	10	20	30	40	50
0%	1.0024	1.0008	0.9988	0.9964	0.9936	0.9905	0.9869
10%	1.0177	1.0155	1.0130	1.0101	1.0067	1.0030	0.9989
20%	1.0330	1.0303	1.0272	1.0237	1.0199	1.0156	1.0110
30%	1.0483	1.0450	1.0414	1.0374	1.0330	1.0282	1.0230
40%	1.0636	1.0594	1.0525	1.0511	1.0461	1.0408	1.0350

 **Attenzione: In fase di riempimento fare riferimento ai dati di carica anche del vaso di espansione.**

Se la temperatura dell'aria ambiente attorno al refrigeratore è inferiore a -10°C, è necessario spostare il vaso di espansione in un ambiente protetto vicino sul lato di ritorno dell'acqua del refrigeratore. La valvola di sicurezza e la valvola di sfato devono rimanere sul refrigeratore.

3.4 Circuito elettrico

3.4.1 Controlli e collegamenti



Prima di effettuare qualsiasi operazione su parti elettriche assicurarsi che non vi sia tensione. Tutte le connessioni elettriche devono essere conformi alle prescrizioni locali del luogo di installazione.

Controlli iniziali

1. La tensione e la frequenza di rete devono corrispondere ai valori stampigliati sulla targhetta dati del refrigeratore. La tensione di alimentazione non deve, neppure per brevi periodi, essere fuori dalla tolleranza riportata sullo schema elettrico che, salvo diverse indicazioni, è pari +/- 10% per la tensione; +/- 1% sulla frequenza.
2. 2) La tensione deve essere simmetrica (valori efficaci delle tensioni ed angoli di fase fra fasi consecutive uguali fra loro). Il massimo squilibrio ammesso fra le tensioni è pari al 2%.

Collegamento

1. L'alimentazione elettrica dei refrigeratori viene effettuata con cavo a 4 fili , 3 poli +terra, senza neutro. Per la sezione vedere paragrafo 7.
2. Passare il cavo attraverso il pressacavo posto sul pannello posteriore della macchina e collegare fase e neutro ai morsetti del sezionatore generale (QS), la terra va collegata all'apposito morsetto di terra (PE).
3. Assicurare all'origine del cavo di alimentazione una protezione contro i contatti diretti pari ad almeno IP2Xo IPXXB.
4. Installare , sulla linea di alimentazione elettrica del refrigeratore, un interruttore automatico con differenziale (RCCB - IDn = 0.3A), della portata massima indicata nello schema elettrico di riferimento, con potere di interruzione adeguato alla corrente di corto circuito esistente nella zona d'installazione della macchina.
La corrente nominale "In" di tale magnetotermico deve essere uguale a FLA e la curva di intervento di tipo D.
5. Valore massimo dell'impedenza di rete = 0.274 ohm.

Controlli successivi

Assicurarsi che la macchina e le apparecchiature ausiliarie siano state messe a terra e protette contro cortocircuiti e/o sovraccarichi.



Una volta che l'unità è stata collegata e l'interruttore generale a monte è stato chiuso (dando così tensione alla macchina), il voltaggio nel circuito elettrico raggiunge valori pericolosi. Massima precauzione!



È responsabilità dell'installatore effettuare le prove minime obbligatorie per garantire una corretta installazione elettrica, in conformità con la legislazione locale e in coordinamento con il sistema di messa a terra pertinente, inclusi i requisiti specifici per i sistemi con neutro isolato (IT).

3.4.2 Allarme generale

Tutti i refrigeratori sono provvisti della segnalazione allarme macchina (vedere schema elettrico), costituita da un contatto libero in scambio riportato in morsettiera: ciò permette di allacciare un allarme centralizzato esterno, acustico, visivo o inserito in logiche es. PLC.

3.4.3 ON/OFF remoto

Tutti i refrigeratori hanno la possibilità di avere un comando di avviamento e fermata remoto (par.xx):

- Per abilitare il remoto rif. n.16387

- Per variabile di riferimento ON/OFF rif.n.8996

Nota: non abilitare "Sup" e "Re" insieme.

Per il collegamento del contatto ON-OFF remoto vedere lo schema elettrico (par. xx).

3.5 Versione con condensazione ad acqua (W)

I chiller in versione con condensazione ad acqua, necessitano di un circuito idraulico che porti l'acqua fredda al condensatore.

Il chiller in versione ad acqua è dotato di una valvola pressostatica, in entrata al condensatore, la cui funzione è quella di regolare la portata d'acqua in modo da ottenere sempre una condensazione ottimale.

Controlli preliminari

Se l'alimentazione di acqua al condensatore viene realizzata tramite circuito chiuso, effettuare tutti i controlli preliminari elencati per il circuito idraulico principale (paragrafo 3.3.1).

Collegamento

1. Si consiglia di dotare il circuito acqua di condensazione di valvole di intercettazione, in modo da poter escludere la macchina in caso di manutenzione.
2. Collegare le tubazioni di mandata/ritorno acqua agli appositi attacchi posti sul retro dell'unità.
3. 3) Se l'acqua di condensazione è " a perdere", si consiglia di dotare il circuito di un filtro in ingresso al condensatore, in modo da limitare il rischio di sporcamento delle superfici.
4. Se il circuito è di tipo chiuso, verificare che sia ben riempito d'acqua e correttamente sfatato dall'aria.

4 Controllo

4.1 Pannello di controllo



Pulsante SU: per aumentare il valore dei parametri modificabili.



Pulsante GIU': per diminuire il valore dei parametri modificabili.



Pulsante ESC: per uscire senza salvare; torna al livello precedente;

SE PREMUTO PER 5s. RESET ALLARMI.



Pulsante SET: per uscire e salvare/ confermare il valore; accedere al Menu Stati;

SE PREMUTO PER 5s. AVVIO CHILLER.

4.2 Significato simboli

Simbolo	Stato del simbolo	funzione	Simbolo	Stato del simbolo	funzione	
	Acceso	Compressore ON		Acceso	Valore di Temperatura	
	Lampeggiante	Compressore stand_by			Acceso	Valore di Pressione
	Spento	Compressore Off				Acceso
	Acceso	Allarme presente		Spento		Resistenza antigelo Off
	Lampeggiante	Avviso o Allarme resetabile				Acceso
	Spento	Nessun allarme			Spento	Resistenza carter Off Compressore 1
	Acceso	Pompa 1 ON			Acceso	Resistenza carter ON Compressore 2 (non presente)
Spento	Pompa 1 Off		Spento		Resistenza carter Off Compressore 2 (non presente)	
Acceso	Pompa 2 ON (non presente)			Acceso	Resistenza carter ON Compressore 2 (non presente)	
Spento	Pompa 2 Off (non presente)	Spento		Resistenza carter Off Compressore 2 (non presente)		

4.3 Avviamento

1. Dare tensione alla macchina mettendo in on il sezionatore generale QS.
2. Tenere premuto il pulsante "set" fino all'avvio della macchina.
3. Impostare sul controllore la temperatura desiderata (par. 4.5.1)

Monitore di fase

Se al l' avviamento compare a display l'allarme "E-23", l'utente deve verificare di avere eseguito correttamente il cablaggio deimorsetti di ingresso all'interruttore sezionatore.

4.3.1 Regolazioni al primo avviamento

1. Regolazione temperatura dell'acqua. Vedere paragrafo 4.5.
2. Regolazione della pompa

Verificare il corretto funzionamento della pompa utilizzando il manometro (leggere P1 e P0) e i valori limite di pressione (Pmax e Pmin) riportati sulla targa dati della pompa.

P1 = pressione con pompa ON

P0 = pressione con pompa OFF

$P_{min} < (P1 - P0) < P_{max}$

- Esempio n°1.

Condizioni:

circuito chiuso a pressione P0 di 2 bar

dati targa pompa: Pmin 1bar/ Pmax 3bar

regolare l'uscita valvola per una pressione di $3bar < P1 < 5Bar$

- Esempio n°2.

Condizioni:

circuito aperto a pressione P0 di 0 bar

dati targa pompa: Pmin 1bar/ Pmax 3bar

regolare l'uscita valvola per una pressione di $1bar < P1 < 3Bar$

3. Verificare il corretto funzionamento della pompa anche in condizioni di regime.

Verificare inoltre che l'ampereaggio della pompa sia entro i limiti di targa.

4. Spegner il chiller e procedere con il rabbocco del circuito idraulico con la temperatura di "SET".

5. e) Controllare che la temperatura dell'acqua "trattata" non scenda sotto i 5°C e la temperatura ambiente in cui opera il circuito idraulico non scenda sotto 5°C. In caso contrario aggiungere all'acqua l'opportuna quantità di glicole, come spiegato nel paragrafo 3.3.3.



ATTENZIONE! prima dell'accensione pompa del chiller, chiudere la valvola di uscita acqua (installazione a cura del cliente).

Mantenere sempre aperta la valvola in ingresso (installazione a cura del cliente).

Accendere la pompa, aprire lentamente la valvola di uscita acqua chiller ed eseguire la regolazione della portata come descritto al punto 4.3.1.

4.3.2 Avviamento con acqua ad alta temperatura

Nel caso in cui la temperatura dell'acqua nel circuito sia elevata (ad esempio, 30-35 °C), chiudere progressivamente (ma non completamente, circa due terzi!) la valvola di intercettazione (a cura del cliente) in uscita dal refrigeratore per ridurre la portata d'acqua attraverso l'unità. Aprire gradualmente la valvola non appena la temperatura dell'acqua scende al valore di esercizio.

Importante: in questa condizione potrebbero verificarsi più allarmi di alta pressione che devono essere resettati manualmente.

Importante: questa regolazione consente anche di evitare colpi d'ariete lungo le tubazioni dovuti a sacche d'aria presenti nel circuito (le sacche d'aria devono essere eliminate tramite valvole di sfogo

aria nei punti più alti del circuito idraulico a cura del cliente).

4.4 Fermata

Quando non è più richiesto il funzionamento del refrigeratore mettere in off il refrigeratore come segue: premere il tasto "SET" (5 sec.).

Non mettere in off il sezionatore generale QS in modo da garantire l'alimentazione di eventuali resistenze antigelo presenti nel refrigeratore.

4.5 Definizione parametri

Generalità

Esistono due livelli di protezione per i parametri:

- a) Diretto User-(U): con accesso immediato, **Modificabili/visibili**;
- b) Sotto password Service-(S): con accesso con password; **Parametri da non modificare**.

4.5.1 Parametri configurazione macchina (CF9)

PARAMETRO	CODICE	TIPO	DEFAULT
Selezionare unità di misura	R1	U	OFF
Gestione relè allarme	CFJ1	U	0
Ripristino parametri di default	DEF	U	OFF
Abilitazione on / off remoto	R7	U	0
Versione Software	VER	U	1.69
Indirizzo unità	CF30	U	1
Baud rate	CF31	U	5
Protocollo modbus	CF32	U	1
Abilitazione on / off remoto supervisore	SUP	U	OFF
Abilitazione al set point dinamico	ErD	U	OFF

4.5.2 Termostatazione (CTP)

PARAMETRO	CODICE	TIPO	DEFAULT
Set point temperatura (standard)	SET	U	13.0
Set point temperatura (controllo di precisione)	SET	U	20.0
Differenziale (NON visibile con codice "CPt=0n")	dIF1	U	4.0

4.5.3 Parametri manutenzione (Mnt)

PARAMETRO	CODICE	TIPO	DEFAULT
Ore lavoro unità	UH	U	-
Ore lavoro unità (X1000)	UHL	U	-
Ore lavoro unità parziali	UPH	U	-
Ore lavoro unità parziali (X1000)	UPHL	U	-
Ore lavoro compressore 1	CH	U	-
Ore lavoro compressore 1 (x1000)	CHL	U	-

PARAMETRO	CODICE	TIPO	DEFAULT
Ore lavoro compressore 2 (solo dal 55-65)	CH	U	-
Ore lavoro compressore 2 (x1000) (solo dal 55-65)	CHL	U	-

4.5.4 Parametri sonda (bt 1, bt2)

Sonda (bt 1)

PARAMETRO	CODICE	TIPO	DEFAULT
Allarme alta temperatura (acqua)	HR1	U	60

Sonda (bt2)

PARAMETRO	CODICE	TIPO	DEFAULT
Allarme alta temperatura (acqua)	HR2	U	60

4.5.5 Storico allarmi (ALH 1)

PARAMETRO	CODICE	TIPO	DEFAULT
Numero allarme	HYS1	U	-
Codice allarme	HYS2	U	-
Giorno/mese accadimento allarme	HYS3	U	-
Ore/minuto accadimento allarme	HYS4	U	-
Lettura sonda bt1 al momento dell'allarme	HYS5	U	-
Lettura sonda bt2 al momento dell'allarme	HYS6	U	-
Lettura sensore pressione al momento dell'allarme	HYS7	U	-

4.6 Modifica parametri (User)

4.6.1 Parametro configurazione "CF9"

Unità di misura

Dare tensione alla macchina mettendo in "ON" il sezionatore generale QS, ed attendere la visualizzazione della scritta "OFF". Premere i tasti "esc" "set" simultaneamente per entrare nei parametri tipo "U".	
Appare il parametro "PAR". Premere il tasto "set" per entrare.	
Appare il parametro "CF9". Premere il tasto "set" per entrare.	
Appare il parametro "A1". Premere il tasto "set" per entrare.	
Il valore di default è "OFF" = °C Utilizzare i tasti "↓" e "↑" per scegliere l'unità di misura OFF = C°, Celsius ; ON = °F, Fahrenheit	
Premere il tasto "set" per confermare.	
Si torna automaticamente al menu "A1" Il parametro ora è stato memorizzato. Premere il tasto "esc" per uscire, tre volte.	







Gestione allarme

Dare tensione alla macchina mettendo in "ON" il sezionatore generale QS, ed attendere la visualizzazione della scritta "OFF". Premere i tasti "esc" "set" simultaneamente per entrare nei parametri tipo "U".	
Appare il parametro "PAR". Premere il tasto "set" per entrare.	
Appare il parametro "CF9". Premere il tasto "set" per entrare.	
Appare il parametro "A1". Utilizzare i tasti "↓" e "↑" per selezionare il parametro "CFJ1".	
Premere il tasto "set" per entrare	
Il valore di default è "0" Utilizzare i tasti "↓" e "↑" per scegliere la gestione del Relè (par.4.5.1-Tab.1)	
Premere il tasto "set" per confermare.	
Si ritorna al menu "CFJ1" Il parametro ora è stato memorizzato. Premere il tasto "esc" per uscire, tre volte.	





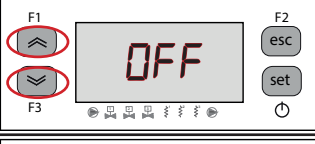

Tab.1 Gestione relè allarme (CFJ1.)

0	Relè normalmente diseccitato, viene eccitato in presenza di un allarme.
1	Relè normalmente eccitato (anche con controllo in OFF), viene diseccitato in presenza di un allarme.
2	Relè normalmente eccitato (solo con in ON), viene diseccitato in presenza di un allarme o con controllo in OFF.

Parametri di Default

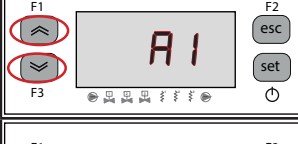
Dare tensione alla macchina mettendo in "ON" il sezionatore generale QS, ed attendere la visualizzazione della scritta "OFF". Premere i tasti "esc" e "set" simultaneamente per entrare nei parametri tipo "U".	
Appare il parametro "PAR". Premere il tasto "set" per entrare.	
Appare il parametro "CF9". Premere il tasto "set" per entrare.	
Appare il parametro "A1". Utilizzare i tasti "down" e "up" per selezionare il parametro "dEF".	
Premere il tasto "set" per entrare	
Il valore di default è "OFF". Utilizzare i tasti "down" e "up" per cambiare da "OFF" a "On".	
Premere il tasto "set" per confermare.	
Si ritorna al menu "dEF". I parametri sono stati ripristinati automaticamente. Premere il tasto "esc" per uscire, tre volte.	

Remoto ON/OFF

Dare tensione alla macchina mettendo in "ON" il sezionatore generale QS, ed attendere la visualizzazione della scritta "OFF". Premere i tasti "esc" e "set" simultaneamente per entrare nei parametri tipo "U".	
Appare il parametro "PAR". Premere il tasto "set" per entrare.	
Appare il parametro "CF9". Premere il tasto "set" per entrare.	
Appare il parametro "A1". Utilizzare i tasti "down" e "up" per selezionare il parametro "A7".	
Premere il tasto "set" per entrare	
Il valore di default è "0". Utilizzando i tasti "down" e "up" scegliere il funzionamento: (par. 4.5.1- Tab.2)	
Premere il tasto "set" per conferma.	
Si ritorna al menu "A7". Il parametro ora è stato memorizzato. Premere il tasto "esc" per uscire, tre volte.	

Tab.2 Modalità On/Off remoto (A1)

0	On/Off remoto disabilitato
1	On/Off remoto abilitato assieme al On/Off da locale. In caso di caduta di tensione, o di spegnimento tramite interruttore generale, al ritorno della corrente il chiller deve essere riavviato localmente.
2	Solo On/Off remoto, On/Off da locale disabilitato









Versione software

Dare tensione alla macchina mettendo in "ON" il sezionatore generale QS, ed attendere la visualizzazione della scritta "OFF". Premere i tasti "esc" "set" simultaneamente per entrare nei parametri tipo "U".	
Appare il parametro "PAR". Premere il tasto "set" per entrare.	
Appare il parametro "CF9". Premere il tasto "set" per entrare.	
Appare il parametro "A I". Utilizzare i tasti "down arrow" e "up arrow" per selezionare il parametro "UER".	
Premere il tasto "set" per entrare	
Viene visualizzata la versione di software	
Premere il tasto "esc" per uscire, tre volte.	







Abilitazione supervisore

Dare tensione alla macchina mettendo in "ON" il sezionatore generale QS, ed attendere la visualizzazione della scritta "OFF". Premere i tasti "esc" "set" simultaneamente per entrare nei parametri tipo "U".	
Appare il parametro "PAR". Premere il tasto "set" per entrare.	
Appare il parametro "CF9". Premere il tasto "set" per entrare.	
Appare il parametro "A I". Utilizzare i tasti "down arrow" e "up arrow" per selezionare il parametro "SUP".	
Premere il tasto "set" per entrare	
Il valore di default è "OFF" Utilizzare i tasti "down arrow" e "up arrow" per cambiare	
Premere il tasto "set" per conferma.	
Il parametro ora è stato memorizzato. Premere il tasto "esc" per uscire, per tre volte	

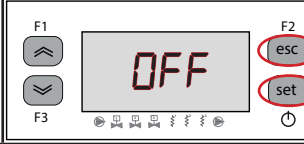
Modbus (indirizzo)

Dare tensione alla macchina mettendo in "ON" il sezionatore generale QS, ed attendere la visualizzazione della scritta "OFF". Premere i tasti "esc" e "set" simultaneamente per entrare nei parametri tipo "U".	
Appare il parametro "PAR". Premere il tasto "set" per entrare.	
Appare il parametro "CF9". Premere il tasto "set" per entrare.	
Appare il parametro "A1". Utilizzare i tasti "\Downarrow" e "\Uparrow" per selezionare il parametro "CF30".	
Premere il tasto "set" per entrare	
Il valore di default è "1". Utilizzare i tasti "\Downarrow" e "\Uparrow" per cambiare indirizzo	
Premere il tasto "set" per conferma.	
Il parametro ora è stato memorizzato. Premere il tasto "esc" per uscire, per tre volte	

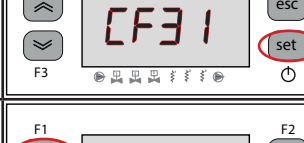
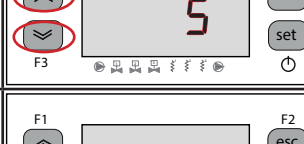
Modbus (baud rate)

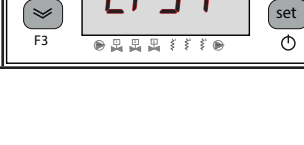
Dare tensione alla macchina mettendo in "ON" il sezionatore generale QS, ed attendere la visualizzazione della scritta "OFF". Premere i tasti "esc" e "set" simultaneamente per entrare nei parametri tipo "U".	
Appare il parametro "PAR". Premere il tasto "set" per entrare.	
Appare il parametro "Cf9". Premere il tasto "set" per entrare.	
Appare il parametro "A1". Utilizzare i tasti "\Downarrow" e "\Uparrow" per selezionare il parametro "CF31".	
Premere il tasto "set" per entrare.	
Il valore di default è "5". Utilizzare i tasti "\Downarrow" e "\Uparrow" per cambiare protocollo. (par. 4.5.1- Tab.3)	
Premere il tasto "set" per conferma.	
Il parametro ora è stato memorizzato. Premere il tasto "esc" per uscire, per tre volte	

Tab.3 Baud rate (opzionale)[CF31]

1	2400	3	9600	5	38400	7	115200
2	4800	4	19200	6	57600		

Modbus (protocollo)

Dare tensione alla macchina mettendo in "ON" il sezionatore generale QS, ed attendere la visualizzazione della scritta "OFF". Premere i tasti "esc" "set" simultaneamente per entrare nei parametri tipo "U".	
Appare il parametro "PAR". Premere il tasto "set" per entrare.	
Appare il parametro "CF9". Premere il tasto "set" per entrare.	
Appare il parametro "A I". Utilizzare i tasti "⏪" e "⏩" per selezionare il parametro "CF32".	
Premere il tasto "set" per entrare	
Il valore di default è "1". Utilizzare i tasti "⏪" e "⏩" per cambiare il baud rate. (par. 4.5.1- Tab.4)	
Premere il tasto "set" per conferma.	
Il parametro ora è stato memorizzato. Premere il tasto "esc" per uscire, per tre volte	

Tab.4 Protocollo modbus (opzionale)(CF32)

1	EVEN	2	NONE	3	ODD
---	------	---	------	---	-----

Nota: se si cambiano i parametri MODBUS, per validare i nuovi parametri bisogna spegnere e riaccendere il chiller.









Abilitazione ERD

Dare tensione alla macchina mettendo in "ON" il sezionatore generale QS, ed attendere la visualizzazione della scritta "OFF". Premere i tasti "esc" "set" simultaneamente per entrare nei parametri tipo "U".	
Appare il parametro "PAR". Premere il tasto "set" per entrare.	
Appare il parametro "CF9". Premere il tasto "set" per entrare.	
Appare il parametro "A I". Utilizzare i tasti "⏪" e "⏩" per selezionare il parametro "ErD".	
Premere il tasto "set" per entrare	
Il valore di default è "OFF". Utilizzare i tasti "⏪" e "⏩" per cambiare	
Premere il tasto "set" per conferma.	
Il parametro ora è stato memorizzato. Premere il tasto "esc" per uscire, per tre volte	

Con il parametro ERD attivato: la temperatura dell'acqua in uscita si regola in base alla temperatura ambiente. La funzione si attiva solo se il controllo di precisione della temperatura è disabilitato (CPT=OFF).

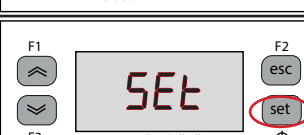



4.6.2 Parametro Termostatazione "CNP"

Regolazione del set temperatura

Dare tensione alla macchina mettendo in "ON" il sezionatore generale QS, ed attendere la visualizzazione della scritta "OFF". Premere i tasti "esc" e "set" simultaneamente per entrare nei parametri tipo "U".	
Appare il parametro "PAR". Premere il tasto "set" per entrare.	
Appare il parametro "CF9". Utilizzando i tasti "↓" e "↑" per selezionare il parametro "CNP".	
Premere il tasto "set" per conferma.	
Appare il parametro "SEt". Premere il tasto "set" per entrare.	
Il valore di default è "13.0". Utilizzare i tasti "↓" e "↑" per modificare il valore.	
Premere il tasto "set" per confermare.	
Il parametro ora è stato memorizzato. Premere per uscire "esc" per uscire, tre volte.	

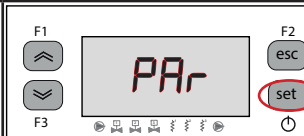
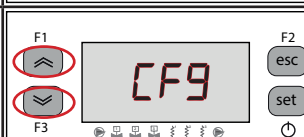

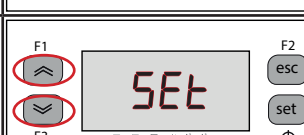

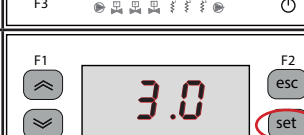
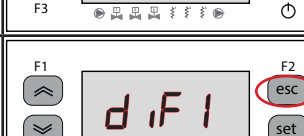



Importante: una regolazione della temperatura tra 1°C e 5°C deve essere effettuata da tecnici specializzati che devono utilizzare il manuale service specifico di questo prodotto.

Regolazione del differenziale temperatura

Dare tensione alla macchina mettendo in "ON" il sezionatore generale QS, ed attendere la visualizzazione della scritta "OFF". Premere i tasti "esc" e "set" simultaneamente per entrare nei parametri tipo "U".	
Appare il parametro "PAR". Premere il tasto "set" per entrare.	
Appare il parametro "CF9". Utilizzando i tasti "↓" e "↑" per selezionare il parametro "CNP".	
Premere il tasto "set" per conferma.	
Appare il parametro "SEt". Utilizzare i tasti "↓" e "↑" per selezionare il parametro "dIF1".	
Premere il tasto "set" per entrare.	
Il valore di default è "4.0". Utilizzare i tasti "↓" e "↑" per modificare il valore.	
Premere il tasto "set" per confermare.	
Il parametro ora è stato memorizzato. Premere per uscire "esc" per uscire, tre volte.	





4.6.3 Parametro sonda "bt 1"

Sonda "bt 1".

Dare tensione alla macchina mettendo in "ON" il sezionatore generale QS, ed attendere la visualizzazione della scritta "OFF". Premere i tasti "esc" e "set" simultaneamente per entrare nei parametri tipo "U".	
Appare il parametro "PAr". Premere il tasto "set" per entrare.	
Appare il parametro "CF9". Utilizzare i tasti "↓" e "↑" per selezionare il parametro "bt 1".	
Premere il tasto "set" per conferma.	
Appare il parametro "HA 1". Premere il tasto "set" per entrare.	
Il valore di default è "60.0". Utilizzare i tasti "↓" e "↑" per modificare il valore.	
Premere il tasto "set" per confermare.	
Il parametro ora è stato memorizzato. Premere per uscire "esc" per uscire, tre volte.	

Stessa sequenza per la sonda "bt2".

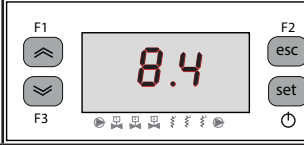
4.7 Visualizzazione sonde/ventilatore/compressore

Con l'unità in ON. Premere il tasto "↑" per visualizzare le sonde bt 1, bt2, bt3, bP 1.....	
Selezionare la sonda ed attendere qualche secondo. (es. BT2)	
Appare il valore della sonda BT2.	
Si consiglia di tornare sempre alla sonda BT1.	

Descrizione:

- bt 1 : sonda temperatura uscita acqua
- bt 2 : sonda temperatura evaporatore
- bt 3 : sonda temperatura ambiente
- bt 10 : sonda temperatura quadro elettrico (opzione)
- bP 1 : trasduttore circuito 1
- bP 2 : trasduttore circuito 2 (dal modello ICEP080);









F_ _ : funzionamento ventilatori

- F_ _ : ventilatori spenti.
- F- _ : ventilatore 1 ON, ventilatore 2 e 3 OFF; (2 = dal modello ICEP022) (3 = dal modello ICEP080)
- F-- _ : ventilatore 1 e 2 ON, ventilatore 3 OFF, (2 = dal modello ICEP022) (3 = dal modello ICEP080)
- F--- : ventilatori 1,2 e 3 ON (dal modello ICEP080)

ICE_ : funzionamento compressori

- ICE_ : compressori disabilitati
- ICE- : compressori OFF
- ICE- : compressore 1 ON, compressore 2 OFF
- ICE_ : compressori 1 e 2 ON (dal modello ICEP055)
- ICE- : con "!" lampeggiante compressore 1 pronto a partire, compressore 2 OFF

4.8 Regolazione dell'orologio

<p>Dare tensione alla macchina mettendo in "ON" il sezionatore generale QS, ed attendere la visualizzazione della scritta "OFF".</p> <p>Premere i tasti "⏪" e "⏩" simultaneamente per entrare nel menu "data/ora".</p>	
<p>Appare il parametro "FrEE".</p> <p>Premere il tasto "set" per entrare.</p>	
<p>Appare il parametro "A."..</p> <p>Utilizzare i tasti "⏪" e "⏩" per selezionare il parametro "CL".</p>	
<p>Premere il tasto "set" per conferma.</p>	
<p>Appare il paramero "HOUr".</p> <p>Tenere premuto per 5 secondi il tasto "set".</p> <p>Ora il parametro è lampeggiante.</p>	
<p>utilizzare i tasti "⏪" e "⏩" per scegliere data, ora o anno da cambiare.</p>	
<p>Premere il tasto "set" per entrare.</p>	
<p>utilizzare i tasti "⏪" e "⏩" per modificare il valore (es: anno)</p>	
<p>Premere il tasto "set" per confermare.</p>	

utilizzare i tasti "⏪" e "⏩" per cambiare un altro valore (es:Data)



Premere il tasto "esc" per uscire



Premere i tasti "⏪" e "⏩" simultaneamente per uscire



⚠ La memoria dell' orologio/data ha una durata massima di tre giorni, quindi se il controllore viene lasciato senza alimentazione per più di tre giorni vengono persi i dati impostati: ora/mese/anno .
Effettuare la regolazione dell'orologio al primo avviamento della macchina, ed ogni volta che si renda necessario.

4.9 Gestione allarmi

In presenza di un allarme, compare il codice allarme ed in alto a sinistra il simbolo .

 Continuo = allarme presente
lampeggiante = avviso presente



Premere il tasto "set" per entrare nei sottomenu.



Appare il parametro "ALH".

Premere il tasto "↵" per selezionare il parametro "AL".



Premere il tasto "set" per entrare.



Appare il parametro es: "Er08".

Premere il tasto "↵" per verificare se ci sono più allarmi presenti.



Riparare il guasto prima di eseguire il reset.

Una volta riparato il guasto, il simbolo di allarme comincia a lampeggiare.

Ora è possibile effettuare il reset.

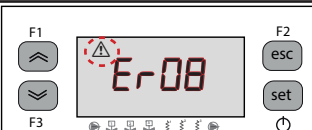





Premere il tasto "esc" fino a quando scompare l'allarme.

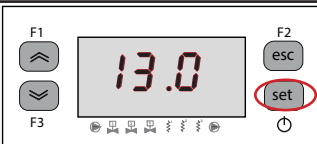

Lista allarmi/avvisi

CODICE	DESCRIZIONE	AZIONE	RESET
Er01	Sonda bt1 Aperta / Rotta	Allarme	M
Er02	Sonda bt2 Aperta / Rotta	Allarme	M
Er03	Sonda bt3 Aperta / Rotta	Allarme	A
Er05	Sonda bt10 Aperta / Rotta	Allarme	A
Er06	Sonda bP1 Aperta / Rotta	Allarme	M
Er08	Alta Pressione Circuito 1	Allarme	M
Er09	Bassa Pressione Circuito 1	Allarme	M
Er12	Alta Temperatura bt1	Allarme	M
Er13	Bassa Temperatura bt1	Allarme	A
Er14	Alta Temperatura bt2	Allarme	M
Er15	Bassa Temperatura bt2	Allarme	M
Er16	Alta Temperatura bt3	Allarme	A
Er17	Bassa Temperatura bt3	Allarme	A
Er18	Termica Compressore 1	Allarme	M
Er20	Termica Pompa 1	Allarme	M
Er22	Basso Livello acqua/ pressostato differenziale	Allarme	M
Er23	Monitore di Fase	Allarme	M
Er24	Espansione Rotta / disconnessa	Allarme	M
Er25	Ore Lavoro Compressore 1	Avviso	M
Er27	Ore Lavoro Macchina	Avviso	M
Er28	Memoria orologio	Avviso	A
Er29	Configurazione chiller	Avviso	A

4.10 Storico allarmi





Con l'unità in ON. Premere il tasto "set" per visualizzare lo storico allarmi.	
Premere il tasto "set" per entrare	
utilizzare i tasti "↓" e "↑" per vedere i parametri. (Par. 4.5.5)	
Premere il tasto "set" per visualizzare il valore.	

5 Manutenzione

• La macchina è progettata e costruita per garantire un funzionamento continuativo; la durata dei suoi componenti è però direttamente legata alla manutenzione eseguita.

-  In caso di richiesta di assistenza o ricambi, identificare la macchina (modello e numero di serie) leggendo la targhetta di identificazione esterna all'unità. (www.polewr.com)

5.1 Avvertenze generali

-  Prima di qualsiasi manutenzione verificare che il refrigeratore non sia più alimentato.
-  Utilizzare sempre ricambi originali del costruttore: pena l'esonero del costruttore da qualsiasi responsabilità sul malfunzionamento della macchina.
-  In caso di perdita di refrigerante contattare personale esperto ed autorizzato.
-  La valvola Schrader è da utilizzare solo in caso di anomalo funzionamento della macchina: in caso contrario i danni provocati da errata carica di refrigerante non verranno riconosciuti in garanzia.

5.2 Refrigerante













Operazione di carica: eventuali danni provocati da errata carica refrigerante eseguita da personale non autorizzato non verranno riconosciuti in garanzia. 

-  L'apparecchiatura contiene gas fluorurati a effetto serra.
Il fluido frigorifero R513A a temperatura e pressione normale è un gas incolore appartenente al SAFETY GROUP A1 - EN378 (fluido gruppo 2 secondo direttiva PED 2014/68/UE);
GWP (Global Warming Potential) = 629.

-  In caso di fuga di refrigerante aerare il locale.

5.3 Programma di manutenzione

Per garantire nel tempo la massima efficienza ed affidabilità del chiller eseguire:

Descrizione attività di manutenzione	Intervallo manutenzione (in condizioni di funzionamento standard)			
	Ogni giorno	Ogni 6 Mes	Ogni 12 Mes	Ogni 36 Mes
Attività Controllo  Service 				
Controllare che la spia POWER ON sia accesa.				
Controllare gli indicatori del pannello di controllo.				
Pulire le alette del condensatore.				
Controllare l'assorbimento elettrico				
Controllare le perdite di refrigerante				
Controllare e pulire la valvola di sicurezza acqua (se presente)*				
Controllare l'impianto elettrico a bordo macchina ed il quadro elettrico**				
Controllare sonde temperature Sostituire se necessario				 
Kit di manutenzione				

 Sono disponibili (vedere paragrafo 7.):

- Service kit: kit elettrico; kit compressore; kit ventilatore; kit valvola di espansione; kit evaporatore; kit pompa; kit tanica acqua;
- ricambi sciolti.

*Per garantire la piena efficienza, le valvole di sicurezza devono essere verificate periodicamente. Nel tempo, le impurità possono depositarsi in prossimità dell'otturatore; è quindi necessario un lavaggio periodico della sede. Tale lavaggio si ottiene producendo uno scarico manuale della valvola, ruotando la manopola nel senso indicato dalle frecce.

Importante: assicurarsi, dopo questa operazione, di ripristinare la pressione di esercizio.

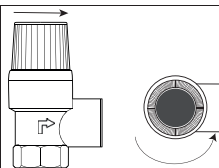



** Durante la manutenzione periodica deve essere verificato anche l'impianto elettrico a bordo macchina ed il quadro elettrico in conformità alla legislazione locale. In aggiunta eseguire sempre

il controllo visivo esterno delle apparecchiature ed i conduttori elettrici dove possibile, deve essere verificato anche il corretto serraggio dei morsetti dei componenti di potenza, secondo le coppie di serraggio prescritte nello schema elettrico.

5.4 Smantellamento

Il fluido frigorifero e l'olio lubrificante contenuto nel circuito dovranno essere recuperati in conformità alle locali normative ambientali vigenti.

Il recupero del fluido refrigerante è effettuato prima della distruzione definitiva dell'apparecchiatura ((UE) N. 517/2014 art.8).

	Riciclaggio Smaltimento 
carpenteria	acciaio/resine epossidi-poliestere
serbatoio	alluminio/rame/acciaio
tubazioni/collettori	rame/alluminio/acciaio al carbonio
isolamento tubazioni	gomma nitrilica (NBR)
compressore	acciaio/rame/alluminio/olio
condensatore	acciaio/rame/alluminio
pompa	acciaio/ghisa/ottone
ventilatore	alluminio
refrigerante	R513A
valvole	ottone/rame
cavi elettrici	rame/PVC

Ai sensi dell' art.26 del Decreto Legislativo 14 marzo 2014 , n.49 . Attuazione della Direttiva 2012/19/UE sui rifiuti di apparecchiature elettriche ed elettroniche (RAEE)" e dell' art.22 del Decreto Legislativo 188 del 20 novembre 2008 la raccolta differenziata della presente apparecchiatura professionale a fine vita è organizzata e gestita dal produttore nel caso in cui l'apparecchiatura sia stata immessa sul mercato dopo il 31 dicembre 2010 . Nel caso in cui vengano fornite all' utente apparecchiatura nuova equipollente si stabilisce il termine di 15 giorni dalla fornitura della stessa per esercitare il diritto di richiedere il ritiro da parte del produttore .



Per garantire la piena efficienza, le valvole di sicurezza devono essere verificate periodicamente.

Nel tempo, le impurità possono depositarsi in prossimità dell'otturatore; è quindi necessario un lavaggio periodico della sede (p.e. inizio stagione). Tale lavaggio si ottiene producendo uno scarico manuale della valvola, ruotando la manopola nel senso indicato dalle frecce

6 Ricerca guasti

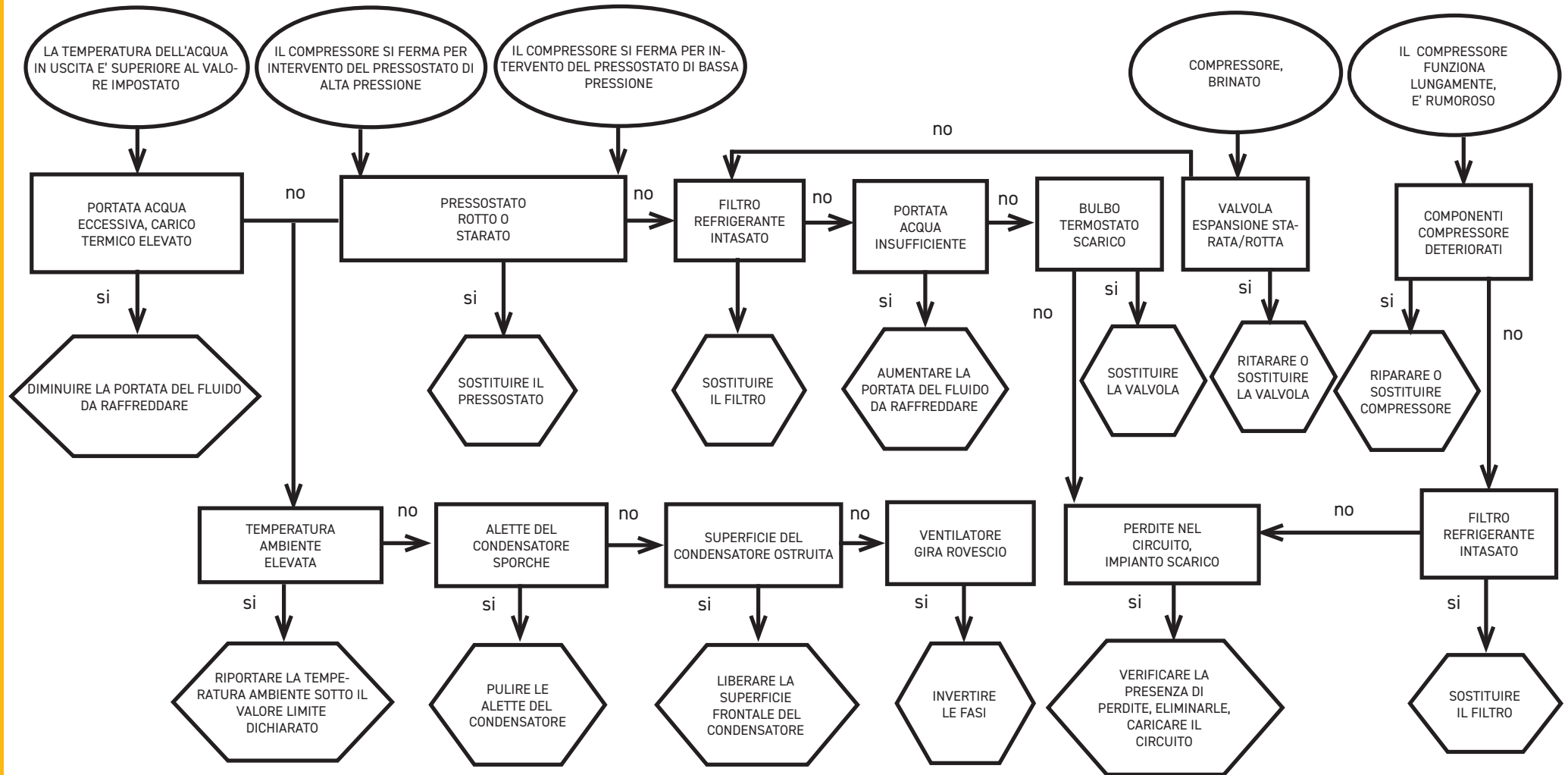
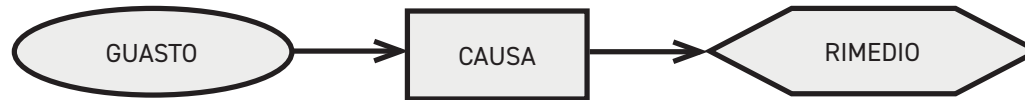

1 Safety	2
1.1 Importance of the manual.....	2
1.2 Warning signals.....	2
1.3 Safety instructions.....	2
1.4 Residual risks.....	2
2 Introduction	3
2.1 Transport.....	3
2.2 Handling.....	3
2.3 Inspection.....	3
2.4 Storage.....	3
3 Installation	3
3.1 Operating space.....	3
3.2 Versions.....	3
3.3 Water circuit.....	3
3.3.1 Checks and connection.....	3
3.3.2 Water and ethylene glycol.....	4
3.3.3 Expansion tank.....	4
3.4 Electrical circuit.....	5
3.4.1 Checks and connections.....	5
3.4.2 General alarm.....	5
3.4.3 ON/OFF remote.....	5
3.5 Water-cooled version (W).....	5
4 Control	6
4.1 Control panel.....	6
4.2 Meaning symbols.....	6
4.3 Starting the chiller.....	6
4.3.1 Adjustments at commissioning.....	6
4.3.2 Starting with high temperature water.....	6
4.4 Stopping the chiller.....	7
4.5 Parameter settings.....	7
4.5.1 Chiller parameters (CF9).....	7
4.5.2 Temperature control (CNP).....	7
4.5.3 Maintenance parameters (MNT).....	7
4.5.4 Probe parameters (BE I, BE2).....	7
4.5.5 Alarm history (RLH I).....	7
4.6 Change parameters (User).....	8
4.6.1 Chiller parameters "CF9".....	8
4.6.2 Temperature control "CNP".....	13
4.6.3 Probe parameter "BE I".....	14
4.7 Visualization probes/fan/compressor.....	14
4.8 Setting clock/date.....	15
4.9 Alarm management.....	16
4.10 Alarm history.....	17
5 Maintenance	17
5.1 General instructions.....	17
5.2 Refrigerant.....	17
5.3 Preventive Maintenance Programme.....	18
5.4 Dismantling.....	18

7 Appendix





7.1 Legend
7.2 Installation diagram
7.3 Handling, operating space
7.4 Technical data
7.5 Dimensions
7.6 Spare parts
7.7 Exploded drawings
7.8 Circuit diagram
7.9 Wiring diagram

1 Safety

1.1 Importance of the manual

- Keep it for the entire life of the machine.
- Read it before any operation.
- It is subject to changes: for updated information see the version on the machine.

1.2 Warning signals

	Instruction for avoiding danger to persons.
	Instruction for avoiding damage to the equipment.
	The presence of a skilled or authorized technician is required.
	There are symbols whose meaning is given in the para. 7.

1.3 Safety instructions

 Every unit is equipped with an electric disconnecting switch for operating in safe conditions. Always use this device in order to eliminate risks maintenance.

 **The manual is intended for the end-user, only for operations performable with closed panels: operations like installation/commissioning/maintenance or that requiring opening with tools must be carried out by skilled and qualified personnel.**

 **For installation only in locations not accessible to general public either in a secured location with restricted access or at a level not less than 2,5 m or in secured rooftop areas, unless they have been given supervision or instruction concerning use of the appliance by a person responsible for their safety.**



 The installation distance from the wall and the free operating space is indicated on par.7.3.

 **Attention: respect the Min./Max temperature and pressure indicated on par. 7.4, and the Overall operation temperature range indicated on par. 7.2.**

 All the units could be installed outdoor.

 **All electrical connections must comply with the applicable regulations in force in the country of installation.**

 Do not exceed the design limits given on the dataplate.

  It is the user's responsibility to avoid loads different from the internal static pressure. The unit must be appropriately protected whenever risks of seismic phenomena exist. Only use the unit for professional work and for its intended purpose.

 The user is responsible for analysing the application aspects for product installation, and following all the applicable industrial and safety standards and regulations contained in the product instruction manual or other documentation supplied with the unit. Tampering or replacement of any parts by unauthorised personnel and/or improper machine use exonerate the manufacturer from all responsibility and invalidate the warranty. The manufacturer declines and present or future liability for damage to persons, things and the machine, due to negligence of the operators, non-compliance with all the instructions given in this manual, and non-application of current regulations regarding safety of the system. The manufacturer declines any liability for damage due to alterations and/or changes to the packing. It is the responsibility of the user to ensure that the specifications provided for the selection of the unit or components and/or options are fully comprehensive for the correct or foreseeable use of themachine itself or its components.

 **IMPORTANT: The manufacturer reserves the right to modify this manual at any time. For the most comprehensive and updated information, the user is advised to consult the manufacturer.**

1.4 Residual risks

The installation, start up, stopping and maintenance of the machine must be performed in accordance with the information and instructions given in the technical documentation supplied and always in such a way to avoid the creation of a hazardous situation. The risks that it has not been possible to eliminate in the design stage are listed in the following table.

part affected	residual risk	manner of exposure	precautions
heat exchanger coil	small cuts	contact	avoid contact, wear protective gloves
fan grille and fan	lesions	insertion of pointed objects through the grille while the fan is in operation	do not poke objects of any type through the fan grille or place any objects on the grille
inside the unit: compressor and discharge pipe	burns	contact	avoid contact, wear protective gloves
inside the unit: metal parts and electrical wires	intoxication, electrical shock, serious burns	defects in the insulation of the power supply lines upstream of the electrical panel; live metal parts	adequate electrical protection of the power supply line; ensure metal parts are properly connected to earth

part affected	residual risk	manner of exposure	precautions
outside the unit: area surrounding the unit	intoxication, serious burns	fire due to short circuit or overheating of the supply line upstream of the unit's electrical panel	ensure conductor cross-sectional areas and the supply line protection system conform to applicable regulations

2 Introduction

The fan, pump and compressor motors are equipped with a thermal protector that protects them against possible overheating.

2.1 Transport

The packed unit must remain:

- Upright.
- Protected against atmospheric agents.
- Protected against impacts.

2.2 Handling

Use a fork-lift truck suitable for the weight to be lifted, avoiding any type of impact.

2.3 Inspection

- All the units are assembled, wired, charged with refrigerant and oil and tested in the factory.
- On receiving the machine check its condition: immediately notify the transport company in case of any damage.
- Unpack the unit as close as possible to the place of installation.

2.4 Storage

- Keep the unit packed in a clean place protected from damp and bad weather.
- Do not stack the units.
- Follow the instructions given on the package.

3 Installation

 For correct installation, follow the instructions given in par.7.

 The product installed must be suitably protected against fire risk (ref. EN378-3).

 **It is recommended that all chillers be fitted with adequate pre-filtration near the inlet water to the chiller (grade of filtration : min.05mm; max1.0mm).**

 **Liquids to be chilled**

The liquids to be chilled must be compatible with the materials used.

Examples of liquids used are water or mixtures of **water and ethylene or propylene glycols or oil**.

The liquids to be chilled must not be flammable.

If the liquids to be chilled contain hazardous substances (e.g. ethylene/propylene glycol), any liquid discharged from a leakage area must be collected, because it is harmful to the environment. When draining the hydraulic circuit, comply with the current regulations and do not disperse the contents in the environment.

3.1 Operating space

 **Leave a space of 1.5 m around the unit.**

Leave a space of at least 2 metres above the refrigerator in models with vertical emission of condensation air.

3.2 Versions

Air version: Axial fans (A)

Do not create cooling air recirculation situations.

Do not obstruct the ventilation grilles.

The ducting of extracted air is not recommended for versions with axial fans.

Water version (W)

If the water to the condenser is in opencircuit, install a meshfilter on the condensation water inlet.

Please note that for special cooling water types such as demineralized, deionized or distilled it is necessary to contact the manufacturer to verify which kind of condenser should be used since the standard material may not be suitable.

3.3 Water circuit

3.3.1 Checks and connection

 Before connecting the chiller and filling the circuit, check that all the pipes are clean. If not, wash them out thoroughly.

  **If the plumbing circuit is of the closed type, under pressure it is install a safety valve set to: 6 bar.**

 Always install mesh filters on the water inlet and outlet pipelines.

 If the hydraulic circuit is intercepted by automatic valves, protect the pump with an anti-hammering system.

 If the hydraulic circuit is emptied for shut-down periods we recommend that you add lubricating fluid to the pump's impeller to avoid the risk of blockage when it is re-started. In case the impel-

ler is blocked then you should unblock it manually.

Remove the rear cover of the pump and carefully turn the plastic fan. If the impeller is stuck then remove the fan and turn the impeller shaft directly. After un-blocking the impeller re-assemble the fan and cover.

Preliminary checks

1. Check that any shut-off valves in the hydraulic circuit are open.
2. In the case of a closed water circuit, check that an expansion tank of suitable capacity has been installed.

Connection

1. Connect the cooler to the inlet and outlet piping, using the special connections located on the back of the unit.

We recommend the use of flexible unions to reduce system rigidity.

2. Fill the water circuit using the fitting provided on the rear of the chiller ().
3. The tank is equipped with a breather valve that should be operated manually when filling the tank. Also, if the hydraulic circuit has high points, install a vent valve at the highest points.
4. We recommend that taps are installed on the inlet and outlet pipes, so that the unit can be excluded for maintenance when necessary.
5. If the chiller works with an open tank, the pump must be installed on intake to the tank and on delivery to the chiller.

 **Warning (models 022-120): the machine is equipped with an automatic protection device for the tank.**



If the water inlet is inadvertently closed when the pump is running and the water outlet is open, air will enter the tank with the probable intervention of the level sensor. It will be necessary to vent the hydraulic circuit to eliminate the air.

Subsequent checks

1. Check that the tank and the circuit are completely full of water and that all the air has been expelled from the system.
2. The water circuit must always be kept full. For this reason, carry out periodic checks and top the circuit up if necessary, or install an automatic filling kit.

Water characteristics

If not provided in the supply, fit a mesh filter on the water inlet

  Water characteristics:

Temperature	≥50°F (10°C)	CL	<50 ppm
ΔT IN/OUT	5-15°C	CaCO ₃	70-150 ppm
Max % glycol	50	O ₂	<0.1 ppm
Pressure	43.5-145 PSig (3-10 barg)	Fe	<0.2 ppm
PH	7.5-9	NO ₃	<2 ppm
Electrical conductivity	10-500 μS/cm	HCO ₃ ⁻	70-300 ppm
Langelier saturation index	0-1	H ₂ S	<0.05 ppm
SO ₄ ²⁻	<50 ppm	CO ₂	<5 ppm
NH ₃	<1 ppm	Al	<0.2 ppm

Please note that for special water types such as demineralized, deionized or distilled it is necessary to contact the manufacturer to verify which kind of chiller should be used since the standard material

may not be suitable.

3.3.2 Water and ethylene glycol

If installed outdoors or in an unheated indoor area, it is possible that the water in the circuit may freeze if the system is not in operation during the coldest times of the year.

To reduce this hazard:

- Equip the chiller with suitable antifreeze protection devices, available from the manufacturer as optional accessories.
- Drain the system via the drain valve if the chiller is to remain idle for a prolonged period.
- Add an appropriate quantity of antifreeze to the water in circulation (see table).

Outlet water temperature [°C]	Ethylene glycol (% vol.)	Ambient temperature
4	5	-2
2	10	-5
0	15	-7
-2	20	-10
-4	25	-12
-6	30	-15
-10	40	-20

3.3.3 Expansion tank

To avoid the possibility of an increase or decrease in the volume of the fluid due to a significant change in its temperature causing damage to the machine or the water circuit, we recommend installing an expansion tank of suitable capacity.

The expansion tank must be installed on intake to the pump on the rear connection of the tank.

The minimum volume of an expansion tank to be installed on a closed circuit can be calculated using the following formula:

$$V=2 \times V_{tot} \times (P_{t \min} - P_{t \max})$$

where

V_{tot} = vol. circuit total (in litres)

$P_{t \min}/P_{t \max}$ = specific weight at the minimum/maximum temperature reached by the water [kg/dm³].

The specific weight values at different temperatures for glycol percentage values are given in the table

% glycol	Temperature [°C]						
	-10	0	10	20	30	40	50
0%	1.0024	1.0008	0.9988	0.9964	0.9936	0.9905	0.9869
10%	1.0177	1.0155	1.0130	1.0101	1.0067	1.0030	0.9989
20%	1.0330	1.0303	1.0272	1.0237	1.0199	1.0156	1.0110
30%	1.0483	1.0450	1.0414	1.0374	1.0330	1.0282	1.0230
40%	1.0636	1.0594	1.0525	1.0511	1.0461	1.0408	1.0350

 **Caution: When filling the system, take into account the capacity of the expansion vessel as well. If the ambient air temperature at the chiller is less than -10°C then you must move the expansion tank to a protected ambient close on the water return side of the chiller. The safety valve and bleed valve must remain at the chiller.**

3.4 Electrical circuit

3.4.1 Checks and connections

 Before carrying out any operation on the electrical system, make sure that the appliance is disconnected from the electrical power supply. All electrical connections must comply with the applicable regulations in force in the country of installation.

Initial checks

1. The power supply voltage and frequency must correspond to the values stamped on the chiller nameplate. The power supply characteristics must not deviate, even for brief periods, from the tolerance limits indicated on the electrical diagram, which are +/- 10% for the voltage; +/- 1% for the frequency.
2. The power supply must be symmetrical (the effective voltages and the phase angles of consecutive phases must be equal). The maximum permissible voltage imbalance is 2%

Connection

1. The electrical power supply must be connected to the chiller using a 4-wire cable, comprising 3 phase conductors and an earth conductor, with no neutral. For minimum cable section, see par. 7.
2. Pass the cable through the cable entry on the rear panel of the machine and connect the phase and neutral to the terminals of the main isolator switch (QS); connect the earth wire to the earth terminal (PE).
3. Ensure that supply cable has at its source protection against direct contact of at least IP2X or IPXXB.
4. On the supply line to the chiller, install a residual-current circuit breaker with a trip rating of (RCCB - IDn = 0.3A), with the current rating indicated in the reference electrical diagram, and with a short circuit current rating appropriate to the short circuit fault current existing in the machine installation area.
The nominal current In of the magnetic circuit breaker must be equal to the FLA with an intervention curve type D.
5. Max. grid impedance value = 0.274 ohm.

Subsequent checks

Check that the machine and the auxiliary equipment are earthed and protected against short circuit and/or overload.

 **Once the unit has been connected and the upstream main switch closed (thereby connecting the power supply to the machine), the voltage in the electrical circuit will reach dangerous levels. Maximum caution is required!**

 **It is the responsibility of the installer to conduct the mandatory minimum tests to ensure proper electrical installation in accordance with local regulations and in coordination with the relevant grounding system, including specific requirements for isolated neutral systems (IT).**

3.4.2 General alarm

All the chillers are equipped with an alarm signalling system (see electrical diagram), comprised of a switching free contact in a terminal block: this may be used for the connection of an external audible or visual alarm, or used to provide an input signal for a logic control system such as a PLC.

3.4.3 ON/OFF remote

All the chillers can be connected to a remote ON/OFF control (par.7.):

- To enable the remote rif. n.16387
- As reference variable ON/OFF rif.n.8996

Note: do not enable together "Sup" and "Re" .

See the electrical diagram for the connection of the remote ON-OFF (par.7.)

3.5 Water-cooled version (W)

In the water-cooled version, the chillers require a water circuit that takes the cold water to condenser. The water version chiller is equipped with a pressure regulating valve at the condenser inlet, whose function is to regulate the water flow in order to always obtain optimum condensation.

Preliminary checks

If the water supply to the condenser is by means of a closed circuit, perform all the preliminary checks listed for the main water circuit (para. 3.3.1).

Connection

1. It is advisable to equip the cooling water circuit with shutoff valves, enabling the machine to be cut out in case of maintenance.
2. Connect the water delivery/return pipes to the special connections located on the back of the unit.
3. If the cooling water is "expendable" it is advisable to equip the circuit with a filter at the condenser inlet, in order to reduce the risk of the surfaces becoming dirtied.
4. If the circuit is of the closed type, make sure it is filled with water and the air properly vented.

4 Control

4.1 Control panel



UP button: press to increment the value of a selected, editable parameter.



DOWN button: press to decrement the value of a selected, editable parameter.



ESC button : to exit without saving; returns to the previous level;

PRESSED FOR 5s. ALARM RESET.



SET button : to exit and saving/ confirm the value; go to the next level; enter on Set Menu;

PRESSED FOR 5s. START CHILLER.

4.2 Meaning symbols

Symbol	Symbol status	function	Symbol	Symbol status	function	
	Lit up	Compressor ON		Lit up	Temperature value	
	Flashing	Compressor stand_by			Lit up	Pressure value
	Off	Compressor Off				Lit up
	Lit up	Allarm present	Off	Antefreeze heater Off		
	Flashing	Warning or Alarm resetable		Lit up		Crankcase heater ON Compressor 1
Off	No alarm	Off		Crankcase heater Off Compressor 1		
	Lit up	Pump 1 ON		Lit up	Crankcase heater ON Compressor 2 (not present)	
	Off	Pump 1 Off		Off	Crankcase heater Off Compressor 2 (not present)	
	Lit up	Pump 2 ON (not present)		Lit up	Crankcase heater ON Compressor 2 (not present)	
	Off	Pump 2 Off (not present)		Off	Crankcase heater Off Compressor 2 (not present)	

4.3 Starting the chiller

1. Connect the power supply to the machine by turning the main isolator switch QS to ON.
2. Press the button "set" to start up.
3. Set the desired temperature on the controller. (par. 4.5.1)

Phases Monitor

If appears on display the alarm "E123", during the start up, the user must verify the wiring of the input terminals of the disconnecting switch.

4.3.1 Adjustments at commissioning

1. Water temperature setting, see heading 4.5.
2. Regulation of th pump
Verify correct operation of the pump, using the pressure gauge (read P1 and P0) and checking the pressure limit values (Pmax and Pmin) indicated on the pump data plate.
P1 = pressure with pump ON
P0 = pressure with pump OFF
 $Pmin < (P1-P0) < Pmax$
- Example n°1.
Conditions:
closed circuit, pressure P0 = 2 bar
pump data plate values: Pmin 1 bar/ Pmax 3 bar
adjust the valve outlet to give a pressure of 3 bar $< P1 < 5$ bar
- Example n°2.
Conditions:
open circuit, pressure P0 = 0 bar
pump data plate values: Pmin 1 bar/ Pmax 3 bar
adjust the valve outlet to give a pressure of 1 bar $< P1 < 3$ bar
3. Verify correct operation of the pump similarly under normal running conditions.
Check also that the amperage of the pump is within the limits indicated on the data plate.
4. Switch off the chiller and proceed to top up the hydraulic circuit at the "SET" temperature.
5. Check that the temperature of the "treated" water does not fall below 5 °C and that the ambient temperature in which the hydraulic circuit operates does not fall below 5 °C. If the temperature is too low, add the appropriate quantity of glycol, as explained under heading 3.3.3.



ATTENTION !: before switching on the chiller pump, close the water outlet valve.

Always keep the possible inlet valve open, if present.

After switching on the pump, slowly open the chiller water outlet valve and adjust the flow rate as described in point 4.3.1.

4.3.2 Starting with high temperature water

In case the water temperature circuit is high (for example, 30-35°C), progressively close (but not completely, about two thirds!) the shut-off valve (at customer care) at the chiller outlet in order to reduce the flow of water through the unit. Gradually open the valve as soon the water temperature decreases to the operating value.

Important: in this condition there may occur multiple high pressure alarms which must be manually reset.

Important: this adjustment also allows you to avoid water hammer along the pipes due to air pockets present in the circuit (air pockets have to be eliminated through air bleed valves at the highest points in the hydraulic circuit at the customer's care).

4.4 Stopping the chiller

When chiller operation is no longer required, turn the chiller off as follows: press the button "set" (5 Sec.).

Do not turn off the main switch QS to ensure that any antifreeze protection devices will still receive electrical power.

4.5 Parameter settings

General

There are two levels of protection for parameters:

- Direct User-(U): with immediate access, **User-changeable**;
- Password protected Service-(S): password required for access, **(do not change)**.

4.5.1 Chiller parameters (CF9)

PARAMETER	CODE	TYPE	DEFAULT
Unit of measurement.	R1	U	OFF
Alarm relay management	CFJ1	U	0
Restore default parameters	DEF	U	OFF
Remote on / off enabling	R7	U	0
Software version	UEr	U	1.69
Unit adress	CF30	U	1
Baud rate	CF31	U	5
Modbus protocol	CF32	U	1
Supervisor on / off enabling	SUP	U	OFF
Dinamic set point enabling	ErD	U	OFF

4.5.2 Temperature control (CNP)

PARAMETER	CODE	TYPE	DEFAULT
Temperature control set point (standard)	SEt	U	13.0
Temperature control set point (precision control)	SEt	U	20.0
Temperature control differential (NOT present in configuration "precision control")	dIF1	U	4.0

4.5.3 Maintenance parameters (Mnt)

PARAMETER	CODE	TYPE	DEFAULT
Unit working hours	UH	U	-
Unit working hours (X1000)	UHL	U	-
Unit partial working hours	UPH	U	-
Unit partial working hours (X1000)	UPHL	U	-
Compressor working hours 1	CIH	U	-
Compressor working hours 1 (x1000)	CIHL	U	-

4.5.4 Probe parameters (bt 1, bt2)

Probe (bt 1)

PARAMETER	CODE	TYPE	DEFAULT
High temperature alarm (water)	HR1	U	60

Probe (bt2)

PARAMETER	CODE	TYPE	DEFAULT
High temperature alarm (water)	HR2	U	60







4.5.5 Alarm history (ALH i)

PARAMETER	CODE	TYPE	DEFAULT
Alarm number	HYSP	U	-
See alarm code	HYSC	U	-
See day and month of the alarm	HYSD	U	-
See hour and minutes of the alarm	HYSt	U	-
bt1 temperature at time of the alarm	HY51	U	-
bt2 temperature at time of the alarm	HY52	U	-
SET conditions at time of the alarm	HY53	U	-









4.6 Change parameters (User)

4.6.1 Chiller parameters "CF9"

Unit of measurement.

Switch ON the chiller "ON" using the Main disconnect switch QS, and wait on display the indication "OFF". Press the buttons "esc" "set" together to enter on "U" parameters.	
Parameter "PAR" appears. Press the button "set" to enter.	
Parameter "CF9" appears. Press the button "set" to enter.	
Parameter "R1" appears. Press the button "set" to enter	
The default value is "OFF" = °C Use the buttons "↓" and "↑" to select the unit of measurement. OFF : temperature = C°, Celsius ; pressure = Bar; On : temperature = °F, Fahrenheit; Pressure =PSI	
Press the button "set" to confirm.	
Automatically return to "R1" The parameter has now been stored. Press the button "esc" to exit, three time.	

Alarm management

Switch ON the chiller "ON" using the Main disconnect switch QS, and wait on display the indication "OFF". Press the buttons "esc" "set" together to enter on "U" parameters.	
Parameter "PAR" appears. Press the button "set" to enter.	
Parameter "CF9" appears. Press the button "set" to enter.	
Parameter "R1" appears. Use the buttons "↓" and "↑" to select "CFJ1" parameter.	
Press the button "set" to enter.	
The default value is "0" Use the buttons "↓" and "↑" to select the alarm relay management (par. 4.5.1- Tab.1)	
Press the button "set" to confirm.	
Automatically return to "CFJ1" The parameter has now been stored. Press the button "esc" to exit, three time.	

Tab.1 Alarm relay management (CFJ1.)

0	Relay normally deactivated, excited by an alarm.
1	Relay normally excited (also with control OFF), deactivated by an alarm.
2	Relay normally excited (only with control ON), deactivated by an alarm or with control OFF.

Default parameters

Switch ON the chiller "ON" using the Main disconnect switch QS, and wait on display the indication "OFF". Press the buttons "esc" "set" together to enter on "U" parameters.	
Parameter "PAR" appears. Press the button "set" to enter.	
Parameter "CF9" appears. Press the button "set" to enter.	
Parameter "A1" appears. Use the buttons "down arrow" and "up arrow" to select "dEF" parameter.	
Press the button "set" to enter.	
The default value is "OFF". Use the buttons "down arrow" and "up arrow" to change from "OFF" to "On".	
Press the button "set" to confirm.	
After few seconds return to "OFF". The parameters were automatically reset. Press the button "esc" to exit, three time.	







Remote ON/OFF

Switch ON the chiller "ON" using the Main disconnect switch QS, and wait on display the indication "OFF". Press the buttons "esc" "set" together to enter on "U" parameters.	
Parameter "PAR" appears. Press the button "set" to enter.	
Parameter "CF9" appears. Press the button "set" to enter.	
Parameter "A1" appears. Use the buttons "down arrow" and "up arrow" to select "A7" parameter.	
Press the button "set" to enter.	
The default value is "0". Use the buttons "down arrow" and "up arrow" to select the mode: (par. 4.5.1- Tab.2)	
Press the button "set" to confirm.	
Automatically return to "A7". The parameter has now been stored. Press the button "esc" to exit, three time.	









Tab.2 Remote On / Off mode (A7)

0	Remote On/Off disabled
1	Remote On/Off enabled together with local On/Off. In case of loss of power, or the main switch is turned off, then, on return of power the chiller must be restarted locally
2	Remote On/Off only, local On/Off disabled









Software version

Switch ON the chiller "ON" using the Main disconnect switch QS, and wait on display the indication "OFF". Press the buttons "esc" "set" together to enter on "U" parameters.	
Parameter "PAR" appears. Press the button "set" to enter.	
Parameter "CF9" appears. Press the button "set" to enter.	
Parameter "A i" appears. Use the buttons "⏪" and "⏩" to select "UEr" parameter.	
Press the button "set" to enter.	
The software version is shown	
Press the button "esc" to exit, three time.	







Supervisor enabling

Switch ON the chiller "ON" using the Main disconnect switch QS, and wait on display the indication "OFF". Press the buttons "esc" "set" together to enter on "U" parameters.	
Parameter "PAR" appears. Press the button "set" to enter.	
Parameter "CF9" appears. Press the button "set" to enter.	
Parameter "A i" appears. Use the buttons "⏪" and "⏩" to select "SUP" parameter.	
Press the button "set" to enter.	
The default value is "OFF" Use the buttons "⏪" and "⏩" to change.	
Press the button "set" to confirm.	
The parameter has now been stored. Press the button "esc" to exit, three time.	

Modbus (address)

Switch ON the chiller "ON" using the Main disconnect switch QS, and wait on display the indication "OFF". Press the buttons "esc" "set" together to enter on "U" parameters.	
Parameter "PAr" appears. Press the button "set" to enter.	
Parameter "CF9" appears. Press the button "set" to enter.	
Parameter "A i" appears. Use the buttons "⏪" and "⏩" to select "CF30" parameter.	
Press the button "set" to enter.	
The default value is "1" Use the buttons "⏪" and "⏩" to change the address.	
Press the button "set" to confirm.	
The parameter has now been stored. Press the button "esc" to exit, three time.	

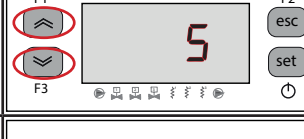







Modbus (baud rate)

Switch ON the chiller "ON" using the Main disconnect switch QS, and wait on display the indication "OFF". Press the buttons "esc" "set" together to enter on "U" parameters.	
Parameter "PAr" appears. Press the button "set" to enter.	
Parameter "CF9" appears. Press the button "set" to enter.	
Parameter "A i" appears. Use the buttons "⏪" and "⏩" to select "CF31" parameter.	
Press the button "set" to enter.	
The default value is "5" Use the buttons "⏪" and "⏩" to change the protocol. (par. 4.5.1- Tab.3)	
Press the button "set" to confirm.	
The parameter has now been stored. Press the button "esc" to exit, three time.	

Tab.3 Baud rate (opzional)(CF3 i)

1	2400	3	9600	5	38400	7	115200
2	4800	4	19200	6	57600		

Modbus (protocol)









Switch ON the chiller "ON" using the Main disconnect switch QS, and wait on display the indication "OFF". Press the buttons "esc" "set" together to enter on "U" parameters.	
Parameter "PAR" appears. Press the button "set" to enter.	
Parameter "CF9" appears. Press the button "set" to enter.	
Parameter "A i" appears. Use the buttons "down" and "up" to select "CF32" parameter.	
Press the button "set" to enter.	
The default value is "1" Use the buttons "down" and "up" to change the baud rate. (par. 4.5.1- Tab.4)	
Press the button "set" to confirm.	
The parameter has now been stored. Press the button "esc" to exit, three time.	

Tab.4 Protocol modbus (opzional)(CF32)

1	EVEN	2	NONE	3	ODD
---	------	---	------	---	-----

 **Note:** if you change the MODBUS parameters, to validate the new parameters you must turn OFF the chiller and then turn it back ON again.









ERD enabling

Switch ON the chiller "ON" using the Main disconnect switch QS, and wait on display the indication "OFF". Press the buttons "esc" "set" together to enter on "U" parameters.	
Parameter "PAR" appears. Press the button "set" to enter.	
Parameter "CF9" appears. Press the button "set" to enter.	
Parameter "A i" appears. Use the buttons "down" and "up" to select "SUP" parameter.	
Press the button "set" to enter.	
The default value is "OFF" Use the buttons "down" and "up" to change.	
Press the button "set" to confirm.	
The parameter has now been stored. Press the button "esc" to exit, three time.	

 **With ERD parameter enable:** The water set temperature change on referring the ambient temperature. The function is only active if the temperature precision control is disabled (CPT=OFF).

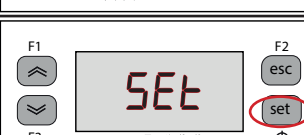



4.6.2 Temperature control "CNP"

Temperature control setting

Switch ON the chiller "ON" using the Main disconnect switch QS, and wait on display the indication "OFF". Press the buttons "esc" "set" together to enter on "U" parameters.	
Parameter "PAR" appears. Press the button "set" to enter.	
Parameter "CF9" appears. Use the buttons "down" and "up" to select "CNP" parameter.	
Press the button "set" to enter.	
Parameter "SEt" appears. Press the button "set" to enter.	
The default value is "13.0" Use the buttons "down" and "up" to change the value.	
Press the button "set" to confirm.	
The parameter has now been stored. Press the button "esc" to exit, three time.	

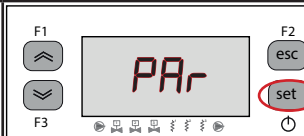
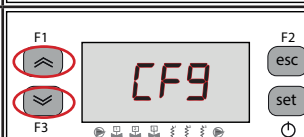
Important: A set of temperature between 1°C and 5°C, must be done by specialised technicians that must use the specific service manual of this product.

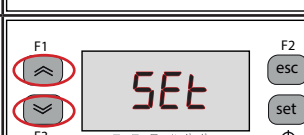
Temperature control differential setting

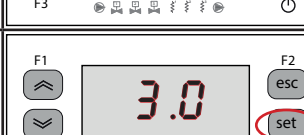
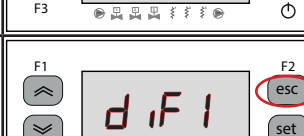
Switch ON the chiller "ON" using the Main disconnect switch QS, and wait on display the indication "OFF". Press the buttons "esc" "set" together to enter on "U" parameters.	
Parameter "PAR" appears. Press the button "set" to enter.	
Parameter "CF9" appears. Use the buttons "down" and "up" to select "CNP" parameter.	
Press the button "set" to enter.	
Parameter "SEt" appears. Use the buttons "down" and "up" to select "dIF" parameter.	
Press the button "set" to enter.	
The default value is "4.0" Use the buttons "down" and "up" to change the value.	
Press the button "set" to confirm.	
The parameter has now been stored. Press the button "esc" to exit, three time.	

4.6.3 Probe parameter "bt 1"

Probe "bt 1".

Switch ON the chiller "ON" using the Main disconnect switch QS, and wait on display the indication "OFF".

Press the buttons "esc" "set" together to enter on "U" parameters.



Parameter "PAR" appears.

Press the button "set" to enter.



Parameter "CF9" appears.

Use the buttons "down" and "up" to select "bt 1" parameter.



Press the button "set" to enter.



Parameter "HA 1" appears.

Press the button "set" to enter.



The default value is "60.0"

Use the buttons "down" and "up" to change the value.

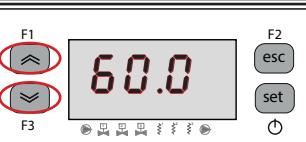

Press the button "set" to confirm.



The parameter has now been stored.

Press the button "esc" to exit, three time.



Same sequence for probe "bt2".

4.7 Visualization probes/fan/compressor

Chiller in operation.

Press the button "up" to see the probes
bt 1, bt 2, bt 3, bP 1.....



Select the probe and wait some seconds. (Es. BT2)



Value of the probe bt 2 appears.

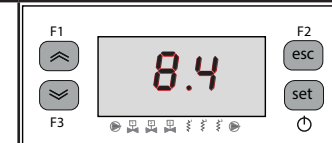

It is advisable to always return to probe bt 1



Description:

bt 1 : water outlet temperature sensor

bt 2 : evaporator temperature sensor

bt 3 : ambient temperature sensor

bt 10 : electrical panel temperature sensor (option)

bP 1 : circuit 1 transmitter

bP 2 : circuit 2 transmitter; (from model ICEP080)

F_... : fan operation:

F_... : fan OFF

F-... : fan 1 ON, fan 2,3 OFF: (2 = from model ICEP022) (3 = from model ICEP080)

F--... : fans 1 and 2 ON, fan 3 OFF, (2 = from model ICEP022) (3 = from model ICEP080)

F---... : fans 1,2 and 3 ON (from model ICEP080)

ICE2 : compressors operation:

ICE- : compressors disabled









ICE- : compressors OFF

ICE- : compressor 1 ON, compressor 2 OFF

ICE2 : compressors 1 and 2 ON; (from model ICEP055)

ICE- : with "i" flashing compressor ready to start, compressor 2 OFF

4.8 Setting clock/date

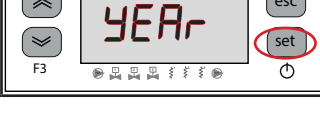
Switch ON the chiller "ON" using the Main disconnector switch QS, and wait on display the indication "OFF". Press the buttons "⏴" "⏵" together to enter on "Data/time" menu.	
Parameter "FrEE" appears. Press the button "set" to enter.	
Parameter "R," appears. Use the buttons "⏴" and "⏵" to select "CL" parameter.	
Press the button "set" to enter.	
Parameter "HOUr" appears. Press for 5 seconds the button "set". Now the parameter is flashing.	
Use the buttons "⏴" and "⏵" to select date, hour or year to change.	
Press the button "set" to enter.	
Use the buttons "⏴" and "⏵" to change the value (es:year)	
Press the button "set" to confirm.	

Use the buttons "⏴" and "⏵" to change another value (es:date)



Press the button "esc" to exit.
The parameter stops flashing.



Press the buttons "⏴" "⏵" together to exit.



⚠ The memory of the "clock / date" has a maximum duration of three days, so if the controller is left without power for more than three days, the data set hour / month / year are lost. Adjust the clock at the start up of the machine, and whenever necessary.

4.9 Alarm management

In the presence of an alarm, alarm code appear and a symbol at the top left

 Continuous = alarm present
Flashing = warning present/ Alarm resettable



Press the button "set" to enter.



Parameter "RLH" appears.

Press the button "" to select "RL" parameter.



Press the button "set" to enter.

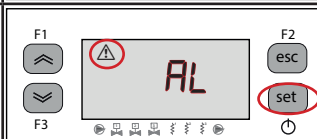

The code alarm appears as: "Er08".

Press the button "" to check if there are more alarms present.



Repair the fault before performing the reset.

Once the fault has been repaired, the alarm symbol begins to flash.

Now you can perform the reset.

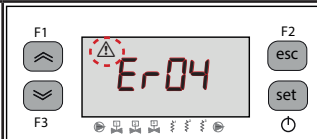





press the button "esc" until the alarm disappears.

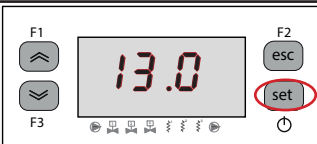

Alarm/warning list

Code	Description	Action	Reset
Er01	Sensor bt1 cutout or broken	Alarm	M
Er02	Sensor bt2 cutout or broken	Alarm	M
Er03	Sensor bt3 cutout or broken	Alarm	A
Er05	Sensor bt10 cutout or broken	Alarm	A
Er06	Sensor bP1 cutout or broken	Alarm	M
Er08	High pressure circuit 1	Alarm	M
Er09	Low pressure circuit 1	Alarm	M
Er12	High temperature bt1	Alarm	M
Er13	Low temperature bt1	Alarm	A
Er14	High temperature bt2	Alarm	M
Er15	Low temperature bt2	Alarm	M
Er16	High temperature bt3	Alarm	A
Er17	Low temperature bt3	Alarm	A
Er18	Compressor thermal protection 1	Alarm	M
Er20	Pump thermal protection 1	Alarm	M
Er22	Low water level / Differential pressure switch	Alarm	M
Er23	Phase monitor	Alarm	M
Er24	Expansion broken or disconnected	Alarm	M
Er25	Exceeded compressor working hours	Warning	M
Er27	Exceeded unit working hours	Warning	M
Er28	Clock Memory	Warning	A
Er29	Chiller configuration	Warning	A

4.10 Alarm history





Chiller in operation. Press the button "set" to see the alarm history.	
Press the button "set" to enter.	
Use the buttons "⏪" and "⏩" to see the parameters. (Par. 4.5.5)	
Press the button "set" to see the value.	

5 Maintenance

• The machine is designed and built to guarantee continuous operation; however, the life of its components depends on the maintenance performed.

-  When requesting assistance or spare parts, identify the machine (model and serial number) by reading the dataplate located on the unit. (www.polewr.com.)

5.1 General instructions

-  Before performing any maintenance, make sure the power to the refrigerator is disconnected.
-  Always use the Manufacturer's original spare parts: otherwise the Manufacturer is relieved of all liability regarding machine malfunctioning.
-  In case of refrigerant leakage, contact qualified and authorized personnel.
-  The Schrader valve must only be used in case of machine malfunction: otherwise any damage caused by incorrect refrigerant charging will not be covered by the warranty.a.

5.2 Refrigerant













Charging: any damage caused by incorrect charging carried out by unauthorized personnel will not be covered by the warranty. 

-  The equipment contains fluorinated greenhouse gases.
At normal temperature and pressure, the R513A refrigerant is a colourless gas classified in SAFETY GROUP A1 - EN378 (group 2 fluid according to Directive PED 2014/68/EU);
GWP (Global Warming Potential) = 629.

-  In case of refrigerant leakage, air the room.

5.3 Preventive Maintenance Programme

To guarantee lasting maximum chiller efficiency and reliability:

Maintenance Activity Description	Maintenance Interval (standard operating conditions)			
	Daily	6 Months	12 Months	36 Months
Activity				
Check  Service 				
Check POWER ON indicator is lit.				
Check control panel indicators				
Clean condenser fins.				
Check electrical absorption				
Check refrigerant leaks				
Check and clean water safety valve (if present)*				
Check the electrical system on the machine and the electrical panel**				
Check temperature sensors Replace if necessary				 
Maintenance kit				



The following are available (see par 7.):

- Service kit: electrical kit; compressor kit; fan kit; expansion valve kit; evaporator kit; pump kit; water tank kit;
- individual spare parts.

*To ensure full efficiency, safety valves must be checked periodically. Over time, impurities can settle near the plug; therefore, periodic flushing of the seat is necessary. Such flushing is achieved by manually draining the valve by turning the knob in the direction indicated by the arrows.

Important: Make sure, after this operation, that the operating pressure is restored.

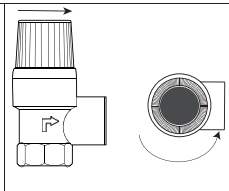



** During the periodic maintenance, the electrical system on the machine and the electrical panel must also be checked in accordance with local legislation. Additionally, a visual inspection of the equipment and electrical conductors should always be performed where possible, and the correct tightening of the terminals of the power components must also be verified, according to the tightening torques specified in the electrical diagram.

5.4 Dismantling

The refrigerant and the lubricating oil contained in the circuit must be recovered in conformity with current local environmental regulations.

The refrigerant fluid is recovered before final scrapping of the equipment ((EU) No. 517/2014 art.8).

	Recycling Disposal 
frame and panels	steel/epoxy resin polyester
tank	aluminium/copper/steel
pipes/collectors	copper/aluminium/carbon steel
pipe insulation	NBR rubber
compressor	steel/copper/aluminium/oil
condensator	steel/copper/aluminium
pump	steel/cast iron/brass
fan	aluminium
refrigerant	R513A
valve	brass/copper
electrical cable	copper/PVC

Equipment containing electrical components must be disposed separately collected with electrical and electronic waste according to local and currently legislation.



6 Troubleshooting

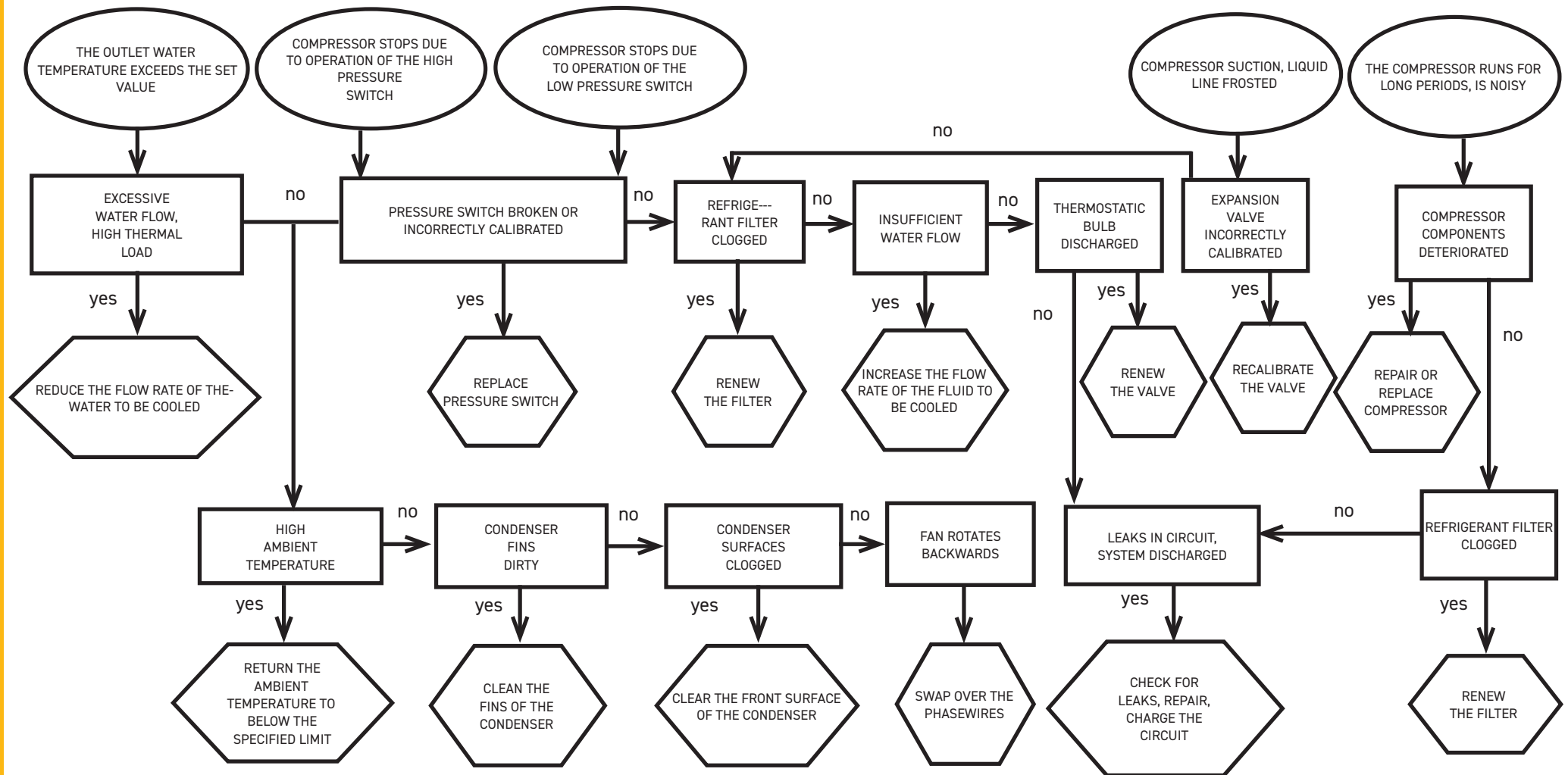

1 Seguridad	2
1.1 Importancia del manual.....	2
1.2 Señales de advertencia.....	2
1.3 Instrucciones de seguridad.....	2
1.4 Riesgos residuales.....	2
2 Introducción	3
2.1 Transporte.....	3
2.2 Traslado.....	3
2.3 Inspección.....	3
2.4 Almacenaje.....	3
3 Instalación	3
3.1 Espacio operativo.....	3
3.2 Versiones.....	3
3.3 Circuito hidráulico.....	3
3.3.1 Controles y conexionado.....	3
3.3.2 Agua y etilenglicol.....	4
3.3.3 Vaso de expansión.....	4
3.4 Circuito eléctrico.....	5
3.4.1 Controles y conexionado.....	5
3.4.2 Alarma general.....	5
3.4.3 Encendido y apagado a distancia.....	5
3.5 Versión por agua (W).....	5
4 Control	6
4.1 Panel de control.....	6
4.2 Significado de los símbolos.....	6
4.3 Encendido del enfriador.....	6
4.3.1 Ajustes en la puesta en marcha.....	6
4.3.2 Encendido con agua a alta temperatura.....	6
4.4 Parada del enfriador.....	7
4.5 Parameter settings.....	7
4.5.1 Parámetros del enfriador (CF9).....	7
4.5.2 Control de temperatura (CNP).....	7
4.5.3 Parámetros de mantenimiento (PnE).....	7
4.5.4 Parámetros de la sonda (bE 1, bE2).....	7
4.5.5 Historial de alarmas (ALH i).....	7
4.6 Cambiar parámetros (User).....	8
4.6.1 Parámetros del enfriador "CF9".....	8
4.6.2 Control de temperatura "CNP".....	13
4.6.3 Parámetro de sonda "bE 1".....	14
4.7 Visualización sondas/ventilatos/compresor.....	14
4.8 Ajuste del reloj/calendario.....	15
4.9 Gestión de alarmas.....	16
4.10 Historial de alarmas.....	17
5 Mantenimiento	17
5.1 Advertencias generales.....	17
5.2 Refrigerante.....	17
5.3 Preventive Maintenance Programme.....	18
5.4 Desguace.....	18

7 Apéndice
7.1 Leyenda
7.2 Esquema de instalación
7.3 Espacio operativo -Traslado
7.4 Datos técnicos
7.5 Dibujos de dimensiones
7.6 Lista de repuestos
7.7 Planos de despiece
7.8 Circuitos de refrigerante
7.9 Esquema eléctrico

1 Seguridad

1.1 Importancia del manual

- Consérvelo durante toda la vida útil del equipo.
- Léalo antes de realizar cualquier operación.
- Puede sufrir modificaciones: para una información actualizada, consulte la versión instalada en el equipo.

1.2 Señales de advertencia



Instrucción para evitar peligros personales.



Instrucción para evitar que se dañe el equipo.





Se requiere la intervención de un técnico experto y autorizado.



El significado de los símbolos utilizados se indica en el apartado 7.

1.3 Instrucciones de seguridad

 Todas las unidades están provistas de un seccionador eléctrico que permite trabajar en condiciones de seguridad. Utilícelo siempre durante el mantenimiento.

 El manual está destinado al usuario final y sólo para las operaciones que pueden realizarse con los paneles cerrados. Las operaciones de instalación/puesta en marcha/mantenimiento o que requieren la apertura con herramientas deben ser efectuadas por personal experto y calificado.

 Para instalación únicamente en lugares no accesibles al público, ya sea en un lugar seguro con acceso restringido, a una altura no inferior a 2,5 m o en azoteas seguras, a menos que hayan recibido supervisión o instrucciones sobre el uso del aparato por parte de una persona responsable de su seguridad.

 La distancia de instalación a la pared y el espacio libre de funcionamiento se indican en el par.7.3.

 Atención: Respete la temperatura y presión mínimas y máximas indicadas en el apartado 7.4, así como el rango de temperatura de funcionamiento general indicado en el apartado 7.2.

 Todas las unidades pueden instalarse en exteriores.

 Todas las conexiones eléctricas deben realizarse de conformidad con las disposiciones vigen-

tes en el lugar de instalación.



No supere los límites de proyecto que se indican en la placa de características.



 El usuario debe evitar cargas distintas de la presión estática interna. En caso de riesgo de fenómenos sísmicos, es necesario proteger adecuadamente la unidad.

La unidad debe utilizarse exclusivamente para uso profesional y con el objeto para el cual ha sido diseñada.



El usuario debe analizar todos los aspectos de la aplicación en que el producto se ha instalado, seguir todas las normas industriales de seguridad aplicables y todas las prescripciones relativas al producto descritas en el manual de uso y en la documentación redactada que se adjunta a la unidad. La alteración o sustitución de cualquier componente por parte del personal no autorizado, así como el uso inadecuado de la unidad eximen de toda responsabilidad al fabricante y provocan la anulación de la garantía.

El fabricante declina toda responsabilidad presente o futura por daños personales o materiales derivados de negligencia del personal, incumplimiento de las instrucciones dadas en este manual o inobservancia de las normativas vigentes sobre la seguridad de la instalación.

El fabricante no asume ninguna responsabilidad por daños debidos a alteraciones y/o modificaciones del embalaje.

El usuario es responsable que las especificaciones suministradas para seleccionar la unidad o sus componentes y/o opciones sean exhaustivas para un uso correcto o razonablemente previsible de la misma unidad o de los componentes.



ATENCIÓN: El fabricante se reserva el derecho de modificar sin previo aviso la información de este manual. Para que la información resulte completa, se recomienda al usuario consultar el manual a pie de máquina.

1.4 Riesgos residuales

Las operaciones de instalación, puesta en marcha, apagado y mantenimiento del equipo deben realizarse de total conformidad con lo indicado en la documentación técnica del equipo y de manera tal que no se genere ninguna situación de riesgo.

Los riesgos que no han podido eliminarse con recursos técnicos de diseño se indican en la tabla siguiente.

parte del equipo	riesgo residual	modo	precauciones
batería de intercambio térmico	pequeñas heridas cortantes	contacto	evitar el contacto, usar guantes de protección
rejilla del ventilador y ventilador	lesiones	introducción de objetos puntiagudos en la rejilla mientras el ventilador está funcionando	no introducir ni apoyar ningún objeto en la rejilla de los ventiladores
interior del equipo: compresor y tubo de salida	quemaduras	contacto	evitar el contacto, usar guantes de protección

parte del equipo	riesgo residual	modo	precauciones
interior del equipo: partes metálicas y cables eléctricos	intoxicación, electrocución, quemaduras graves	defecto de aislamiento de los cables de alimentación que llegan al cuadro eléctrico del equipo; partes metálicas en tensión	protección eléctrica adecuada de la línea de alimentación; conectar cuidadosamente a tierra las partes metálicas
exterior del equipo: zona circundante	intoxicación, quemaduras graves	incendio por cortocircuito o sobrecalentamiento de la línea de alimentación del cuadro eléctrico del equipo	sección de los cables y sistema de protección de la línea de alimentación eléctrica conformes a las normas vigentes

2 Introducción

Los motores del compresor, de la bomba y del ventilador están dotados de una protección térmica contra eventuales sobrecalentamientos.

2.1 Transporte

El equipo embalado debe mantenerse:

- posición vertical;
- protegido de los agentes atmosféricos;
- protegido de golpes.

2.2 Traslado

Utilice una carretilla elevadora con horquillas, adecuada para el peso del equipo, y evite todo tipo de golpes.

2.3 Inspección

- Conserve el equipo en un lugar limpio y protegido de la humedad y la intemperie;
- no apilar las unidades;
- seguir las instrucciones presentes en el embalaje.

2.4 Almacenaje

- Keep the unit packed in a clean place protected from damp and bad weather.
- Do not stack the units;
- Follow the instructions given on the package.

3 Instalación

 Para realizar correctamente la instalación, siga las instrucciones dadas en los apartados.7.

 El producto instalado debe estar adecuadamente protegido contra el riesgo de incendio (ref. EN378-3).

 **Se recomienda que todos los enfriadores incorporen un filtrado previo adecuado cerca de la entrada de agua/ aceite (grado de filtración : min.05mm; max1.0mm).**

 **Líquidos que pueden enfriarse**

Sólo pueden enfriarse líquidos que sean compatibles con los materiales empleados.

Algunos de los líquidos usados **son agua o mezclas de agua y etilenglicol o propilenglicol / aceite.**

No se deben enfriar líquidos inflamables.

Si los líquidos a refrigerar contienen sustancias peligrosas (como por ejemplo glicol etilénico/propilénico), hay que recoger el líquido derramado en una zona de fuga porque es perjudicial para el medio ambiente. En caso de vaciado del circuito hidráulico, hay que cumplir con las normas vigentes y evitar la liberación del líquido al medio ambiente.

3.1 Espacio operativo

 **Deje un espacio libre de 1,5 m todo alrededor del equipo.**

Dejar al menos 2 metros de espacio encima del refrigerador en los modelos de expulsión vertical del aire de condensación.

3.2 Versiones

Versión por aire: ventiladores axiales (A)

No cree situaciones que permitan la recirculación del aire de enfriamiento.

No obstruya las rejillas de ventilación.

En las versiones con ventiladores axiales, se desaconseja canalizar el aire agotado.s

Versión por agua (W)

Si el agua del condensador está en circuito abierto, instalar un filtro de malla en la entrada del agua de condensación.

Es posible que los materiales estándar previstos para el condensador no sean adecuados para determinadas aguas de refrigeración (desionizada, desmineralizada, destilada). En estos casos, se ruega ponerse en contacto con el fabricante.

3.3 Circuito hidráulico

3.3.1 Controles y conexionado

 Antes de conectar el enfriador y llenar el circuito, asegurarse de que los tubos estén limpios. De lo contrario, lavarlos cuidadosamente.

  **Si el circuito hidráulico es de tipo cerrado, bajo presión, una válvula de seguridad ajustada a: 6 bar.**

 Se recomienda instalar filtros de red en los tubos de entrada y salida del agua.

 Si el circuito hidráulico posee válvulas automáticas de corte, proteger la bomba con sistemas

contra golpe de ariete.

 Si se vacía el circuito por paradas prolongadas, se recomienda añadir aceite lubricante en el rodete de la bomba para evitar su bloqueo en el arranque siguiente. En caso de bloqueo del rodete, desbloquéelo manualmente.

Quite la tapa posterior de la bomba y gire suavemente el ventilador de plástico. Si el eje siguiera bloqueado, quite el ventilador y actúe directamente en el eje. Una vez desbloqueado el rodete, vuelva a colocar el ventilador y la tapa.

Controles preliminares

1. Cerciorarse de que las válvulas de corte del circuito hidráulico estén abiertas.
2. Si el circuito hidráulico es cerrado, controlar que se haya instalado un vaso de expansión de capacidad adecuada.

Conexión

1. Conectar el refrigerador de agua a los conductos de entrada y salida utilizando los correspondientes empalmes ubicados en la parte trasera de la unidad.
Se aconseja utilizar conexiones flexibles para quitar rigidez al sistema.
2. Llenar el circuito hidráulico utilizando la conexión de carga situada en la parte posterior del enfriador ().
3. El depósito está provisto de un purgador de aire que debe accionarse manualmente a la hora del llenado. Si el circuito hidráulico presenta puntos elevados, instalar una válvula de escape en ellos.
4. Se aconseja instalar válvulas de corte en la entrada y la salida del equipo para poder excluirlo del circuito en caso de mantenimiento.
5. Si el enfriador funciona con cuba abierta, la bomba se debe instalar en el tubo de admisión de la cuba y en el tubo de impulsión al enfriador.

 **Advertencia (modelos 022-120): la máquina está equipada con un dispositivo de protección automática para el tanque.**

Si la entrada de agua se cierra inadvertidamente cuando la bomba está funcionando y la salida de agua está abierta, el aire ingresará al tanque con la probable intervención del sensor de nivel. Será necesario ventilar el circuito hidráulico para eliminar el aire.

Controles sucesivos

1. Controlar que el depósito y el circuito estén completamente llenos de agua y que se haya purgado todo el aire.
2. El circuito hidráulico debe mantenerse siempre lleno. Para ello se debe controlar y rellenar periódicamente, o bien instalar un dispositivo de llenado automático.

Características del agua

Si el suministro no lo incluye, instale un filtro de malla en la entrada del agua.

  Características del agua:

Temperatura	≥50°F (10°C)	CL ⁻	<50 ppm
ΔT IN/OUT	5-15°C	CaCO ₃	70-150 ppm
Max % de glicol	50	O ₂	<0.1 ppm
Presión	43.5-145 PSig (3-10 barg)	Fe	<0.2 ppm
PH	7.5-9	NO ₃	<2 ppm
Conductividad eléctrica	10-500 μS/cm	HCO ₃ ⁻	70-300 ppm
Índice de saturación de Langelier	0-1	H ₂ S	<0.05 ppm

SO ₄ ²⁻	<50 ppm	CO ₂	<5 ppm
NH ₃	<1 ppm	Al	<0.2 ppm

Es posible que los materiales estándar previstos para el refrigerador no sean adecuados para determinadas aguas de refrigeración (desionizada, desmineralizada, destilada). En estos casos, se ruega ponerse en contacto con el fabricante.

3.3.2 Agua y etilenglicol

Si el equipo está instalado en el exterior, o en un local cubierto pero sin calefacción, durante las paradas en los meses más fríos el agua que está dentro del circuito se puede congelar.

Para reducir este riesgo:

- dotar al enfriador de adecuadas protecciones antihielo suministradas como opcionales por el fabricante;
- descargar la instalación a través de la válvula correspondiente, en caso de paradas prolongadas;
- añadir un anticongelante al agua de circulación (ver tabla).

Temperatura agua de salida [°C]	Etilenglicol (% vol.)	Temperatura ambiente
4	5	-2
2	10	-5
0	15	-7
-2	20	-10
-4	25	-12
-6	30	-15
-10	40	-20

3.3.3 Vaso de expansión

Para evitar que los aumentos o las disminuciones de volumen causados por las variaciones de temperatura dañen el equipo o el circuito, es conveniente instalar un vaso de expansión de capacidad adecuada.

El vaso de expansión se instala siempre en el lado de aspiración de la bomba.

El volumen mínimo del vaso de expansión que se debe aplicar a un circuito cerrado se calcula con la fórmula siguiente:

$$V = 2 \times V_{tot} \times (P_{t \text{ mín.}} - P_{t \text{ máx.}})$$

donde

V_{tot} = volumen total del circuito (en litros)

P_{t mín./máx.} = peso específico a la temperatura mínima/máxima que puede alcanzar el agua [kg/dm³].

En la tabla siguiente se indican los pesos específicos en función de la temperatura y del porcentaje de glicol.

% de glicol	Temperatura [°C]						
	-10	0	10	20	30	40	50
0%	1.0024	1.0008	0.9988	0.9964	0.9936	0.9905	0.9869
10%	1.0177	1.0155	1.0130	1.0101	1.0067	1.0030	0.9989
20%	1.0330	1.0303	1.0272	1.0237	1.0199	1.0156	1.0110
30%	1.0483	1.0450	1.0414	1.0374	1.0330	1.0282	1.0230
40%	1.0636	1.0594	1.0525	1.0511	1.0461	1.0408	1.0350

 **Atención: Durante el llenado, tomar como referencia los datos de carga también del depósito de expansión.**

Si la temperatura del aire ambiente en la enfriadora es inferior a $-10\text{ }^{\circ}\text{C}$, debe mover el tanque de expansión a un lugar protegido cerca del lado de retorno de agua de la enfriadora. La válvula de seguridad y la válvula de purga deben permanecer en el enfriador.

3.4 Circuito eléctrico

3.4.1 Controles y conexionado



Antes de realizar cualquier operación en las partes eléctricas, cerciorarse de que no circule corriente.

Todas las conexiones eléctricas deben realizarse de conformidad con las disposiciones vigentes en el lugar de instalación.

Controles iniciales

1. La tensión y la frecuencia de red deben tener los valores indicados en la chapa de datos del enfriador. La tensión de alimentación no debe salirse en ningún momento de las tolerancias indicadas en el esquema eléctrico, las cuales, salvo indicación diversa, son $\pm 10\%$ para la tensión y $\pm 1\%$ para la frecuencia.
2. La tensión debe ser simétrica (valores eficaces de las tensiones y ángulos de fase entre fases consecutivas iguales entre sí). El desequilibrio máximo admitido entre las tensiones es del 2%.

Conexionado

1. La alimentación eléctrica de los enfriadores se realiza con un cable de cuatro conductores (tres polos más tierra) sin neutro. Para la sección mínima del cable, vea el apartado 7.3.
2. Pasar el cable por el sujetacables situado en el panel posterior del equipo, conectar la fase y el neutro a los bornes del seccionador general (QS) y la tierra al borne correspondiente (PE).
3. Instalar en el origen del cable de alimentación una protección contra contactos directos no inferior a IP2X o IPXXB.
4. En la línea de alimentación eléctrica del enfriador debe haber un interruptor automático con diferencial de (RCCB - IDn = 0.3A), la capacidad máxima indicada en el esquema eléctrico de referencia y un poder de corte adecuado a la corriente de cortocircuito existente en el lugar de instalación. La corriente nominal "In" de dicho magnetotérmico debe ser igual a FLA y la curva de intervención de tipo D.
5. Valor máximo de la impedancia de red = 0,274 ohm.

Controles sucesivos

Comprobar que el equipo y los dispositivos auxiliares estén conectados a tierra y protegidos contra cortocircuitos y sobrecargas.



Una vez conectado el equipo, cuando se cierra el interruptor general de alimentación para energizarlo, la tensión en el circuito eléctrico alcanza valores peligrosos. ¡Se recomienda la máxima precaución!



Es responsabilidad del instalador realizar las pruebas mínimas obligatorias para garantizar una instalación eléctrica correcta según las normativas locales y en coordinación con el sistema correspondiente de conexión a tierra, incluyendo los requisitos específicos para sistemas neutros aislados (IT).

3.4.2 Alarma general

Todos los enfriadores están dotados de indicación de alarma (véase el esquema eléctrico). La regleta tiene un contacto de conmutación libre donde puede conectarse una alarma centralizada exterior de tipo acústico, visual o incluida en un sistema lógico (por ejemplo un PLC).

3.4.3 Encendido y apagado a distancia

Todos los enfriadores pueden dotarse de un mando de arranque y parada a distancia (apartado 7.3).

- Para habilitar el rif remoto. n.16387

- Como variable de referencia ON/OFF rif.n.8996

Nota: no habilitar juntos "Sup" y "Re" .

Para la conexión del contacto ON-OFF a distancia, véase el esquema eléctrico (apartado 7.)

3.5 Versión por agua (W)

Los chillers en versión con condensación por agua, necesitan un circuito hidráulico que conduzca el agua fría al condensador.

El refrigerador por agua posee una válvula presostática, en la entrada del condensador, que sirve para regular el caudal de agua de manera que siempre se obtenga una óptima condensación.

Controles previos

Si la alimentación de agua en el condensador se realiza mediante circuito cerrado, es necesario realizar los controles previos indicados para el circuito hidráulico principal (punto 3.3.1).

Conexión

1. Se recomienda instalar válvulas de interceptación en el circuit de agua de condensación, para desactivar la máquina en caso de mantenimiento.
2. Conectar las tuberías de ida y retorno del agua a los enchufes situados en la parte trasera de la unidad.
3. Si el agua de condensación es desechable, se aconseja instalar en el circuito un filtro en la entrada del condensador para que no se ensucien las superficies.
4. Si el circuito es cerrado, comprobar que esté lleno de agua y sin aire.

4 Control

4.1 Panel de control



Botón ARRIBA: púlselo para incrementar el valor de un parámetro editable seleccionado.

Botón ABAJO: púlselo para reducir el valor de un parámetro editable seleccionado.

Botón ESC: para salir sin guardar; volver al nivel anterior;
PULSADO DURANTE 5 s. RESTABLECER ALARMA.

Botón SET: para salir y guardar/confirmar el valor; ir al siguiente nivel; acceder al menú de ajustes; **PULSADO DURANTE 5 s. ENCENDER EL ENFRIADOR.**

4.2 Significado de los símbolos

Símbolo	Estado del símbolo	función	Símbolo	Estado del símbolo	función	
	Encendido	Compresor ACT		Encendido	Valor de temperatura	
	Destellante	Compresor en espera			Encendido	Valor de presión
	Apagado	Compresor DES				Encendido
	Encendido	Alarma presente		Apagado		Calentador de anticongelante DES
	Destellante	Advertencia o Alarma restablecible				Encendido
Apagado	Sin alarma		Apagado		Calentador del cárter DES Compresor 1	
	Encendido		Bomba 1 ACT			Encendido
	Apagado	Bomba 1 DES	Apagado	Calentador del cárter DES Compresor 2 (no presente)		
	Encendido	Bomba 2 ACT (no presente)		Encendido	Calentador del cárter ACT Compresor 2 (no presente)	
	Apagado	Bomba 2 DES (no presente)		Apagado	Calentador del cárter DES Compresor 2 (no presente)	

4.3 Encendido del enfriador

1. Conecte el suministro eléctrico a la máquina girando el interruptor aislado principal QS a ON.
2. Pulse el botón "set" para encenderla.
3. Ajuste la temperatura de que desee en el controlador. (párr. 4.5.1)

Monitor de fase

Si en la pantalla se visualiza "E-23", el usuario tiene que comprobar que se hayan cableado correctamente los bornes de entrada del interruptor-seccionador.

4.3.1 Ajustes en la puesta en marcha

1. Ajuste de temperatura, consulte el párrafo 4.5.
2. Regulación de la bomba

Verifique el correcto funcionamiento de la bomba con el manómetro (lectura de P1 y P0) y compruebe los valores de límite de presión (Pmáx. y Pmín.) que se indican en la placa de datos de la bomba.

P1 = presión con la bomba en ON
P0 = presión con la bomba en OFF
Pmín. < (P1-P0) < Pmáx.

- Ejemplo n°1.
Condiciones:
circuito cerrado, presión P0 = 2 bar
valores de la placa de datos de la bomba: Pmín. 1 bar/ Pmáx. 3 bar
ajuste la salida de la válvula para dar una presión de 3 bar < P1 < 5 bar

- Ejemplo n°2.
Condiciones:
circuito abierto, presión P0 = 0 bar
valores de la placa de datos de la bomba: Pmín. 1 bar/ Pmáx. 3 bar
ajuste la salida de la válvula para dar una presión de 1 bar < P1 < 3 bar
3. Verifique el correcto funcionamiento de la bomba de manera similar en condiciones de operación normales.
Compruebe también que el amperaje de la bomba esté en los límites indicados en la placa de datos.
4. Apague el enfriador y procesa a llenar el circuito hidráulico a la temperatura de "AJUSTE".
5. Compruebe que la temperatura del agua "tratada" no cae por debajo de 5 °C y que la temperatura ambiente en que funciona el circuito hidráulico no cae por debajo de 5 °C. Si la temperatura es demasiado baja, utilice una cantidad adecuada de glicol, como se explica en el párrafo 3.3.3.

ATENCIÓN! antes de encender la bomba del refrigerador, cierre la válvula de salida del agua (instalada por el cliente).

Mantenga siempre abierta la válvula de entrada (instalada por el cliente).

Al encender la bomba, abra lentamente la válvula de salida del agua del refrigerador y ajuste el caudal como se describe en el punto 4.3.1.

4.3.2 Encendido con agua a alta temperatura

Si la temperatura del circuito de agua es alta (por ejemplo, 30-35 °C), cierre progresivamente (pero no completamente, ¡aproximadamente dos tercios!) la válvula de cierre (disponible en el centro de atención al cliente) en la salida de la enfriadora para reducir el flujo de agua a través de la unidad. Abra gradualmente la válvula tan pronto como la temperatura del agua descienda al valor de funcionamiento.

Importante: En esta condición, pueden activarse varias alarmas de alta presión que deben reiniciarse manualmente.

Importante: Este ajuste también permite evitar golpes de ariete en las tuberías debido a las bolsas de

aire presentes en el circuito (las bolsas de aire deben eliminarse mediante válvulas de purga de aire en los puntos más altos del circuito hidráulico, disponibles en el centro de atención al cliente).

4.4 Parada del enfriador

Cuando no necesite que el enfriador esté en funcionamiento, apáguelo como se indica: Pulse el botón "set" (5 Sec.).

No apague el interruptor QS para que los dispositivos de protección anticongelación sigan recibiendo alimentación eléctrica.

4.5 Parameter settings

General

Hay dos niveles de protección para los parámetros:

- Directo User-(U): con acceso inmediato, **Cambiado por el usuario.**
- Protegido con contraseña Service-(S): se requiere contraseña para acceder, **(no cambiar).**

4.5.1 Parámetros del enfriador (CF9)

PARÁMETRO	CÓDIGO	TIPO	PREDE-TER.
Unidad de medida.	<i>R1</i>	U	<i>OFF</i>
Gestión del relé de alarma	<i>CFJ1</i>	U	<i>0</i>
Restablecer los parámetros predeterminados	<i>dEF</i>	U	<i>OFF</i>
Activación / desactivación remota	<i>R7</i>	U	<i>0</i>
Versión de software	<i>UEr</i>	U	<i>1.70</i>
Dirección de la unidad	<i>CF30</i>	U	<i>1</i>
Velocidad en baudios	<i>CF31</i>	U	<i>3</i>
Protocolo Modbus	<i>CF32</i>	U	<i>1</i>
Activación / desactivación del supervisor	<i>SUP</i>	U	<i>OFF</i>
Activación de punto de ajuste dinámico	<i>Erd</i>	U	<i>OFF</i>

4.5.2 Control de temperatura (ENP)

PARÁMETRO	CÓDIGO	TIPO	PREDE-TER.
Punto de ajuste del control de temperatura (estándar)	<i>SEt</i>	U	<i>13.0</i>
Punto de ajuste del control de temperatura (control de precisión)	<i>SEt</i>	U	<i>20.0</i>
Diferencial de control de la temperatura (NO presente en la configuración "control de precisión")	<i>dIF1</i>	U	<i>4.0</i>

4.5.3 Parámetros de mantenimiento (Mnt)

PARÁMETRO	CÓDIGO	TIPO	PREDE-TER.
Horas de trabajo de la unidad	<i>UH</i>	U	<i>-</i>
Horas de trabajo de la unidad (X1000)	<i>UHL</i>	U	<i>-</i>
Horas de trabajo parciales de la unidad	<i>UPH</i>	U	<i>-</i>
Horas de trabajo parciales de la unidad (X1000)	<i>UPHL</i>	U	<i>-</i>
Horas de trabajo del compresor 1	<i>CH</i>	U	<i>-</i>
Horas de trabajo del compresor 1 (x1000)	<i>CHL</i>	U	<i>-</i>

4.5.4 Parámetros de la sonda (bt1, bt2)

Sonda (bt1)

PARÁMETRO	CÓDIGO	TIPO	PREDE-TER.
Alarma de alta temperatura (agua)	<i>HR1</i>	U	<i>60</i>

Sonda (bt2)

PARÁMETRO	CÓDIGO	TIPO	PREDE-TER.
Alarma de alta temperatura (agua)	<i>HR2</i>	U	<i>60</i>







4.5.5 Historial de alarmas (ALH1)

PARÁMETRO	CÓDIGO	TIPO	PREDE-TER.
Número de alarma	<i>HYSp</i>	U	<i>-</i>
Ver código de alarma	<i>HYSc</i>	U	<i>-</i>
Ver día y mes de la alarma	<i>HYSd</i>	U	<i>-</i>
Ver hora y minutos de la alarma	<i>HYS t</i>	U	<i>-</i>
Temperatura bt1 en el momento de la alarma	<i>HYS1</i>	U	<i>-</i>
Temperatura bt2 en el momento de la alarma	<i>HYS2</i>	U	<i>-</i>
Condiciones de ajuste en el momento de la alarma	<i>HYS3</i>	U	<i>-</i>







4.6 Cambiar parámetros (User)

4.6.1 Parámetros del enfriador "CF9"

Unidad de medida.

Encienda el enfriador "ON" mediante el interruptor seccionador principal QS, y espere en la pantalla la indicación "OFF". Pulse a la vez los botones "esc" "set" para entrar en los parámetros "U".	
Aparece el parámetro "PAr". Pulse el botón "set" para entrar.	
Aparece el parámetro "CF9". Pulse el botón "set" para entrar.	
Aparece el parámetro "A1". Pulse el botón "set" para entrar	
El valor predeterminado es "OFF" = °C Utilice los botones "↵" y "⏶" para seleccionar la unidad de medida. OFF : temperatura = C°, Celsius ; presión = Bar; On : temperatura = °F, Fahrenheit; presión =PSI	
Pulse el botón "set" para confirmar.	
Volver automáticamente a "A1" El parámetro ha sido almacenado. Pulse el botón "esc" tres veces para salir.	

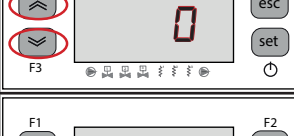
Gestión de alarmas

Encienda el enfriador "ON" mediante el interruptor seccionador principal QS, y espere en la pantalla la indicación "OFF". Pulse a la vez los botones "esc" "set" para entrar en los parámetros "U".	
Aparece el parámetro "PAr". Pulse el botón "set" para entrar.	
Aparece el parámetro "CF9". Pulse el botón "set" para entrar.	
Aparece el parámetro "A1". Utilice los botones "↵" y "⏶" para seleccionar el parámetro "CFJ1".	
Pulse el botón "set" para entrar.	
El valor predeterminado es "0" Utilice los botones "↵" y "⏶" para seleccionar la gestión del relé de alarma (par. 4.5.1- Tab.1)	
Pulse el botón "set" para confirmar.	
Volver automáticamente a "CFJ1" El parámetro ha sido almacenado. Pulse el botón "esc" tres veces para salir.	

Tab.1 Gestión del relé de alarma (CFJ1.)

0	Relé normalmente desactivado, excitado por una alarma.
1	Relé normalmente excitado (también con control OFF), desactivado por una alarma.
2	Relé normalmente excitado (solo con control ON), desactivado por una alarma o con control OFF.

Parámetros predeterminados

<p>Encienda el enfriador "ON" mediante el interruptor seccionador principal QS, y espere en la pantalla la indicación "OFF".</p> <p>Pulse a la vez los botones "esc" y "set" para entrar en los parámetros "U".</p>	
<p>Aparece el parámetro "PAr".</p> <p>Pulse el botón "set" para entrar.</p>	
<p>Aparece el parámetro "CF9".</p> <p>Pulse el botón "set" para entrar.</p>	
<p>Aparece el parámetro "A i".</p> <p>Utilice los botones "set" y "esc" para seleccionar el parámetro "dEF".</p>	
<p>Pulse el botón "set" para entrar.</p>	
<p>El valor predeterminado es "OFF".</p> <p>Utilice los botones "set" y "esc" para pasar de "OFF" a "On".</p>	
<p>Pulse el botón "set" para confirmar.</p>	
<p>Después de unos segundos vuelve a "OFF".</p> <p>Los parámetros se reajustaron automáticamente.</p> <p>Pulse el botón "esc" para uscir, tre volte.</p>	





ON/OFF remoto

<p>Encienda el enfriador "ON" mediante el interruptor seccionador principal QS, y espere en la pantalla la indicación "OFF".</p> <p>Pulse a la vez los botones "esc" y "set" para entrar en los parámetros "U".</p>	
<p>Aparece el parámetro "PAr".</p> <p>Pulse el botón "set" para entrar.</p>	
<p>Aparece el parámetro "CF9".</p> <p>Pulse el botón "set" para entrar.</p>	
<p>Aparece el parámetro "A i".</p> <p>Utilice los botones "set" y "esc" para seleccionar el parámetro "A7".</p>	
<p>Pulse el botón "set" para entrar.</p>	
<p>El valor predeterminado es "0".</p> <p>Utilice los botones "set" y "esc" para seleccionar el modo:</p> <p>(par. 4.5.1- Tab.2)</p>	
<p>Pulse el botón "set" para confirmar.</p>	
<p>Volver automáticamente a "A7".</p> <p>El parámetro ha sido almacenado.</p> <p>Pulse el botón "esc" tres veces para salir.</p>	





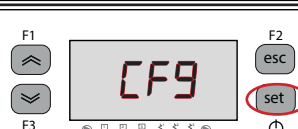
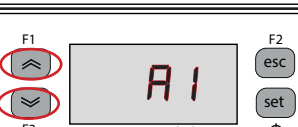
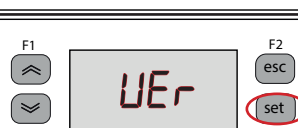
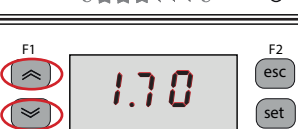

Tab.2 Modo remoto On / Off (A7)

0	On / Off remoto desactivado
1	On/Off remoto junto con On/Off local. En caso de pérdida de alimentación, o si se desconecta el interruptor principal, al recuperar la alimentación eléctrica el enfriador debe reiniciarse de forma local.
2	On/Off remoto solo, On/Off local desactivado

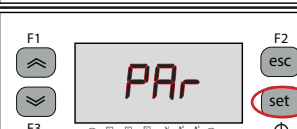
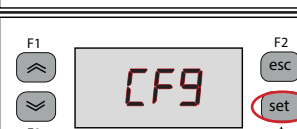
Versión del software (solo lectura)

<p>Encienda el enfriador "ON" mediante el interruptor seccionador principal QS, y espere en la pantalla la indicación "OFF".</p> <p>Pulse a la vez los botones "esc" y "set" para entrar en los parámetros "U".</p>	
<p>Aparece el parámetro "PAR".</p> <p>Pulse el botón "set" para entrar.</p>	
<p>Aparece el parámetro "CF9".</p> <p>Pulse el botón "set" para entrar.</p>	
<p>Aparece el parámetro "A".</p> <p>Utilice los botones "down" y "up" para seleccionar el parámetro "UER".</p>	
<p>Pulse el botón "set" para entrar.</p>	
<p>Se muestra la versión del software</p>	
<p>Pulse el botón "esc" tres veces para salir.</p>	

Habilitación del supervisor

<p>Encienda el enfriador "ON" mediante el interruptor seccionador principal QS, y espere en la pantalla la indicación "OFF".</p> <p>Pulse a la vez los botones "esc" y "set" para entrar en los parámetros "U".</p>	
<p>Aparece el parámetro "PAR".</p> <p>Pulse el botón "set" para entrar.</p>	
<p>Aparece el parámetro "CF9".</p> <p>Pulse el botón "set" para entrar.</p>	
<p>Aparece el parámetro "A".</p> <p>Utilice los botones "down" y "up" para seleccionar el parámetro "SUP".</p>	
<p>Pulse el botón "set" para entrar.</p>	
<p>El valor predeterminado es "OFF".</p> <p>Utilice los botones "down" y "up" para cambiar.</p>	
<p>Pulse el botón "set" para confirmar.</p>	
<p>El parámetro ha sido almacenado.</p> <p>Pulse el botón "esc" tres veces para salir.</p>	

Modbus (dirección)

Encienda el enfriador "ON" mediante el interruptor seccionador principal QS, y espere en la pantalla la indicación "OFF". Pulse a la vez los botones "esc" "set" para entrar en los parámetros "U".	
Aparece el parámetro "PAR". Pulse el botón "set" para entrar.	
Aparece el parámetro "CF9". Pulse el botón "set" para entrar.	
Aparece el parámetro "A1". Utilice los botones "↓" y "↑" para seleccionar el parámetro "CF30".	
Pulse el botón "set" para entrar.	
El valor predeterminado es "1". Utilice los botones "↓" y "↑" para cambiar la dirección.	
Pulse el botón "set" para confirmar.	
El parámetro ha sido almacenado. Pulse el botón "esc" tres veces para salir.	

Modbus (protocolo)

Encienda el enfriador "ON" mediante el interruptor seccionador principal QS, y espere en la pantalla la indicación "OFF". Pulse a la vez los botones "esc" "set" para entrar en los parámetros "U".	
Aparece el parámetro "PAR". Pulse el botón "set" para entrar.	
Aparece el parámetro "CF9". Pulse el botón "set" para entrar.	
Aparece el parámetro "A1". Utilice los botones "↓" y "↑" para seleccionar el parámetro "CF31".	
Pulse el botón "set" para entrar.	
El valor predeterminado es "1". Utilice los botones "↓" y "↑" para cambiar el protocolo. (par. 4.5.1- Tab.3)	
Pulse el botón "set" para confirmar.	
El parámetro ha sido almacenado. Pulse el botón "esc" tres veces para salir.	

Tab.3 Protocolo modbus (opcional) (CF31)

1	PAR	2	NINGUNO	3	IMPAR
---	-----	---	---------	---	-------

Modbus (velocidad en baudios)

<p>Encienda el enfriador "ON" mediante el interruptor seccionador principal QS, y espere en la pantalla la indicación "OFF".</p> <p>Pulse a la vez los botones "esc" y "set" para entrar en los parámetros "U".</p>	
<p>Aparece el parámetro "PAR".</p> <p>Pulse el botón "set" para entrar.</p>	
<p>Aparece el parámetro "CF9".</p> <p>Pulse el botón "set" para entrar.</p>	
<p>Aparece el parámetro "A1".</p> <p>Utilice los botones "↓" y "↑" para seleccionar el parámetro "CF32".</p>	
<p>Pulse el botón "set" para entrar.</p>	
<p>El valor predeterminado es "3".</p> <p>Utilice los botones "↓" y "↑" para modificar la velocidad en baudios. (par. 4.5.1- Tab.4)</p>	
<p>Pulse el botón "set" para confirmar.</p>	
<p>El parámetro ha sido almacenado.</p> <p>Pulse el botón "esc" tres veces para salir.</p>	

Tab.4 Velocidad en baudios (opcional) (CF32)

1	2400	3	9600	5	38400	7	115200
2	4800	4	19200	6	57600		

Nota: si modifica los parámetros de MODBUS, para validar los nuevos parámetros deberá apagar el enfriador y volverlo a encender.

Habilitación de ERD

<p>Encienda el enfriador "ON" mediante el interruptor seccionador principal QS, y espere en la pantalla la indicación "OFF".</p> <p>Pulse a la vez los botones "esc" y "set" para entrar en los parámetros "U".</p>	
<p>Aparece el parámetro "PAR".</p> <p>Pulse el botón "set" para entrar.</p>	
<p>Aparece el parámetro "CF9".</p> <p>Pulse el botón "set" para entrar.</p>	
<p>Aparece el parámetro "A1".</p> <p>Utilice los botones "↓" y "↑" para seleccionar el parámetro "Erd".</p>	
<p>Pulse el botón "set" para entrar.</p>	
<p>El valor predeterminado es "OFF".</p> <p>Utilice los botones "↓" y "↑" para cambiar.</p>	
<p>Pulse el botón "set" para confirmar.</p>	
<p>El parámetro ha sido almacenado.</p> <p>Pulse el botón "esc" tres veces para salir.</p>	

Con el parámetro ERD activado: La temperatura de ajuste del agua cambia en función de la temperatura ambiente. La función solo está activa si el control de precisión de la temperatura está desactivado (CPT=OFF).

4.6.2 Control de temperatura "CNP"

Ajuste del control de temperatura

Encienda el enfriador "ON" mediante el interruptor seccionador principal QS, y espere en la pantalla la indicación "OFF". Pulse a la vez los botones "esc" "set" para entrar en los parámetros "U".	
Aparece el parámetro "PAR". Pulse el botón "set" para entrar.	
Aparece el parámetro "CF9". Utilice los botones "v" y "v" para seleccionar el parámetro "CNP".	
Pulse el botón "set" para entrar.	
Aparece el parámetro "SEt". Pulse el botón "set" para entrar.	
El valor predeterminado es "13.0". Utilice los botones "v" y "v" para modificar el valor.	
Pulse el botón "set" para confirmar.	
El parámetro ha sido almacenado. Pulse el botón "esc" tres veces para salir.	









Importante: Un ajuste de temperatura entre 1 °C y 5 °C, debe ser realizado por técnicos especializados que deben utilizar el manual de servicio específico de este producto.

Regulación de la temperatura diferencial

Encienda el enfriador "ON" mediante el interruptor seccionador principal QS, y espere en la pantalla la indicación "OFF". Pulse a la vez los botones "esc" "set" para entrar en los parámetros "U".	
Aparece el parámetro "PAR". Pulse el botón "set" para entrar.	
Aparece el parámetro "CF9". Utilice los botones "v" y "v" para seleccionar el parámetro "CNP".	
Pulse el botón "set" para entrar.	
Aparece el parámetro "SEt". Utilice los botones "v" y "v" para seleccionar el parámetro "dIF1".	
Pulse el botón "set" para entrar.	
El valor predeterminado es "4.0". Utilice los botones "v" y "v" para modificar el valor.	
Pulse el botón "set" para confirmar.	
El parámetro ha sido almacenado. Pulse el botón "esc" tres veces para salir.	





4.6.3 Parámetro de sonda "bt 1"

Sonda "bt 1".

Encienda el enfriador "ON" mediante el interruptor seccionador principal QS, y espere en la pantalla la indicación "OFF". Pulse a la vez los botones "esc" "set" para entrar en los parámetros "U".	
Aparece el parámetro "PAr". Pulse el botón "set" para entrar.	
Aparece el parámetro "CF9". Utilice los botones "↵" y "⏪" para seleccionar el parámetro "bt1".	
Pulse el botón "set" para entrar.	
Aparece el parámetro "HA 1". Pulse el botón "set" para entrar.	
El valor predeterminado es "60.0". Utilice los botones "↵" y "⏪" para modificar el valor.	
Pulse el botón "set" para confirmar.	
El parámetro ha sido almacenado. Pulse el botón "esc" tres veces para salir.	

Misma secuencia para la sonda "bt2".

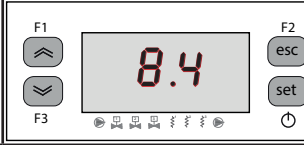
4.7 Visualización sondas/ventilatos/compresor

Enfriador en funcionamiento. Pulse el botón "⏪" para ver las sondas..... <i>bt 1, bt 2, bt 3, bP 1.....</i>	
Seleccione la sonda y espere unos segundos. (Es. BT2)	
Aparece el valor de la sonda <i>bt 2</i> .	
Es aconsejable volver siempre a la sonda <i>bt 1</i>	

Descripción:

- bt 1* : sensor de temperatura de salida de agua
- bt 2* : sensor de temperatura del evaporador
- bt 3* : sensor de temperatura ambiente
- bt 10* : sensor de temperatura del cuadro eléctrico (opción)
- bP 1* : transmisor del circuito 1
- bP 2* : transmisor del circuito 2 (del modelo ICEP080);









F_ _ _ : funcionamiento del ventilador

- F_ _ _ : ventilador apagado
- F- _ _ : ventilador 1 encendidos, ventilador 2 y 3 apagado; (2 = del modelo ICEP022) (3 = del modelo ICEP080)
- F-- _ : ventilador 1 y 2 encendidos, ventilador 3 apagado, (2 = del modelo ICEP022) (3 = del modelo ICEP080)
- F--- : ventiladores 1, 2 y 3 encendidos (del modelo ICEP080)

E ICE : funcionamiento del compresores

- E_ _ _ : compresores desactivados
- E- _ _ : compresores apagados
- E ICE- : compresor 1 encendidos, compresor 2 apagado
- E ICE2 : compresores 1 y 2 encendidos (del modelo ICEP055)
- E ICE- : con " I " Intermitente, compresor 1 listo para usar, compresor 2 apagado

4.8 Ajuste del reloj/calendario

<p>Encienda el enfriador "ON" mediante el interruptor seccionador principal QS, y espere en la pantalla la indicación "OFF".</p> <p>Pulse a la vez los botones "⏪" y "⏩" para entrar en el menú "Datos/Hora".</p>	
<p>Aparece el parámetro "FrEE".</p> <p>Pulse el botón "set" para entrar.</p>	
<p>Aparece el parámetro "A".</p> <p>Utilice los botones "⏪" y "⏩" para seleccionar el parámetro "CL".</p>	
<p>Pulse el botón "set" para entrar.</p>	
<p>Aparece el parámetro "HOUr".</p> <p>Pulse durante 5 segundos el botón "set". Ahora el parámetro destella.</p>	
<p>Utilice los botones "⏪" y "⏩" para seleccionar la fecha, la hora o el año que desee cambiar.</p>	
<p>Pulse el botón "set" para entrar.</p>	
<p>Utilice los botones "⏪" y "⏩" para cambiar el valor (es:año)</p>	
<p>Pulse el botón "set" para confirmar.</p>	

Utilice los botones "⏪" y "⏩" para cambiar otro valor (es:fecha)



Pulse el botón "esc" para salir. El parámetro deja de destellar.



Pulse ambos botones "⏪" y "⏩" para salir.



⚠ La memoria del "reloj / calendario" tiene una duración máxima de tres días, por lo que si el controlador no recibe alimentación eléctrica durante más de tres días, se perderán los datos de hora / mes / año. Ajuste el reloj cuando empiece a utilizar el dispositivo y siempre que sea necesario.

4.9 Gestión de alarmas

En presencia de una alarma, aparecerá el código de alarma y un símbolo en la parte superior izquierda



Continuo = alarma presente

Intermitente = advertencia presente/ Alarma restablecible



Pulse el botón "set" para entrar.



Aparece el parámetro "ALH".

Pulse el botón "F1" para seleccionar el parámetro "AL".



Pulse el botón "set" para entrar.



El código de alarma que aparece es: "Er04".

Pulse el botón "F1" para comprobar si hay más alarmas presentes.

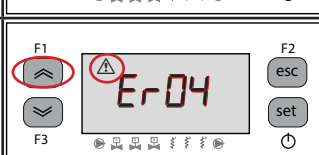

Repare el fallo antes de realizar el reinicio.

Una vez reparado el fallo, el símbolo de alarma comienza a destellar.

Ahora puede realizar el reinicio.





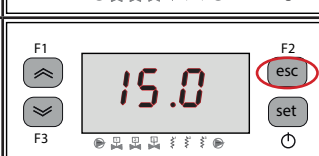

Pulse el botón "esc" hasta que desaparezca la alarma.

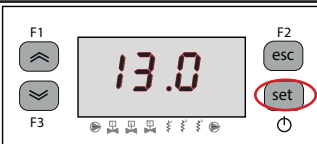

Lista de alarmas/avisos

Código	Descripción	Acción	Restab.
Er01	Sensor bt1 cortado o roto	Alarma	M
Er02	Sensor bt2 cortado o roto	Alarma	M
Er03	Sensor bt3 cortado o roto	Alarma	A
Er05	Sensor bt10 cortado o roto	Alarma	A
Er06	Sensor bP1 cortado o roto	Alarma	M
Er08	Circuito del presostato de alta presión 1	Alarma	M
Er09	Circuito del presostato de baja presión 1	Alarma	M
Er12	Alta temperatura bt1	Alarma	M
Er13	Baja temperatura bt1	Alarma	A
Er14	Alta temperatura bt2	Alarma	M
Er15	Baja temperatura bt2	Alarma	M
Er16	Alta temperatura bt3	Alarma	A
Er17	Baja temperatura bt3	Alarma	A
Er18	Protección térmica del compresor 1	Alarma	M
Er20	Protección térmica de la bomba 1	Alarma	M
Er22	Nivel de agua bajo / Presostato diferencial	Alarma	M
Er23	Monitor de fase	Alarma	M
Er24	Expansión rota o desconectada	Alarma	M
Er25	Horas de trabajo del compresor 1 excedidas	Advertencia	M
Er27	Horas de trabajo de la unidad excedidas	Advertencia	M
Er28	Memoria del reloj	Advertencia	A
Er29	Configuración del enfriador	Advertencia	A

4.10 Historial de alarmas

Enfriador en funcionamiento. Pulse el botón "set" para ver el historial de alarmas.	
Pulse el botón "set" para entrar.	
Utilice los botones "↵" y "⏶" para ver los parámetros. (Par. 4.5.5)	
Pulse el botón "set" para ver el valor.	

5 Mantenimiento

• El equipo ha sido diseñado y realizado para funcionar de manera continua. No obstante, la duración de sus componentes depende directamente del mantenimiento que reciban.

-  Para solicitar asistencia o repuestos, comunique el modelo y el número de serie indicados en la placa de datos que está aplicada en el exterior del equipo. (www.polewr.com)

5.1 Advertencias generales

 Antes de efectuar cualquier operación de mantenimiento, controlar que se haya cortado la alimentación del refrigerador.

 El uso de repuestos no originales exime al fabricante de toda responsabilidad por el mal funcionamiento del equipo.

 En caso de pérdida de refrigerante, llame a un técnico experto y autorizado

 La válvula Schrader debe utilizarse sólo en caso de funcionamiento anómalo del equipo; de lo contrario, los daños causados por una carga incorrecta de refrigerante no serán reconocidos en garantía.

5.2 Refrigerante

Operación de carga: los daños causados por una carga incorrecta realizada por personal no autorizado no serán reconocidos en garantía. 













 El aparato contiene gases fluorados de efecto invernadero.

El fluido refrigerante R513A a temperatura y presión normales, es un gas incoloro perteneciente al SAFETY GROUP A1 - EN378 (fluido del grupo 2 según la directiva PED 2014/68/UE); GWP (Global Warming Potential) = 629.

 En caso de fuga de refrigerante, airee el local.

5.3 Preventive Maintenance Programme

To guarantee lasting maximum chiller efficiency and reliability:

Acciones de mantenimiento	Intervalo de tiempo (condiciones de funcionamiento estándar)			
	Diarias	6 Meses	12 Meses	36 Meses
Acciones comprobar  actuar 				
Comprobar que el indicador POWER ON está encendido.				
Comprobar todos los indicadores del panel de control.				
Limpiar el condensador, rejilla y conexiones.				
Comprobar el consumo eléctrico.				
Comprobar las pérdidas de refrigerante.				
Comprobar y limpiar las Válvula de seguridad de agua (si está presente)*				
Compruebe el sistema eléctrico y el panel eléctrico **				
Comprobar las sondas de temperatura. Sustituir si fuera necesario.				 
Conjunto de mantenimiento				



Están disponibles (apartado 7.):

- kit de servicio: kit eléctrico; kit compresor; kit ventilador; kit evaporador; kit bomba; kit depósito de agua;
- piezas de repuesto individuales.

*Para garantizar la completa eficacia, las válvulas de seguridad se han de verificar periódicamente.
Con el paso del tiempo, las impurezas pueden depositarse cerca de la toma; por consiguiente, es necesario efectuar un lavado periódico del asiento.
Dicho lavado se realiza manualmente, vaciando la válvula girando el mando en el sentido indicado por las flechas.

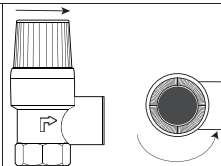

Importante: Tras haber efectuado dicha operación, hay que asegurarse de restablecer la presión de funcionamiento.

****Durante el mantenimiento periódico, el sistema eléctrico de la máquina y el panel eléctrico también se deben revisar según la legislación local. Además, se debería realizar siempre una inspección visual del equipo y los conductores eléctricos en la medida de lo posible, y también se debe revisar el**

apriete correcto de los terminales de los componentes eléctricos, según los pares de apriete especificados en el esquema eléctrico.

5.4 Desguace

El fluido refrigerante y el aceite lubricante contenidos en el circuito deben recogerse de conformidad con las normas locales.

El líquido refrigerante se debe recuperar antes de la destrucción definitiva del equipo ((UE) N° 517/2014 art.8).

	RECICLAJE DESMANTELAMIENTO 
carpintería	acero/resinas epóxicas, poliéster
depósito	aluminio/cobre/acero
tubos/colectores	cobre/aluminio/acero de carbono
aislamiento de los tubos	caucho nitrílico (NBR)
compresor	acero/cobre/aluminio/aceite
condensador	acero/cobre/aluminio
bomba	acero/fundición/latón
ventilador	aluminio
refrigerante	R513A
válvulas	latón/cobre
cables eléctricos	cobre/PVC

Los equipos que contengan componentes eléctricos deben eliminarse por separado junto con los residuos eléctricos y electrónicos de acuerdo con la legislación local y vigente.



6 Solución de problemas

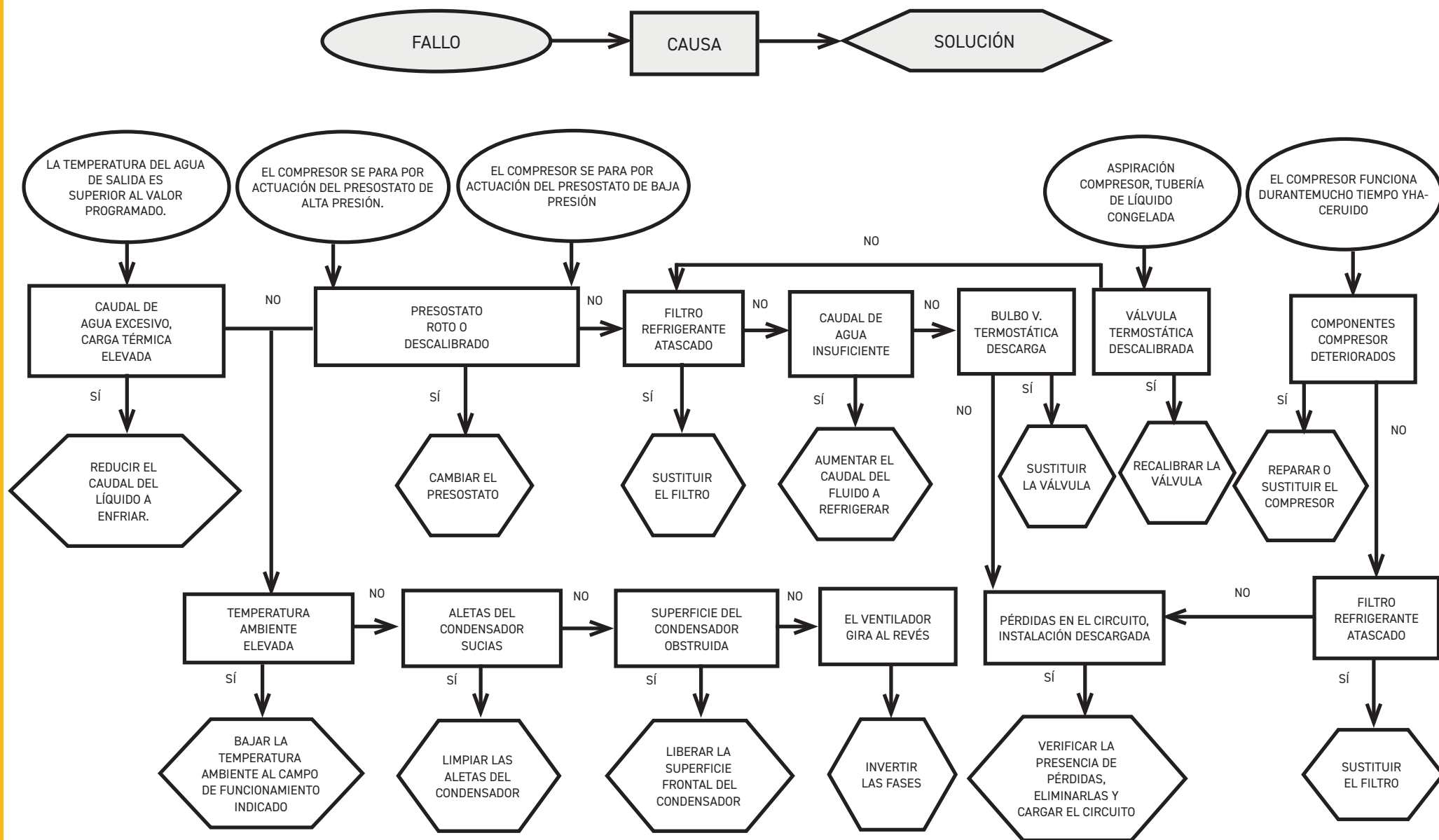

1 Sécurité	2
1.1 Importance de la notice.....	2
1.2 Signaux d'avertissement	2
1.3 Consignes de sécurité	2
1.4 Risques résiduels.....	2
2 Introduction	3
2.1 Transport	3
2.2 Manutention	3
2.3 Inspection ou visite.....	3
2.4 Stockage.....	3
3 Installation	3
3.1 Espace de travail.....	3
3.2 Versions.....	3
3.3 Circuit hydraulique	3
3.3.1 Contrôles et raccordement.....	3
3.3.2 Eau et glycol éthylénique	4
3.3.3 Vase d'expansion.....	4
3.4 Circuit électrique.....	5
3.4.1 Contrôles et branchements	5
3.4.2 Alarme générale.....	5
3.4.3 ON/OFF à distance	5
3.5 Version condensation à eau (W).....	5
4 Commande	6
4.1 Tableau de commande.....	6
4.2 Signification des symboles.....	6
4.3 Démarrage du refroidisseur	6
4.3.1 Réglages à la mise en service	6
4.3.2 Démarrage avec eau à haute température.....	6
4.4 Arrêt du refroidisseur.....	7
4.5 Réglages des paramètres.....	7
4.5.1 Paramètres du refroidisseur (CF9)	7
4.5.2 Contrôle de la température (CNP).....	7
4.5.3 Paramètres de maintenance (Pnt).....	7
4.5.4 Paramètres de la sonde (bE 1, bE 2).....	7
4.5.5 Historique des alarmes (RLH 1).....	7
4.6 Modification des paramètres (User).....	8
4.6.1 Paramètres du refroidisseur (CF9)	8
4.6.2 Contrôle de la température « CNP »	13
4.6.3 Paramètre sonde « bE 1 ».....	14
4.7 Visualisation sondes/ ventilateur/ compresseur.....	14
4.8 Réglage de l'heure/ la date.....	15
4.9 Gestion des alarmes.....	16
4.10 Historique des alarmes.....	17
5 Entretien	17
5.1 Recommandations générales.....	17
5.2 Réfrigérant	17
5.3 Entretien préventif ou prédictif.....	18
5.4 Mise au rebut.....	18

7 Appendix

7.1 Légende
7.2 Schéma d'installation
7.3 Manipulation - espace de travail
7.4 Caractéristiques techniques
7.5 Dimensions
7.6 Liste des pièces de rechange
7.7 Dessins éclatés
7.8 Schéma du circuit
7.9 Schéma électrique

1 Sécurité

1.1 Importance de la notice

- La notice doit être conservée pendant toute la durée de vie de la machine.
- Lire la notice avant toute opération ou intervention.
- La notice est sujette à modifications : pour une information actualisée, consulter la version à bord de la machine.

1.2 Signaux d'avertissement



Instructions pour éviter de faire courir des risques aux personnes.



Instructions à suivre pour éviter de faire subir des dégâts à l'appareil.





La présence d'un professionnel qualifié et agréé est exigée.



Sont présents des symboles dont la signification est donnée au paragraphe 7.

1.3 Consignes de sécurité

 Chaque unité est munie d'un sectionneur électrique pour permettre toute intervention en conditions de sécurité. Toujours actionner ce dispositif pour éliminer les risques pendant les opérations d'entretien.

 La notice s'adresse à l'utilisateur final uniquement pour les opérations pouvant être effectuées panneaux fermés ; par contre, les opérations de installation/la mise en service/entretien o qui nécessitent l'ouverture avec des outils doivent être confiées à un professionnel expert et qualifié.

 Pour installation uniquement dans des endroits non accessibles au grand public, soit dans un endroit sécurisé avec accès restreint, soit à un niveau non inférieur à 2,5 m, soit dans des zones de toit sécurisées, à moins qu'ils ne bénéficient d'une surveillance ou d'instructions concernant l'utilisation de l'appareil par une personne responsable de leur sécurité.

 La distance d'installation par rapport au mur et l'espace de fonctionnement libre sont indiqués sur le par.7.3.

 Attention : respecter les températures et pressions minimales/maximales indiquées au paragraphe 7.4, ainsi que la plage de température de fonctionnement globale indiquée au paragraphe 7.2.

 Toutes les unités peuvent être installées à l'extérieur.

 Tous les branchements électriques doivent être conformes aux prescriptions locales du lieu

d'installation.

 Ne pas dépasser les limites définies par le projet, qui sont indiquées sur la plaque des caractéristiques.

 Il incombe à l'utilisateur d'éviter des charges différentes de la pression statique interne. En cas de risque d'activité sismique, l'unité doit être convenablement protégée. N'utiliser l'unité que pour un usage professionnel et pour la destination prévue par le constructeur.

 Il incombe à l'utilisateur d'analyser tous les aspects de l'application pour laquelle l'unité est installée, de suivre toutes les consignes industrielles de sécurité applicables et toutes les prescriptions inhérentes au produit contenues dans le manuel d'utilisation et dans tout autre documentation réalisée et fournie avec l'unité.

La modification ou l'adaptation ou le remplacement d'un composant quelconque par une personne non autorisée et/ou l'usage impropre de l'unité dégage le constructeur de toute responsabilité et comportent l'annulation de la garantie.

Le constructeur ne saurait être tenu pour responsable pour tous les dommages matériels aux choses ou à l'unité et pour tous les dommages physiques aux personnes dérivant d'une négligence des opérateurs, du non-respect de toutes les instructions de la présente notice, de l'inapplication des normes en vigueur concernant la sécurité de l'installation.

La responsabilité du constructeur est dérogée pour tous les dommages ou dégâts éventuels pouvant résulter de manipulations malveillantes et/ou de modifications de l'emballage.

L'utilisateur doit s'assurer que les conditions fournies pour la sélection de l'unité ou de ses composants et/ou options sont parfaitement conformes pour une utilisation correcte de cette même unité ou de ses composants.

 **ATTENTION: Le fabricant se réserve le droit de modifier sans aucun préavis les informations contenues dans ce manuel. Afin de disposer d'informations complètes et actualisées, il est recommandé à l'utilisateur de consulter le fabricant.**

1.4 Risques résiduels

L'installation, la mise en marche, l'arrêt et l'entretien de la machine doivent être effectués conformément aux dispositions prévues par la documentation technique du produit et, quoiqu'il en soit, de manière à ne créer aucune situation de risque.

Les risques n'ayant pu être éliminés en phase de conception sont indiqués dans le tableau suivant.

partie concernée	risque résiduel	modalité	précautions
batterie d'échange thermique	petites coupures	contact	éviter tout contact, porter des gants de protection
grille ventilateur et ventilateur	lésions	introduction d'objets pointus à travers la grille lors du fonctionnement du ventilateur	n'introduire aucune sorte d'objets dans la grille des ventilateurs et ne poser aucun objet sur les grilles
partie interne de l'unité : compresseur et tuyau de refoulement	brûlures	contact	éviter tout contact, porter des gants de protection

partie concernée	risque résiduel	modalité	précautions
partie interne de l'unité : parties métalliques et câbles électriques	intoxications, électrocution, brûlures graves	défaut d'isolation des câbles d'alimentation en amont du tableau électrique de l'unité, parties métalliques sous tension	protection électrique appropriée de la ligne d'alimentation ; faire très attention lors de la connexion à la terre des parties métalliques
partie externe de l'unité : zone environnante de l'unité	intoxications, brûlures graves	incendie dû à un court-circuit ou une surchauffe de la ligne d'alimentation en amont du tableau électrique de l'unité	section des câbles et système de protection de la ligne d'alimentation électrique conformes aux normes en vigueur

2 Introduction

Les moteurs du compresseur, de la pompe et du ventilateur sont protégés contre d'éventuelles surchauffes.

2.1 Transport

L'unité emballée doit rester

- en position verticale ;
- à l'abri des intempéries ;
- à l'abri des chocs.

2.2 Manutention

Utiliser un chariot élévateur d'une capacité suffisante à soulever le poids de la machine. Éviter tous chocs pendant la manutention.

2.3 Inspection ou visite

- Toutes les unités sont assemblées, câblées, chargées de réfrigérant et d'huile et testées en usine ;
- après réception de la machine, l'examiner soigneusement pour vérifier son état : recourir contre le transporteur pour les dommages éventuellement survenus au cours du transport ;
- débaler l'unité le plus près possible de son lieu d'implantation.

2.4 Stockage

- Conserver l'unité dans son emballage en un lieu propre et à l'abri de l'humidité et des intempéries.
- ne pas superposer les unités ;
- suivre les instructions sur l'emballage.

3 Installation

 Pour une installation optimale, suivre scrupuleusement les indications des paragraphes 7.

 Le produit installé doit être convenablement protégé contre les risques d'incendie (réf. EN378-3).

 **Il est recommandé d'équiper tous les refroidisseurs de systèmes de pré-filtrage à proximité de l'entrée d'eau des refroidisseurs (degré de filtrage : min.05mm; max1.0mm).**

 **Liquides à refroidir**

Les liquides à refroidir doivent être compatibles avec les matériaux utilisés.

Exemples de liquides utilisés: de l'eau **ou des mélanges d'eau et de glycole éthylène ou propylène.**

Les liquides à refroidir ne doivent pas être inflammables.

Si les liquides à refroidir contiennent des substances dangereuses (glycol de la série éthylénique/propylénique, par exemple), toute fuite éventuelle doit être recueillie dans un récipient approprié, car potentiellement nuisible à l'environnement. En cas de vidange du circuit hydraulique, respecter la loi antipollution qui interdit le rejet des huiles usagées à l'égout ou dans la nature.

3.1 Espace de travail

 **Prévoir un espace de dégagement de 1,5 m autour de l'unité.**

Laisser au moins 2 mètres d'espace au-dessus de la centrale sur les modèles à expulsion verticale de l'air de condensation.

3.2 Versions

Version à air: Ventilateurs axiaux (A)

Ne pas créer des situations de recyclage de l'air de refroidissement.

Ne pas obstruer les grilles de ventilation.

Pour les versions avec ventilateurs axiaux, il est déconseillé de canaliser l'air épuisé.

Version à eau (W)

Si l'eau au condenseur est en circuit ouvert, installer le filtre à crépine sur l'arrivée d'eau de condensation.

Pour des eaux de refroidissement spéciales (déionisée, déminéralisée, distillée) les matériaux standard prévus pour le condenseur pourraient ne pas être appropriés. Dans ce cas, veuillez contacter le constructeur.

3.3 Circuit hydraulique

3.3.1 Contrôles et raccordement

 Avant de raccorder le refroidisseur et de remplir le circuit, s'assurer que les tuyaux sont propres. Dans le cas contraire, laver soigneusement.

  **Si le circuit hydraulique est de type fermé, sous pression, une soupape de sécurité réglée à : 6 bar.**

 Il est conseillé de toujours installer des filtres grillagés sur les tuyauteries d'entrée et de sortie de l'eau.

 Si le circuit hydraulique est intercepté par des soupapes automatiques, protéger la pompe avec des systèmes contre les coups de bélier.

 Si le circuit est vidé pour inutilisation prolongée, ajouter du fluide lubrifiant sur le rotor de la pompe pour éviter le blocage au démarrage suivant. En cas de blocage du rotor débloquent manuellement.

Déposer le couvercle arrière de la pompe et tourner délicatement le ventilateur en plastique. Si l'arbre est encore bloqué, déposer le ventilateur et actionner directement l'arbre. Une fois le rotor débloquent, remettre en place le ventilateur et le couvercle.

Contrôles préliminaires

1. Contrôler que les éventuels robinets d'arrêt du circuit hydraulique sont ouverts.
2. Si le circuit hydraulique est de type fermé, contrôler que la capacité du vase d'expansion installé est adéquate.

Raccordement

1. Raccorder le réfrigérateur d'eau aux tuyaux d'arrivée et de sortie, en utilisant les raccords positionnés dans la partie postérieure de l'unité.
Il est conseillé d'utiliser des joints flexibles pour éliminer la rigidité du système.
2. Remplir le circuit hydraulique en utilisant le raccord de charge spécifique positionné à l'arrière du refroidisseur () .
3. Le réservoir est doté d'une soupape de décharge à actionner manuellement lors du remplissage. A ce propos, si le circuit hydraulique présente des points à une hauteur supérieure, installer une soupape d'évent à ces endroits.
4. Il est conseillé de doter les tuyauteries d'entrée et de sortie d'un robinet, de manière à pouvoir exclure la machine du circuit en cas d'entretien nécessaire.
5. Si le refroidisseur fonctionne avec la cuve ouverte, la pompe doit être installée en aspiration à la cuve et en refoulement au refroidisseur.

 **Attention (modèles 022-120): la machine est équipée d'un dispositif de protection automatique pour le réservoir.**

Si l'entrée d'eau est fermée par inadvertance lorsque la pompe fonctionne et que la sortie d'eau est ouverte, de l'air pénétrera dans le réservoir avec l'intervention probable du capteur de niveau. Il sera nécessaire de purger le circuit hydraulique pour éliminer l'air.

Contrôles successifs

1. Contrôler que tout l'air a bien été évacué du réservoir et du circuit et que ces derniers sont pleins d'eau.
2. Le circuit hydraulique doit être toujours rempli. Pour ce faire, il est possible de contrôler et de remettre à niveau périodiquement ou bien de doter l'installation d'un kit de remplissage automatique.

Caractéristiques de l'eau

Si la fourniture ne le prévoit pas, monter une crépine sur l'entrée de l'eau.

  Caractéristiques de l'eau:

Température	≥50°F (10°C)	CL ⁻	<50 ppm
ΔT IN/OUT	5-15°C	CaCO ₃	70-150 ppm
Max % glycole	50	O ₂	<0.1 ppm
Pression	43.5-145 PSig (3-10 barg)	Fe	<0.2 ppm
PH	7.5-9	NO ₃	<2 ppm

Conductivité électrique	10-500 μS/cm	HCO ₃ ⁻	70-300 ppm
Indice de saturation de Langelier	0-1	H ₂ S	<0.05 ppm
SO ₄ ²⁻	<50 ppm	CO ₂	<5 ppm
NH ₃	<1 ppm	Al	<0.2 ppm

Pour des eaux spéciales (déionisée, déminéralisée, distillée) les matériaux standard prévus pour le réfrigérateur d'eau pourraient ne pas être appropriés. Dans ce cas, veuillez contacter le constructeur.

3.3.2 Eau et glycol éthylénique

Si l'unité est installée en plein air ou, quoiqu'il en soit, dans un endroit fermé non chauffé, il se peut qu'au cours de ses périodes d'inactivité, correspondant aux moments les plus froids de l'année, l'eau du circuit gèle

Pour réduire ce risque :

- de doter le refroidisseur de protections antigèle adéquates fournies en option par le constructeur ;
- de vidanger l'installation au moyen de la soupape de décharge en cas d'arrêts prolongés ;
- d'ajouter une quantité adéquate d'antigel à l'eau de circulation (voir tableau).

Température de l'eau en sortie [°C]	Glycol éthylénique (% vol.)	Température ambiante
4	5	-2
2	10	-5
0	15	-7
-2	20	-10
-4	25	-12
-6	30	-15
-10	40	-20

3.3.3 Vase d'expansion

Pour éviter que les augmentations ou les diminutions de volume du fluide, dues à une variation sensible de sa température, n'endommagent la machine ou le circuit, il est conseillé d'installer un vase d'expansion d'une capacité adéquate.

Le vase d'expansion doit être installé en aspiration sur la pompe sur le raccord postérieur du réservoir.

Pour calculer le volume minimal du vase d'expansion à appliquer à un circuit fermé, il est possible d'utiliser la formule suivante :

$$V=2 \times V_{tot} \times (P_{t \min} - P_{t \max})$$

où

V_{tot}= vol. total du circuit (en litres)

P_{t min/max}= poids spécifique à la température minimale/maximale que l'eau peut atteindre [kg/dm³].

Les valeurs de poids spécifique en fonction de la température et du pourcentage de glycol sont indiquées dans le tableau suivant:

% glycol	Température [°C]						
	-10	0	10	20	30	40	50
0%	1.0024	1.0008	0.9988	0.9964	0.9936	0.9905	0.9869
10%	1.0177	1.0155	1.0130	1.0101	1.0067	1.0030	0.9989
20%	1.0330	1.0303	1.0272	1.0237	1.0199	1.0156	1.0110
30%	1.0483	1.0450	1.0414	1.0374	1.0330	1.0282	1.0230

40%	1.0636	1.0594	1.0525	1.0511	1.0461	1.0408	1.0350
-----	--------	--------	--------	--------	--------	--------	--------

 **Attention : pendant le remplissage, se référer aux données de chargement pour le vase d'expansion.**

Si la température de l'air ambiant au niveau du refroidisseur est inférieure à -10 °C, vous devez déplacer le vase d'expansion vers une enceinte protégée du côté retour d'eau du refroidisseur. La soupape de sécurité et la soupape de purge doivent rester sur le refroidisseur.

3.4 Circuit électrique

3.4.1 Contrôles et branchements

 Avant d'effectuer toute opération sur des parties électriques, s'assurer qu'elles ne sont pas sous tension.

Tous les branchements électriques doivent être conformes aux prescriptions locales du lieu d'installation.

Contrôles initiaux

1. La tension et la fréquence de réseau doivent correspondre aux valeurs estampillées sur la plaquette des données du refroidisseur. La tension d'alimentation ne doit pas, ne serait-ce que pour de courts instants, dépasser les limites de tolérance indiquées sur le schéma électrique qui, sous réserve d'indications différentes, équivalent à +/- 10% pour la tension et à +/- 1% pour la fréquence.
2. La tension doit être symétrique (valeurs efficaces des tensions et des angles de phase entre phases consécutives égales). Le déséquilibre maximal admis entre les tensions est de 2%.

Raccordement

1. L'alimentation électrique des refroidisseurs est effectuée au moyen d'un câble à 3 fils, 2 pôles+terre. Pour la section minimale du câble, voir paragraphe 7.
2. Passer le câble à travers le serre-câble situé sur le panneau postérieur de la machine et connecter la phase et le neutre aux bornes du sectionneur général (QS), la terre doit être connectée à la borne de terre prévue à cet effet (PE).
3. Assurer au commencement du câble d'alimentation une protection contre les contacts directs équivalant à au moins IP2Xo IPXXB.
4. Installer, sur la ligne d'alimentation électrique du refroidisseur, un interrupteur automatique avec différentiel (RCCB - IDn = 0.3A), de la portée maximale indiquée sur le schéma électrique de référence, avec un pouvoir d'interruption approprié au courant de court-circuit existant dans la zone d'installation de la machine.
Le courant nominal «In» de ce disjoncteur magnéto-thermique doit être égal à FLA et la courbe de déclenchement de type D.
5. Valeur maximum de l'impédance du réseau = 0.274 ohm.

Contrôles successifs

S'assurer que la machine et les équipements auxiliaires sont bien mis à la terre et qu'ils sont protégés contre les courts-circuits et/ou les surcharges.

 **Après avoir branché l'unité et fermé l'interrupteur général en amont (mettant ainsi la machine sous tension), le voltage atteint dans le circuit électrique des valeurs dangereuses. Faire très attention !.**

 **Il incombe à l'installateur d'effectuer les tests minimums obligatoires pour assurer une installation électrique correcte conformément aux réglementations locales et en coordination avec le système de mise à la terre pertinent, y compris les exigences spécifiques pour les systèmes à neutre**

isolé (IT).

3.4.2 Alarme générale

Tous les refroidisseurs sont dotés d'un dispositif de signalisation d'alarme de la machine (voir le schéma électrique), composé d'un contact libre inverseur indiqué sur la boîte à bornes, ce qui permet de connecter une alarme centralisée externe, sonore, visuelle ou introduite dans des logiques, PLC par exemple.

3.4.3 ON/OFF à distance

Tous les refroidisseurs peuvent être dotés d'une commande de mise en marche et d'arrêt à distance (voir paragraphe 7.).

- Pour activer le rif à distance. n.16387

- Comme variable de référence ON/OFF rif.n.8996

Remarque : n'activez pas ensemble « Sup » et « Re ».

Pour le raccordement du contact ON-OFF à distance voir le schéma électrique (voir paragraphe 7.)

3.5 Version condensation à eau (W)

Les unités de production d'eau glacée version avec condensation à eau nécessitent un circuit hydraulique qui dirige l'eau froide vers le condenseur.

La centrale en version à eau est dotée d'une soupape pressostatique en entrée de condenseur dont la fonction est de régler le débit d'eau de façon à obtenir toujours une condensation optimale.

Contrôles préliminaires

Si l'alimentation d'eau au condenseur est réalisée en circuit fermé, il faudra effectuer tous les contrôles préliminaires prévus pour le circuit hydraulique principal (paragraphe 3.3.1).

Raccordement

1. Il est conseillé de prévoir sur le circuit d'eau de condensation des vannes d'arrêt, de manière à pouvoir exclure le fonctionnement de l'appareil lors des travaux d'entretien.
2. Brancher les tuyauteries de départ/retour eausur les raccords prévus à cet effet, placés au dos de l'unité.
3. Si l'eau de condensation doit être évacuée, il faudra prévoir de doter le circuit d'un filtre sur l'entrée du condenseur, de façon à limiter le risque d'encrassement des surfaces.
4. Si le circuit est de type fermé, vérifier qu'il soit bien rempli et correctement purgé (de l'air).

4 Commande

4.1 Tableau de commande



Touche flèche vers le haut : appuyer pour augmenter la valeur du paramètre modifiable sélectionné.



Touche flèche vers le bas : appuyer pour diminuer la valeur du paramètre modifiable sélectionné.



Touche ESC : pour quitter sans enregistrer ; revenir au niveau précédent.

EN APPUYANT PENDANT 5s. ON RÉINITIALISE L'ALARME.



Touche SET : pour quitter et enregistrer / confirmer la valeur ; passer au niveau suivant ; ouvrir le menu Réglage. **EN APPUYANT PENDANT 5s ON DÉMARRE LE REFROIDISSEUR.**

4.2 Signification des symboles

Symbole	État du symbole	Fonction	Symbole	État du symbole	Fonction	
	Allumé	Compresseur en marche		Allumé	Valeur de la température	
	Clignotant	Compresseur en veille			Allumé	Valeur de la pression
	Éteint	Compresseur à l'arrêt				
	Allumé	Alarme en cours		Allumé	Chauffage antigel en marche	
	Clignotant	Avertissement ou Alarme réinitialisable			Éteint	Chauffage antigel coupé
	Éteint	Pas d'alarme				
	Allumé	Pompe 1 en marche		Allumé	Chauffage du carter en marche Compresseur 1	
	Éteint	Pompe 1 à l'arrêt		Éteint	Chauffage du carter coupé Compresseur 1	
	Allumé	Pompe 2 en marche (absent)		Allumé	Chauffage du carter en marche Compresseur 2 (absent)	
	Éteint	Pompe 2 à l'arrêt (absent)		Éteint	Chauffage du carter coupé Compresseur 2 (absent)	

4.3 Démarrage du refroidisseur

1. Brancher l'alimentation de la machine en tournant le sélecteur de l'isolateur principal QS sur ON.
2. Appuyer sur le bouton "set" pour démarrer.
3. Régler la température voulue sur le contrôleur. (parag. 4.5.1)

Moniteur de phase

Si au l'afficheur indique l'alarme «Er 23», l'utilisateur doit vérifier avoir effectué correctement le câblage des bornes en entrée de l'interrupteur sectionneur.

4.3.1 Réglages à la mise en service

1. Réglage de la température, voir le paragraphe 4.5.
2. Réglage de la pompe (uniquement pour version à eau)
Vérifier que la pompe fonctionne correctement à l'aide de la jauge de pression (lire P1 et P0) et en vérifiant les valeurs limite de la pression (Pmax et Pmin) indiquées sur la plaquette des données de la pompe.

P1 = pression à pompe ALLUMÉE

P0 = pression à pompe ÉTEINTE

$P_{min} < (P1 - P0) < P_{max}$

- Exemple n°1.

Conditions :

circuit fermé, pression P0 = 2 bar

valeurs de la plaquette des données de la pompe : Pmin 1 bar/ Pmax 3 bar

régler la sortie de la vanne afin d'obtenir une pression de 3 bar < P1 < 5 bar

- Exemple n°2.

Conditions :

circuit ouvert, pression P0 = 0 bar

valeurs de la plaquette des données de la pompe : Pmin 1 bar/ Pmax 3 bar

régler la sortie de la vanne afin d'obtenir une pression de 1 bar < P1 < 3 bar

3. Vérifier le bon fonctionnement de la pompe en conditions de travail normales.
Vérifier également que l'ampérage de la pompe est compris dans les limites indiquées sur la plaquette des données.
4. Éteindre le refroidisseur et procéder au remplissage d'appoint du circuit hydraulique à la température paramétrée « SET ».
5. Vérifier que la température de l'eau « traitée » ne descend pas sous 5°C et que la température ambiante dans laquelle le circuit hydraulique fonctionne ne descend pas sous 5°C. Si la température est trop basse, ajouter la quantité nécessaire de glycol en suivant les indications fournies au paragraphe 3.3.3

ATTENTION ! : avant de mettre la pompe du chiller en marche, fermez la vanne de sortie d'eau (à installer par le client).

Maintenez toujours la vanne d'admission (à installer par le client) ouverte.

Pour mettre la pompe en marche, ouvrez lentement la vanne de sortie d'eau du chiller et réglez le débit comme décrit au point 4.3.1.

4.3.2 Démarrage avec eau à haute température

Si la température de l'eau du circuit est élevée (par exemple, 30-35 °C), fermez progressivement (mais pas complètement, environ aux deux tiers !) la vanne d'arrêt (à la charge du client) à la sortie du refroidisseur afin de réduire le débit d'eau dans l'unité. Ouvrez progressivement la vanne dès que la température de l'eau redescend à la valeur de fonctionnement.

Important : dans ces conditions, plusieurs alarmes de haute pression peuvent se déclencher et doi-

vent être réinitialisées manuellement.

Important : ce réglage permet également d'éviter les coups de bélier dans les canalisations dus aux poches d'air présentes dans le circuit (ces poches d'air doivent être éliminées par des purgeurs d'air installés aux points les plus élevés du circuit hydraulique, à la charge du client).

4.4 Arrêt du refroidisseur

Lorsque le refroidisseur n'est plus nécessaire, l'éteindre comme suit : Appuyer sur le bouton "set" (5 sec.).

Ne pas éteindre le sélecteur principal QS, afin de permettre aux dispositifs de protection antigel d'être alimentés.

4.5 Réglages des paramètres

Généralités

Il existe deux niveaux de protection pour les paramètres :

- a) Direct User-(U) : à accès immédiat, **Modifiable par l'utilisateur** ;
- b) Protégé par mot de passe Service-(S) : un mot de passe est requis pour y accéder (**ne pas les modifier**).

4.5.1 Paramètres du refroidisseur (CF9)

PARAMÈTRE	CODE	TYPE	PAR DÉFAUT
Unité de mesure.	R1	U	OFF
Gestion du relais d'alarme	CFJ1	U	0
Rétablir les paramètres par défaut	dEF	U	OFF
Mode distant On/Off	R7	U	0
Version du logiciel	UEr	U	1.7.0
Adresse de l'unité	CF30	U	1
Vitesse de transmission (bauds)	CF31	U	5
Protocole Modbus	CF32	U	1
Mode superviseur On/Off	SUP	U	OFF
Activation point de consigne dynamique	ErD	U	OFF

4.5.2 Contrôle de la température (CNP)

PARAMÈTRE	CODE	TYPE	PAR DÉFAUT
Point de consigne du contrôle de température (standard)	SEt	U	13.0
Point de consigne du contrôle de température (contrôle de précision)	SEt	U	20.0
Différentiel de contrôle de la température (NON présent dans la configuration « contrôle de précision »)	dIF1	U	4.0

4.5.3 Paramètres de maintenance (Mnt)

PARAMÈTRE	CODE	TYPE	PAR DÉFAUT
Heures de service	UH	U	-
Heures de service (X1000)	UHL	U	-
Heures de service partielles	UPH	U	-
Heures de service partielles (X1000)	UPHL	U	-
Heures de service du compresseur 1	CIH	U	-
Heures de service du compresseur 1 (x1000)	CIHL	U	-

4.5.4 Paramètres de la sonde (bt1, bt2)

Sonde (bt1)

PARAMÈTRE	CODE	TYPE	PAR DÉFAUT
Alarme haute température (eau)	HR1	U	60

Sonde (bt2)

PARAMÈTRE	CODE	TYPE	PAR DÉFAUT
Alarme haute température (eau)	HR2	U	60

4.5.5 Historique des alarmes (ALH1)

PARAMÈTRE	CODE	TYPE	PAR DÉFAUT
Numéro d'alarme	HYSp	U	-
Voir le code d'alarme	HYSc	U	-
Afficher le jour et le mois de déclenchement de l'alarme	HYSd	U	-
Voir l'heure et les minutes de déclenchement de l'alarme	HYSé	U	-
Température bt1 au moment du déclenchement de l'alarme	HYS1	U	-
Température bt2 au moment du déclenchement de l'alarme	HYS2	U	-
Conditions de CONSIGNE au moment du déclenchement de l'alarme	HYS3	U	-

4.6 Modification des paramètres (User)

4.6.1 Paramètres du refroidisseur (CF9)

Unité de mesure.

Allumer le refroidisseur « ON » au moyen de l'interrupteur principal QS et attendre que « OFF » apparaisse sur l'écran. Appuyer simultanément sur les touches « esc » « set » pour entrer dans le type de paramètre « U ».	
Le paramètre « PAr » s'affiche. Appuyer sur la touche « set » pour entrer.	
Le paramètre « CF9 » s'affiche. Appuyer sur la touche « set » pour entrer.	
Le paramètre « A1 » s'affiche. Appuyer sur la touche « set » pour entrer.	
La valeur par défaut est « OFF » = °C Utiliser les touches « ⇩ » et « ⇧ » pour sélectionner l'unité de mesure. OFF : température = °C, Celsius ; pression = Bar; On : température = °F, Fahrenheit ; pression = PSI	
Appuyer sur la touche « set » pour confirmer.	
Retour automatique à « A1 » Le paramètre a été enregistré. Appuyer trois fois sur la touche « esc » pour quitter.	

Gestion des alarmes

Allumer le refroidisseur « ON » au moyen de l'interrupteur principal QS et attendre que « OFF » apparaisse sur l'écran. Appuyer simultanément sur les touches « esc » « set » pour entrer dans le type de paramètre « U ».	
Le paramètre « PAr » s'affiche. Appuyer sur la touche « set » pour entrer.	
Le paramètre « CF9 » s'affiche. Appuyer sur la touche « set » pour entrer.	
Le paramètre « A1 » s'affiche. Utiliser les touches « ⇩ » et « ⇧ » pour sélectionner le paramètre « CFJ1 ».	
Appuyer sur la touche « set » pour entrer.	
La valeur par défaut est « 0 » Utiliser les touches « ⇩ » et « ⇧ » pour sélectionner la gestion du relais d'alarme (§ 4.5.1- Tab.1)	
Appuyer sur la touche « set » pour confirmer.	
Retour automatique à « CFJ1 » Le paramètre a été enregistré. Appuyer trois fois sur la touche « esc » pour quitter.	

Tab.1 Gestion du relais d'alarme (CFJ1.)

0	Relais normalement désactivé, excité par une alarme.
1	Relais normalement excité (même lorsque la commande est OFF) désactivé par une alarme.
2	Relais normalement excité (uniquement si le contrôle est ON), désactivé par une alarme ou la commande OFF.

Paramètres par défaut

<p>Allumer le refroidisseur « ON » au moyen de l'interrupteur principal QS et attendre que « OFF » apparaisse sur l'écran.</p> <p>Appuyer simultanément sur les touches « esc » « set » pour entrer dans le type de paramètre « U ».</p>	
<p>Le paramètre « PAr » s'affiche.</p> <p>Appuyer sur la touche « set » pour entrer.</p>	
<p>Le paramètre « CF9 » s'affiche.</p> <p>Appuyer sur la touche « set » pour entrer.</p>	
<p>Le paramètre « A1 » s'affiche.</p> <p>Utiliser les touches « ⇩ » et « ⇧ » pour sélectionner le paramètre « dEF ».</p>	
<p>Appuyer sur la touche « set » pour entrer.</p>	
<p>La valeur par défaut est « OFF »</p> <p>Utiliser les touches « ⇩ » et « ⇧ » pour basculer de « OFF » à « On ».</p>	
<p>Appuyer sur la touche « set » pour confirmer.</p>	
<p>Après quelques secondes, revenir à « OFF ».</p> <p>Les paramètres ont été automatiquement réinitialisés.</p> <p>Appuyer trois fois sur la touche « esc » pour quitter.</p>	







Démarrage à distance ON/OFF

<p>Allumer le refroidisseur « ON » au moyen de l'interrupteur principal QS et attendre que « OFF » apparaisse sur l'écran.</p> <p>Appuyer simultanément sur les touches « esc » « set » pour entrer dans le type de paramètre « U ».</p>	
<p>Le paramètre « PAr » s'affiche.</p> <p>Appuyer sur la touche « set » pour entrer.</p>	
<p>Le paramètre « CF9 » s'affiche.</p> <p>Appuyer sur la touche « set » pour entrer.</p>	
<p>Le paramètre « A1 » s'affiche.</p> <p>Utiliser les touches « ⇩ » et « ⇧ » pour sélectionner le paramètre « A7 ».</p>	
<p>Appuyer sur la touche « set » pour entrer.</p>	
<p>La valeur par défaut est « 0 »</p> <p>Utiliser les touches « ⇩ » et « ⇧ » pour sélectionner le mode : (§ 4.5.1)</p>	
<p>Appuyer sur la touche « set » pour confirmer.</p>	
<p>Retour automatique à « A7 »</p> <p>Le paramètre a été enregistré.</p> <p>Appuyer trois fois sur la touche « esc » pour quitter.</p>	





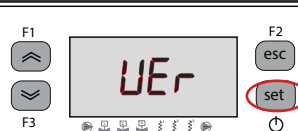

Tab. 2 Mode distant On/Off (A7)

0	On/Off distant désactivé
1	Mode distant On/Off activé et On/Off local activé. En cas de coupure de courant ou si l'interrupteur principal est en position d'arrêt, le refroidisseur doit être redémarré localement une fois l'alimentation électrique rétablie.
2	Uniquement On/Off distant, On/Off local désactivé

Version du logiciel (en lecture seule)

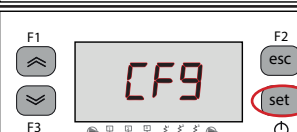
<p>Allumer le refroidisseur « ON » au moyen de l'interrupteur principal QS et attendre que « OFF » apparaisse sur l'écran.</p> <p>Appuyer simultanément sur les touches « esc » « set » pour entrer dans le type de paramètre « U ».</p>	
<p>Le paramètre « <i>PAR</i> » s'affiche.</p> <p>Appuyer sur la touche « set » pour entrer.</p>	
<p>Le paramètre « <i>CF9</i> » s'affiche.</p> <p>Appuyer sur la touche « set » pour entrer.</p>	
<p>Le paramètre « <i>A1</i> » s'affiche.</p> <p>Utiliser les touches « ⇩ » et « ⇧ » pour sélectionner le paramètre « <i>UER</i> ».</p>	
<p>Appuyer sur la touche « set » pour entrer.</p>	
<p>La version du logiciel est affichée</p>	
<p>Appuyer trois fois sur la touche « esc » pour quitter.</p>	

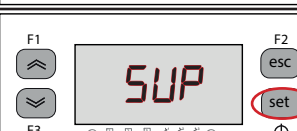
Activation du mode superviseur

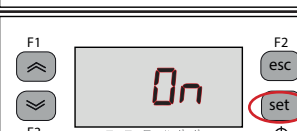
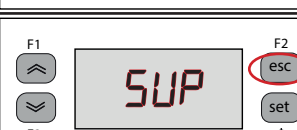
<p>Allumer le refroidisseur « ON » au moyen de l'interrupteur principal QS et attendre que « OFF » apparaisse sur l'écran.</p> <p>Appuyer simultanément sur les touches « esc » « set » pour entrer dans le type de paramètre « U ».</p>	
<p>Le paramètre « <i>PAR</i> » s'affiche.</p> <p>Appuyer sur la touche « set » pour entrer.</p>	
<p>Le paramètre « <i>CF9</i> » s'affiche.</p> <p>Appuyer sur la touche « set » pour entrer.</p>	
<p>Le paramètre « <i>A1</i> » s'affiche.</p> <p>Utiliser les touches « ⇩ » et « ⇧ » pour sélectionner le paramètre « <i>SUP</i> ».</p>	
<p>Appuyer sur la touche « set » pour entrer.</p>	
<p>La valeur par défaut est « <i>OFF</i> »</p> <p>Utiliser les touches « ⇩ » et « ⇧ » pour la change.</p>	
<p>Appuyer sur la touche « set » pour confirmer.</p>	
<p>Le paramètre a été enregistré.</p> <p>Appuyer trois fois sur la touche « esc » pour quitter.</p>	

Modbus (adresse)

<p>Allumer le refroidisseur « ON » au moyen de l'interrupteur principal QS et attendre que « OFF » apparaisse sur l'écran.</p> <p>Appuyer simultanément sur les touches « esc » et « set » pour entrer dans le type de paramètre « U ».</p>	
<p>Le paramètre « <i>PAR</i> » s'affiche.</p> <p>Appuyer sur la touche « set » pour entrer.</p>	
<p>Le paramètre « <i>CF9</i> » s'affiche.</p> <p>Appuyer sur la touche « set » pour entrer.</p>	
<p>Le paramètre « <i>A1</i> » s'affiche.</p> <p>Utiliser les touches « ↓ » et « ↑ » pour sélectionner le paramètre « <i>CF30</i> ».</p>	
<p>Appuyer sur la touche « set » pour entrer.</p>	
<p>La valeur par défaut est « 1 »</p> <p>Utiliser les touches « ↓ » et « ↑ » pour modifier l'adresse.</p>	
<p>Appuyer sur la touche « set » pour confirmer.</p>	
<p>Le paramètre a été enregistré.</p> <p>Appuyer trois fois sur la touche « esc » pour quitter.</p>	

Modbus (vitesse de transmission)

<p>Allumer le refroidisseur « ON » au moyen de l'interrupteur principal QS et attendre que « OFF » apparaisse sur l'écran.</p> <p>Appuyer simultanément sur les touches « esc » et « set » pour entrer dans le type de paramètre « U ».</p>	
<p>Le paramètre « <i>PAR</i> » s'affiche.</p> <p>Appuyer sur la touche « set » pour entrer.</p>	
<p>Le paramètre « <i>CF9</i> » s'affiche.</p> <p>Appuyer sur la touche « set » pour entrer.</p>	
<p>Le paramètre « <i>A1</i> » s'affiche.</p> <p>Utiliser les touches « ↓ » et « ↑ » pour sélectionner le paramètre « <i>CF31</i> ».</p>	
<p>Appuyer sur la touche « set » pour entrer.</p>	
<p>La valeur par défaut est « 5 »</p> <p>Utiliser les touches « ↓ » et « ↑ » pour modifier le protocole. (§ 4.5.1 - Tab. 3)</p>	
<p>Appuyer sur la touche « set » pour confirmer.</p>	
<p>Le paramètre a été enregistré.</p> <p>Appuyer trois fois sur la touche « esc » pour quitter.</p>	

Tab.3 Vitesse de transmission (en option) (CF31)

1	2400	3	9600	5	38400	7	115200
2	4800	4	19200	6	57600		

Modbus (protocole)

<p>Allumer le refroidisseur « ON » au moyen de l'interrupteur principal QS et attendre que « OFF » apparaisse sur l'écran.</p> <p>Appuyer simultanément sur les touches « esc » et « set » pour entrer dans le type de paramètre « U ».</p>	
<p>Le paramètre « <i>PAR</i> » s'affiche.</p> <p>Appuyer sur la touche « set » pour entrer.</p>	
<p>Le paramètre « <i>CF9</i> » s'affiche.</p> <p>Appuyer sur la touche « set » pour entrer.</p>	
<p>Le paramètre « <i>A1</i> » s'affiche.</p> <p>Utiliser les touches « ↓ » et « ↑ » pour sélectionner le paramètre « <i>CF32</i> ».</p>	
<p>Appuyer sur la touche « set » pour entrer.</p>	
<p>La valeur par défaut est « 1 »</p> <p>Utiliser les touches « ↓ » et « ↑ » pour modifier la vitesse de transmission. (§ 4.5.1 - Tab. 4)</p>	
<p>Appuyer sur la touche « set » pour confirmer.</p>	
<p>Le paramètre a été enregistré.</p> <p>Appuyer trois fois sur la touche « esc » pour quitter.</p>	

Tab.4 Protocole modbus (en option) (CF32)

1	PAIRE	2	NULLE	3	IMPAIRE
---	-------	---	-------	---	---------

Remarque : si vous modifiez les paramètres du MODBUS, vous devez éteindre le refroidisseur puis le rallumer pour valider les nouveaux paramètres.

Activation de ERD

<p>Allumer le refroidisseur « ON » au moyen de l'interrupteur principal QS et attendre que « OFF » apparaisse sur l'écran.</p> <p>Appuyer simultanément sur les touches « esc » et « set » pour entrer dans le type de paramètre « U ».</p>	
<p>Le paramètre « <i>PAR</i> » s'affiche.</p> <p>Appuyer sur la touche « set » pour entrer.</p>	
<p>Le paramètre « <i>CF9</i> » s'affiche.</p> <p>Appuyer sur la touche « set » pour entrer.</p>	
<p>Le paramètre « <i>A1</i> » s'affiche.</p> <p>Utiliser les touches « ↓ » et « ↑ » pour sélectionner le paramètre « <i>ErD</i> ».</p>	
<p>Appuyer sur la touche « set » pour entrer.</p>	
<p>La valeur par défaut est « OFF »</p> <p>Utiliser les touches « ↓ » et « ↑ » pour la change.</p>	
<p>Appuyer sur la touche « set » pour confirmer.</p>	
<p>Le paramètre a été enregistré.</p> <p>Appuyer trois fois sur la touche « esc » pour quitter.</p>	

Lorsque le paramètre ERD est activé : La température de consigne de l'eau change en fonction de la température ambiante. La fonction n'est active que si le contrôle de la précision de la température est désactivé (CPT=OFF).

4.6.2 Contrôle de la température « CNP »

Réglage du contrôle de la température

<p>Allumer le refroidisseur « ON » au moyen de l'interrupteur principal QS et attendre que « OFF » apparaisse sur l'écran.</p> <p>Appuyer simultanément sur les touches « esc » et « set » pour entrer dans le type de paramètre « U ».</p>	
<p>Le paramètre « PAr » s'affiche.</p> <p>Appuyer sur la touche « set » pour entrer.</p>	
<p>Le paramètre « CF9 » s'affiche.</p> <p>Utiliser les touches « >> » et « << » pour sélectionner le paramètre « CNP ».</p>	
<p>Appuyer sur la touche « set » pour entrer.</p>	
<p>Le paramètre « SEt » s'affiche.</p> <p>Appuyer sur la touche « set » pour entrer.</p>	
<p>La valeur par défaut est « 13.0 »</p> <p>Utiliser les touches « >> » et « << » pour modifier la valeur.</p>	
<p>Appuyer sur la touche « set » pour confirmer.</p>	
<p>Le paramètre a été enregistré.</p> <p>Appuyer trois fois sur la touche « esc » pour quitter.</p>	

Important : La température doit être réglée entre 1°C et 5°C par des techniciens spécialisés sur la base des instructions figurant dans le manuel d'entretien de ce produit.

Réglage du différentiel de température

<p>Allumer le refroidisseur « ON » au moyen de l'interrupteur principal QS et attendre que « OFF » apparaisse sur l'écran.</p> <p>Appuyer simultanément sur les touches « esc » et « set » pour entrer dans le type de paramètre « U ».</p>	
<p>Le paramètre « PAr » s'affiche.</p> <p>Appuyer sur la touche « set » pour entrer.</p>	
<p>Le paramètre « CF9 » s'affiche.</p> <p>Utiliser les touches « >> » et « << » pour sélectionner le paramètre « CNP ».</p>	
<p>Appuyer sur la touche « set » pour entrer.</p>	
<p>Le paramètre « SEt » s'affiche.</p> <p>Utiliser les touches « >> » et « << » pour sélectionner le paramètre « d i F l ».</p>	
<p>Appuyer sur la touche « set » pour entrer.</p>	
<p>La valeur par défaut est « 4.0 »</p> <p>Utiliser les touches « >> » et « << » pour modifier la valeur.</p>	
<p>Appuyer sur la touche « set » pour confirmer.</p>	
<p>Le paramètre a été enregistré.</p> <p>Appuyer trois fois sur la touche « esc » pour quitter.</p>	

4.6.3 Paramètre sonde « bt 1 »

Sonde « bt 1 ».

<p>Allumer le refroidisseur « ON » au moyen de l'interrupteur principal QS et attendre que « OFF » apparaisse sur l'écran.</p> <p>Appuyer simultanément sur les touches « esc » et « set » pour entrer dans le type de paramètre « U ».</p>	
<p>Le paramètre « PA_r » s'affiche.</p> <p>Appuyer sur la touche « set » pour entrer.</p>	
<p>Le paramètre « CF9 » s'affiche.</p> <p>Utiliser les touches « >> » et « << » pour sélectionner le paramètre « bt 1 ».</p>	
<p>Appuyer sur la touche « set » pour entrer.</p>	
<p>Le paramètre « HA 1 » s'affiche.</p> <p>Appuyer sur la touche « set » pour entrer.</p>	
<p>La valeur par défaut est « 60.0 »</p> <p>Utiliser les touches « >> » et « << » pour modifier la valeur.</p>	
<p>Appuyer sur la touche « set » pour confirmer.</p>	
<p>Le paramètre a été enregistré.</p> <p>Appuyer trois fois sur la touche « esc » pour quitter.</p>	

Même séquence pour la sonde « bt2 ».

4.7 Visualisation sondes/ ventilateur/ compresseur

<p>Refroidisseur en marche.</p> <p>Appuyer sur la touche « << » pour afficher la page des avertissements..... bt 1, bt 2, bt 3, bP 1.....</p>	
<p>Sélectionner la sonde et attendre quelques secondes. (Ex. BT2)</p>	
<p>La valeur de la sonde bt 2 s'affiche.</p>	
<p>Il est conseillé de toujours revenir à la sonde bt 1</p>	

Description:

bt 1 : capteur de température de sortie d'eau
 bt 2 : capteur de température de l'évaporateur
 bt 3 : capteur de température ambiante
 bt 10 : capteur de température du tableau électrique (option)
 bP 1 : transmetteur du circuit 1
 bP 2 : transmetteur du circuit 2 (du modèle ICEP080)























F... : fonctionnement du ventilateur:

F... : ventilateur éteint
 F- : ventilateur 1 allumé, ventilateur 2/3 éteint: (2 = du modèle ICEP022) (3 = du modèle ICEP080)
 F-- : ventilateurs 1 et 2 allumés, ventilateur 3 éteint, (2 = du modèle ICEP022) (3 = du modèle ICEP080)
 F--- : ventilateurs 1,2 et 3 allumés (du modèle ICEP080)

IC2 : fonctionnement du compresseurs:

IC- : compresseurs désactivés
 IC- : compresseurs éteint
 IC- : compresseur 1 allumé, compresseur 2 éteint
 IC2 : compresseurs 1 et 2 allumés; (du modèle ICEP055)
 IC- : avec " I " clignotant compresseur prêt à démarrer, compresseur 2 éteint

4.8 Réglage de l'heure/la date



<p>Allumer le refroidisseur « ON » au moyen de l'interrupteur principal QS et attendre que « OFF » apparaisse sur l'écran.</p> <p>Appuyer simultanément sur les touches «  » et «  » pour afficher le menu « Date/heure ».</p>	
<p>Le paramètre « FrEE » s'affiche.</p> <p>Appuyer sur la touche «  » pour entrer.</p>	
<p>Le paramètre « A1 » s'affiche.</p> <p>Utiliser les touches «  » et «  » pour sélectionner le paramètre « CL ».</p>	
<p>Appuyer sur la touche «  » pour entrer.</p>	
<p>Le paramètre « HOUR » s'affiche.</p> <p>Appuyer sur la touche pendant 5 secondes «  ».</p> <p>Le paramètre se met à clignoter.</p>	
<p>Utiliser les touches «  » et «  » pour sélectionner la date, l'heure ou l'année et les modifier.</p>	
<p>Appuyer sur la touche «  » pour entrer.</p>	
<p>Utiliser les touches «  » et «  » pour modifier la valeur (ex : année)</p>	
<p>Appuyer sur la touche «  » pour confirmer.</p>	

Utiliser les touches «  » et «  » pour modifier une autre valeur (ex : date)



Appuyer sur la touche «  » pour quitter
Le paramètre cesse de clignoter.













Appuyer simultanément sur les touches «  » et «  » pour quitter.



⚠ La mémoire de l'« horloge/date » dure trois jours au maximum. Si le contrôleur reste sans alimentation pendant plus de trois jours, l'heure/le mois/l'année paramétrés seront donc perdus. Régler l'horloge lors de la mise en marche de la machine et chaque fois que cela est nécessaire.







4.9 Gestion des alarmes

<p>En présence d'une alarme, le code d'alarme et un symbole s'affichent dans le coin supérieur gauche de l'écran.</p> <p> Fixe = alarme présente Clignotant = avertissement présent/ Alarme réinitialisable</p>	
<p>Appuyer sur la touche « set » pour entrer.</p>	
<p>Le paramètre « ALH, » s'affiche.</p> <p>Appuyer sur la touche «  » pour sélectionner le paramètre « AL ».</p>	
<p>Appuyer sur la touche « set » pour entrer.</p>	
<p>Le code de l'alarme s'affiche ex. :« Er04 ».</p> <p>Appuyer sur la touche «  » pour contrôler la présence éventuelle d'autres alarmes.</p>	
<p>Remédier à l'anomalie avant de procéder à la réinitialisation. Une fois l'anomalie éliminée, le symbole d'alarme commence à clignoter. Il est maintenant possible de procéder à la réinitialisation.</p>	
<p>Appuyer sur la touche « esc » jusqu'à la suppression de l'alarme.</p>	

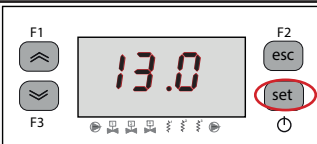
Liste des alarmes et avertissements

Code	Description	Action	Réinitialisation
Er01	Coupure ou rupture du capteur bt1	Alarme	M
Er02	Coupure ou rupture du capteur bt2	Alarme	M
Er03	Coupure ou rupture du capteur bt3	Alarme	A
Er05	Coupure ou rupture du capteur bt10	Alarme	A
Er06	Coupure ou rupture du capteur bP1	Alarme	M
Er08	Circuit du pressostat de haute pression 1	Alarme	M
Er09	Circuit du pressostat de basse pression 1	Alarme	M
Er12	Haute température bt1	Alarme	M
Er13	Basse température bt1	Alarme	A
Er14	Haute température bt2	Alarme	M
Er15	Basse température bt2	Alarme	M
Er16	Haute température bt3	Alarme	A
Er17	Basse température bt3	Alarme	A
Er18	Protection thermique du compresseur 1	Alarme	M
Er20	Protection thermique de la pompe 1	Alarme	M
Er22	Bas niveau d'eau / Pressostat différentiel	Alarme	M
Er23	Moniteur phase	Alarme	M
Er24	Rupture ou déconnexion de l'extension	Alarme	M
Er25	Nombre d'heures de fonctionnement du compresseur 1 dépassé	Avertissement	M
Er27	Nombre d'heures de fonctionnement de l'unité dépassé	Avertissement	M
Er28	Mémoire d'horloge	Avertissement	A
Er29	Configuration du refroidisseur	Avertissement	A

4.10 Historique des alarmes





Refroidisseur en marche. Appuyer sur la touche « set » pour afficher la page des alarmes.	
Appuyer sur la touche « set » pour quitter	
Utiliser les touches «  » et «  » pour afficher les paramètres. (§ 4.5.5)	
Appuyer sur la touche « set » pour afficher la valeur.	

5 Entretien

• La machine est conçue et construite pour garantir un fonctionnement continu ; la durée de ses composants dépend cependant directement de l'entretien effectué.

-  En cas de demande d'assistance ou de pièces détachées, identifier la machine (modèle ou numéro de série) en lisant la plaque d'identification placée sur la carrosserie de l'unité. (**www.polewr.com.**)

5.1 Recommandations générales

-  Avant tout entretien vérifier que le réfrigérateur ne soit plus alimenté.
-  Utiliser toujours des pièces de rechange d'origine ; dans le cas contraire, le constructeur est déchargé de toute responsabilité pour le mauvais fonctionnement de la machine.
-  En cas de fuite du réfrigérant, appeler un professionnel qualifié et agréé par le constructeur.
-  La vanne ou valve Schrader ne doit être utilisée qu'en cas d'anomalie de fonctionnement de la machine : dans le cas contraire, les dommages causés par une charge de réfrigérant incorrecte ne seront pas reconnus au titre de la garantie.

5.2 Réfrigérant













Opération de charge : les dommages éventuels causés par une charge incorrecte effectuée par un personnel non habilité ne seront pas reconnus au titre de la garantie. 

-  L'appareil contient des gaz à effet de serre fluorés.
Le fluide frigorigène R513A à température et pression normales est un gaz incolore appartenant au SAFETY GROUP A1 - EN378 (fluide groupe 2 selon la directive PED 2014/68/UE); GWP (Global Warming Potential) = 629.

-  En cas de fuite de réfrigérant, aérer le local.

5.3 Entretien préventif ou prédictif

Pour garantir dans le temps l'efficacité maximum et la fiabilité de l'appareil procéder comme suit :

Description opération d'entretien	Périodicité d'entretien recommandée (conditions de fonctionnement standard)			
	Tous les jours	Tous les 6 mois	Tous les 12 mois	Tous les 36 mois
<p>Opération</p> <p>contrôler  Service </p>				
Contrôler que le témoin POWER ON est allumé				
Contrôler les indicateurs du tableau des commandes.				
Nettoyer les ailettes du condenseur				
Contrôler la consommation électrique.				
Contrôler les fuites de réfrigérant.				
Contrôler et nettoyer la Soupape de sûreté à eau (si présent)*				
Contrôler le système électrique et le panneau électrique**				
Contrôler les sondes de température. Remplacer si nécessaire.				 
Kit d'entretien				

 The following are available (see par 7.):

- a) Kit d'entretien: kit électrique; kit compresseur; kit ventilateur; kit évaporateur; kit pompe; kit réservoir eau;
- b) pièces détachées.

*Les soupapes de sécurité doivent être contrôlées périodiquement pour s'assurer qu'elles fonctionnent parfaitement. Avec le temps, des impuretés peuvent se déposer près du clapet ; un rinçage périodique du siège est donc nécessaire. Pour le rinçage, il faut purger manuellement la soupape en tournant le bouton dans le sens indiqué par les flèches.

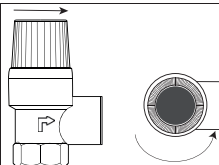

Important : Après le rinçage, vérifiez que la pression de fonctionnement est rétablie.



** Pendant l'entretien de routine, le système électrique de la machine et le panneau électrique

doivent également être vérifiés selon la législation locale. En outre, une inspection visuelle de l'équipement et des conducteurs électriques doit systématiquement être effectuée dans la mesure du possible. Le serrage correct des bornes des composants d'alimentation doit aussi être vérifié, selon les couples de serrage indiqués dans le schéma électrique.

5.4 Mise au rebut

Le fluide frigorigène et le lubrifiant (huile) contenus dans le circuit devront être récupérés selon la législation antipollution.

La récupération du fluide réfrigérant est effectuée avant la destruction définitive de l'équipement ((UE) N° 517/2014 art.8).

 RECYCLAGE	 DÉMANTÈLEMENT
charpenterie	acier/résines époxy, polyester
réservoir	aluminium/cuivre/acier
tuyauterie/collecteurs	cuivre/aluminium/acier au carbone
isolation tuyauterie	caoutchouc nitrile (NBR)
compresseur	acier/cuivre/aluminium/huile
condenseur	acier/cuivre/aluminium
pompe	acier/fonte/laiton
ventilateur	aluminium
réfrigérant	R513A
vannes	laiton/cuivre
câbles électriques	cuivre/PVC

Les équipements contenant des composants électriques doivent être éliminés séparément avec les déchets électriques et électroniques conformément à la législation locale et en vigueur.



6 Dépannage

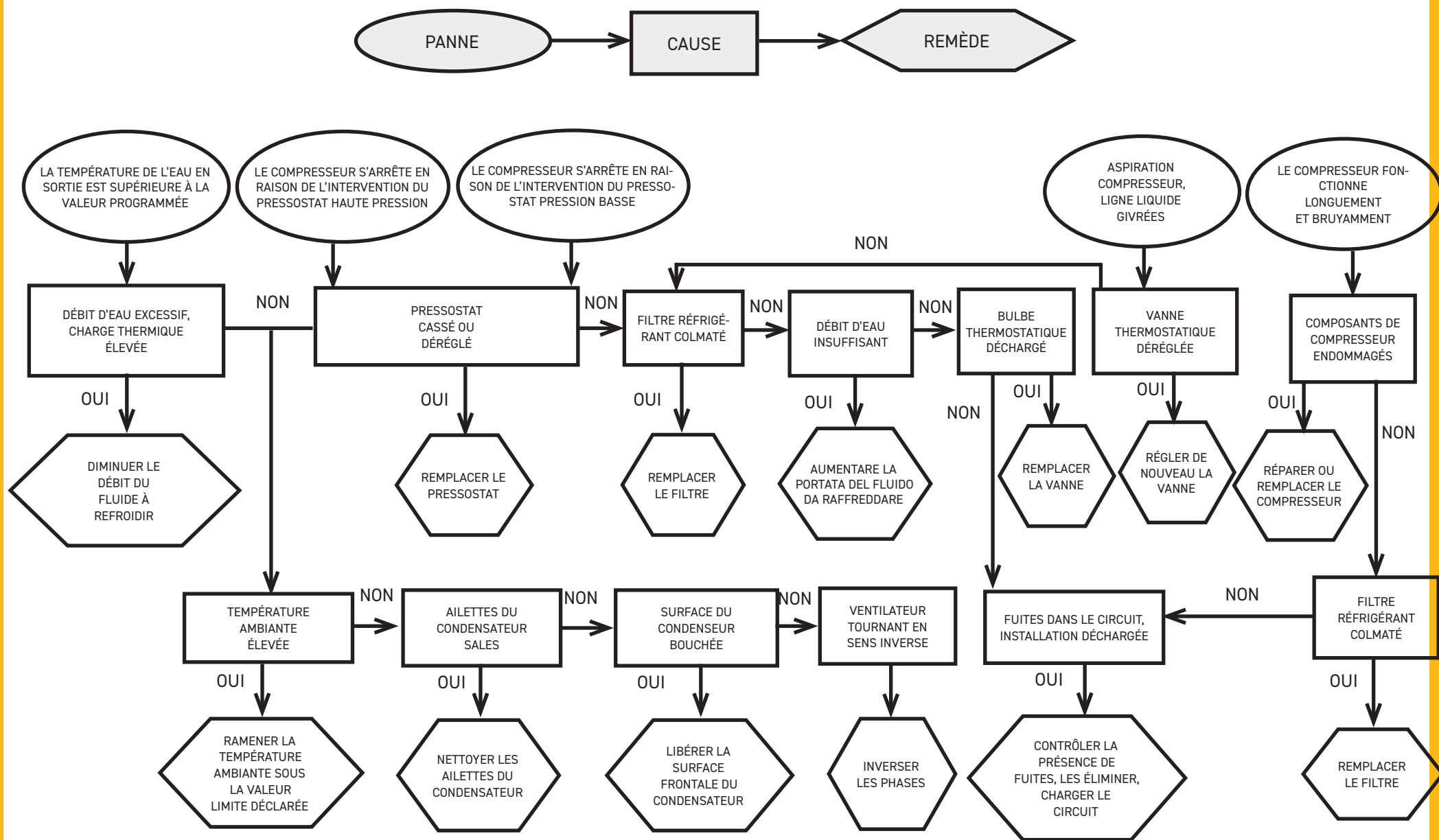

1 Sicherheit	2
1.1 Bedeutung des Handbuchs.....	2
1.2 Warn-, und sonstige Hinweise.....	2
1.3 Sicherheitshinweise.....	2
1.4 Restrisiken.....	2
2 Einführung	3
2.1 Transport.....	3
2.2 Handhabung.....	3
2.3 Inspektion.....	3
2.4 Lagerung.....	3
3 Installation	3
3.1 Betriebsbereich.....	3
3.2 Versionen.....	3
3.3 Wasserkreis.....	3
3.3.1 Kontrollen und Anschluss.....	3
3.3.2 Wasser und Äthylenglykol.....	4
3.3.3 Expansionsgefäß.....	4
3.4 Stromkreis.....	5
3.4.1 Kontrollen und Anschluss.....	5
3.4.2 Allgemeiner Alarm.....	5
3.4.3 ON/OFF-Fernsteuerung.....	5
3.5 Wassergekühlte Version (W).....	5
4 Steuerung	6
4.1 Bedienkonsole.....	6
4.2 Bedeutung von Symbolen.....	6
4.3 So starten Sie den Kühler.....	6
4.3.1 Einstellungen bei der Inbetriebnahme.....	6
4.3.2 Beginnend mit Hochtemperaturwasser.....	6
4.4 So stoppen Sie den Kühler.....	7
4.5 Parametereinstellungen.....	7
4.5.1 Kühlerparameter (CF9).....	7
4.5.2 Temperaturregelung (CFP).....	7
4.5.3 Wartungsparameter (Fnt).....	7
4.5.4 Sondenparameter (bE 1, bE 2).....	7
4.5.5 Alarm-Protokoll (RLH 1).....	7
4.6 Parameter ändern (User).....	8
4.6.1 Kühlerparameter „CF9“.....	8
4.6.2 Temperaturregelung „CFP“.....	13
4.6.3 Sondenparameter „bE 1“.....	14
4.7 Visualisierung Sonden/ Lüfter/ Kompressor.....	14
4.8 Einstellung von Uhrzeit/ Datum.....	15
4.9 Alarm-Management.....	16
4.10 Alarm-Protokoll.....	17
5 Wartung	17
5.1 Allgemeine Hinweise.....	17
5.2 Kältemittel.....	17
5.3 Wartungsprogramm.....	18
5.4 Entsorgung.....	18

7 Anhang
7.1 Legende
7.2 Installationsplan
7.3 Handhabung - Betriebsbereich
7.4 Technische Daten
7.5 Abmessungen
7.6 Ersatzteilliste
7.7 Explosionszeichnungen
7.8 Kreisplan
7.9 Stromlaufplan

1 Sicherheit

1.1 Bedeutung des Handbuchs

- Das Handbuch während der gesamten Betriebslebensdauer der Einheit aufbewahren.
- Vor der Ausführung von Schaltvorgängen usw. ist das Handbuch aufmerksam durchzulesen.
- Es können jederzeit Änderungen am Handbuch vorgenommen werden; für aktualisierte Informationen ist die Version an der Einheit einzusehen.

1.2 Warn-, und sonstige Hinweise



Hinweise zur Vermeidung von Personenschäden.



Hinweis zur Vermeidung Machinenschäden..





Nur durch erfahrenen und autorisierten Techniker möglich.



Aufgeführte Symbole, deren Bedeutung im Abschnitt 7 beschrieben ist.

1.3 Sicherheitshinweise

 Jede Einheit ist mit einem elektrischen Hauptschalter ausgestattet, damit Arbeiten unter Sicherheitsbedingungen ausgeführt werden können. Aus Sicherheitsgründen vor der Ausführung von Wartungsarbeiten den Strom immer mit diesem Hauptschalter ausschalten.

 **Das Handbuch richtet sich an Endbenutzer zur Ausführung von Arbeiten bei geschlossenen Schutzpaneelen: Arbeit Installation/Inbetriebnahme/Wartung und bei denen es notwendig ist, die Paneele mit Werkzeug zu öffnen, dürfen nur von Fachpersonal ausgeführt werden.**

 **Nur zur Installation an Orten, die für die Öffentlichkeit nicht zugänglich sind, entweder an einem gesicherten Ort mit beschränktem Zugang oder auf einer Höhe von mindestens 2,5 m oder in gesicherten Dachbereichen, es sei denn, sie werden von einer für ihre Sicherheit verantwortlichen Person beaufsichtigt oder in die Verwendung des Geräts eingewiesen.**

 Der Montageabstand von der Wand und der freie Betriebsraum sind in Abschnitt 7.3 angegeben.



 **Achtung: Beachten Sie die in Abschnitt 7.4 angegebenen Min./Max.-Temperaturen und -Drücke sowie den in Abschnitt 7.2 angegebenen Gesamtbetriebstemperaturbereich.**

 **Alle Einheiten können im Freien installiert werden.**

 **Alle elektrischen Anschlüsse müssen den Anforderungen der einschlägigen lokalen Vorschriften genügen.**

ten des Installationsorts genügen.

 Nicht die auf dem Typenschild angegebenen Projektvorgaben überschreiten.

  Es obliegt dem Benutzer, Lasten zu vermeiden, die vom internen Ruhedruck abweichen. In Erdbebengebieten müssen für die Einheit passende Schutzmaßnahmen vorgesehen werden. Die Einheit ausschließlich für professionelle und bestimmungsgemäße Anwendungen einsetzen.

 Der Anwender hat alle Anwendungsaspekte, in denen das Produkt installiert ist, zu prüfen und die entsprechenden industriellen Sicherheitsnormen sowie die für das Produkt geltenden Vorschriften einzuhalten, die im Bedienerhandbuch und sonstigen Unterlagen, die mit der Einheit geliefert werden, enthalten sind.

Umbauten, Veränderungen und Austausch von Bauteilen durch nicht autorisiertes Personal sowie eine bestimmungsfremde Benutzung der Einheit befreit den Hersteller von jeglichen Haftungsansprüchen und führt zum Erlöschen der Garantie.

Der Hersteller übernimmt keinerlei Haftung, weder gegenwärtig noch zukünftig, für Personen- und Sachschäden sowie Beschädigungen der Einheit, die auf Nachlässigkeit der Bediener, die Nichteinhaltung aller im vorliegenden Handbuch aufgeführten Anleitungen und die Nichteinhaltung der gültigen Vorschriften für die Anlagensicherheit zurückzuführen sind.

Der Hersteller übernimmt keine Haftung für eventuell durch Austausch und/oder Änderung an der Verpackung entstandene Schäden.

Der Anwender hat sich zu vergewissern, dass die für die Auswahl der Anlage gelieferten Spezifikationen und/oder deren Bauteile und/oder Optionen für die korrekte bzw. in vernünftiger Weise vorhersehbare Nutzung der Anlage bzw. der Bauteile ausreichen.

 **ACHTUNG:Der Hersteller behält sich das Recht vor, die in dem vorliegenden Handbuch enthaltenen Informationen ohne Vorbescheid zu ändern. Zur vollständigen und aktuellen Information wird empfohlen, das mit dem Gerät gelieferte Handbuch aufmerksam durchzulesen.**

1.4 Restrisiken

Die Installation, das Ein- und Ausschalten sowie die Wartung des Kaltwassersatzes müssen unbedingt unter Beachtung der Vorgaben in der technischen Dokumentation des Produkts und mit Gewährleistung der Sicherheitsbedingungen zur Vermeidung bzw. Vorbeugung jeglicher Gefahren ausgeführt werden.

Die Risiken, die in der Projektierungsphase nicht beseitigt werden konnten, sind in der nachfolgenden Tabelle aufgeführt..

Betreffender Teil	Restrisiko	Art und Weise	Vorsichtsmaßnahmen
Wärmetauscher Verflüssiger	Kleine Schnittverletzungen	Kontakt	Kontakt vermeiden, Schutzhandschuhe anziehen.
Lüftungsgitter und Ventilator	Verletzungen	Einfügen von spitzen Gegenständen durch die Gitterschlitze während des Ventilatorbetriebs.	Keine Gegenstände jedweder Art in die Gitterschlitze der Ventilatoren einfügen oder auf die Gitter legen.
Innenbereich d.Einheit: Verdichter und druckseitige Leitung	Verbrennungen	Kontakt	Kontakt vermeiden, Schutzhandschuhe anziehen.

Betreffender Teil	Restrisiko	Art und Weise	Vorsichtsmaßnahmen
Innenbereich d. Einheit: Metallteile und Elektrokabel	Vergiftungen, Stromschläge, schwere Verbrennungen	Defekt an der Isolierung der Versorgungskabel vor dem Schaltschrank der Einheit; Metallteile unter Spannung.	Geeigneter elektrischer Schutz der Versorgungsleitung; maximale Sorgfalt bei der Ausführung der Erdung für die Metallteile.
Außenbereich d. Einheit: umfangsseitig	Vergiftungen, schwere Verbrennungen	Brand infolge Kurzschluss oder Überhitzung der Versorgungsleitung vor dem Schaltschrank der Einheit.	Querschnitt der Kabel und Schutzsystem der elektrischen Versorgungsleitung gemäß den einschlägigen Normen ausführen.

2 Einführung

Die Motoren von Verdichtern, Pumpen und Ventilatoren sind durch einen Schutzschalter vor Überhitzung geschützt.

2.1 Transport

Die verpackte Einheit muss:

- stets in vertikaler Position transportiert werden;
- gegen witterungsbedingte Einflüsse geschützt werden;
- gegen Stöße geschützt werden.

2.2 Handhabung

Einen für das anzuhebende Gewicht geeigneten Gabelstapler verwenden und bei der Handhabung jegliche Stöße vermeiden.

2.3 Inspektion

- Die Einheiten werden im Werk zusammengebaut, verkabelt, mit Kältemittel und Öl befüllt und abgenommen.
- Bei der Anlieferung der Einheit ist deren Zustand zu überprüfen; eventuelle Schäden sind unverzüglich dem Transportunternehmen zu melden.
- Das Auspacken der Einheit möglichst nahe am Installationsort ausführen.

2.4 Lagerung

- Die verpackte Einheit an einem sauberen Ort aufbewahren, der gegen Feuchtigkeit und witterungsbedingte Einflüsse geschützt ist.
- die Einheiten nicht übereinander stapeln;
- die Anleitung auf der Verpackung befolgen.

3 Installation

 Zur Gewährleistung einer optimalen Installation sind die Hinweise in den Abschnitten 7. zu beachten.

 Das installierte Produkt muss angemessen gegen Brandgefahr geschützt sein (Ref. EN378-3)

 **Es wird empfohlen, alle Kühler mit adäquaten Vorfiltern in der Nähe des Wassereintritts in den Kühler auszustatten (Filtrationsgrade : min.05mm; max1.0mm).**

 **Kühlflüssigkeiten**

Die Kühlflüssigkeiten müssen mit den verwendeten Materialien kompatibel sein.

Beispiele für zur Anwendung kommende Flüssigkeiten sind **Wasser oder Mischungen von Wasser und Propylen- oder Äthylenglykol.**

Die Kühlflüssigkeiten dürfen nicht entzündbar sein.

Wenn die zu kühlenden Flüssigkeiten gefährliche Stoffe enthalten (wie z.B. Ethylen- oder Propylenglykol) muss die eventuell ausgetretene Flüssigkeit sofort aufgefangen werden, da sie umweltgefährdend ist. Halten Sie sich im Falle einer Entleerung des Hydraulikkreislaufs an die einschlägigen Bestimmungen zum Umweltschutz.

3.1 Betriebsbereich

 **Umfangsseitig um die Einheit ist ein Freiraum von 1,5 m erforderlich. Bei Modellen mit vertikalem Kondensationsluftausstoß müssen über dem Gerät mindestens 2,0 m frei bleiben.**

3.2 Versionen

Luftgekühlte Version: Axialventilatoren (A)

Sicherstellen, dass keine Rückzirkulationen der Kühlluft auftreten können.

Auf keinen Fall die Lüftungsgitter bedecken.

Bei Ausführungen mit Axialventilatoren wird von der Kanalisierung der Abluft abgeraten.

Wassergekühlte Version (W)

Stammt das dem Kondensator zugeführte Wasser nicht aus einem geschlossenen Kreislauf, muss auf dem Kondenswassereinlass ein Netzfilter installiert werden.

Für besonderes Kühlwasser (entionisiertes, entmineralisiertes oder destilliertes Wasser) sind die für den Kondensator vorgesehenen Standardmaterialien u. U. nicht geeignet. In diesem Fall bitte vorher Rücksprache mit dem Hersteller halten.

3.3 Wasserkreis

3.3.1 Kontrollen und Anschluss

 Vor dem Anschluss des Kaltwassersatzes und der Befüllung des Kreises ist sicherzustellen, dass die Leitungen sauber sind. Anderenfalls muss eine sorgfältige Spülung durchgeführt werden

  **Wenn der Wasserkreislauf unter Druck steht und geschlossen ist, wird ein auf 6 bar geeichtes Sicherheitsventil eingebaut.**

 Am Wasser Ein- und Austritt sollten stets geeignete Siebfilter installiert werden.

 Wird der Wasserkreis durch automatisch ansprechende Ventile gesperrt, ist die Pumpe durch

geeignete Wasserschlagn-Schutzsysteme zu schützen.

 Falls der Kreislauf vor einem längeren Stillstand der Maschine entleert wird, ist es angebracht, das Pumpenrad mit Schmierflüssigkeit einzufetten, um eine Blockierung des Rads bei der Wiederinbetriebsetzung zu vermeiden. Das eventuell blockierte Pumpenrad von Hand wie folgt freisetzen: Die hintere Pumpenabdeckung abnehmen und vorsichtig den Kunststoffflügel drehen. Sollte die Welle weiterhin festsitzen, den Flügel ausbauen und direkt die Welle drehen. Nach dem Freisetzen der Welle den Pumpenflügel einbauen und die Abdeckung wieder anbringen.

Vorabkontrollens

1. Kontrollieren, ob eventuelle Absperrventile im Wasserkreislauf geöffnet sind.
2. Ist der Wasserkreis in geschlossener Ausführung, kontrollieren, ob ein Expansionsgefäß mit geeigneter Kapazität installiert wurde.

Anschluss

1. Den Kaltwassersatz mit den zu diesem Zweck an der Rückseite der Einheit vorgesehenen Anschlüssen an die Zu- und Ableitungen anschließen.
Es empfiehlt sich der Gebrauch von elastischen Kupplungen, um der Steifigkeit des Systems entgegenzuwirken.
2. Den Wasserkreislauf über den vorgesehenen Füllanschluss auf der Rückseite des Kaltwassersatzes befüllen ().
3. Am Tank befindet sich ein Entlüftungsventil, das bei der Befüllung manuell zu öffnen ist. Weist der Wasserkreis höher liegende Punkte auf, sind diese mit entsprechenden Entlüftungsventilen zu versehen und ebenfalls beim Füllen zu öffnen.
4. Es empfiehlt sich, die Ein- und Auslaufleitungen mit Sperrventil zu versehen, sodass bei Wartungsarbeiten eine Trennung der Einheit vom Kreis möglich ist.
5. Arbeitet der Kaltwassersatz mit offenem Behälter, muss die Installation der Pumpe an der Saugseite des Behälters und an der Druckseite des Kaltwassersatzes erfolgen..

 **Warnung (Modelle 022-120): Die Maschine ist mit einer automatischen Schutzeinrichtung für den Tank ausgestattet.**

Wenn der Wassereinfluss versehentlich geschlossen wird, während die Pumpe läuft und der Wasserauslass geöffnet ist, tritt mit dem wahrscheinlichen Eingreifen des Füllstandensensors Luft in den Tank ein. Der Hydraulikkreis muss entlüftet werden, um die Luft zu entfernen.

Nachfolgende Kontrollen

1. Kontrollieren, ob der Tank und der Wasserkreis vollständig befüllt wurden und korrekt entlüftet wurden.
2. Der Wasserkreislauf muss immer gefüllt sein. Diesbezüglich regelmäßige Kontrollen ausführen und bei Bedarf nachfüllen, oder die Anlage mit einem automatischen Füllset versehen.

Eigenschaften des wasser

Falls in der Lieferung nicht vorgesehen, einen Siebfilter am Einlauf des wasser installieren.

 Eigenschaften des wasser:

Temperature	≥50°F (10°C)	CL ⁻	<50 ppm
ΔT IN/OUT	5-15°C	CaCO ₃	70-150 ppm
Max % Glykole	50	O ₂	<0.1 ppm
Druck	43.5-145 PSig (3-10 barg)	Fe	<0.2 ppm
PH	7.5-9	NO ₃	<2 ppm

Elektrische Leitfähigkeit	10-500 µS/cm	HCO ₃ ⁻	70-300 ppm
Langelier- Sättigungsindex	0-1	H ₂ S	<0.05 ppm
SO ₄ ²⁻	<50 ppm	CO ₂	<5 ppm
NH ₃	<1 ppm	Al	<0.2 ppm

Für besonderes wasser am Einlauf (entionisiertes, entmineralisiertes oder destilliertes wasser) sind die für den Kaltwassersatz vorgesehenen Standardmaterialien u. U. nicht geeignet. In diesem Fall bitte vorher Rücksprache mit dem Hersteller halten.

3.3.2 wasser und Äthylenglykol

Bei der Installation in Außenbereichen oder in nicht beheizten Innenbereichen ist nicht auszuschließen, dass in den Stillstandperioden der Anlage, die in der Regel mit der kalten Jahreszeit zusammenfallen, das wasser einfriert.

Um diese Gefahr zu verringern:

- Den Kaltwassersatz mit geeigneten Frostschutzvorrichtungen ausstatten, die vom Hersteller als Optionen geliefert werden.
- Die Anlage über das entsprechende Ablassventil entleeren, falls eine längere Stillstandperiode vorgesehen ist.

Wassertemperatur am Auslauf [°C]	Äthylenglykol (% vol.)	Umgebungstemperatur
4	5	-2
2	10	-5
0	15	-7
-2	20	-10
-4	25	-12
-6	30	-15
-10	40	-20

- Zusätzlich eine entsprechende Menge Frostschutzmittel dem wasser im Kreis begeben (siehe Tabelle).

3.3.3 Expansionsgefäß

Gleicht Druck, - Temperaturschwankungen im Wasserkreis aus Um eine Schädigung der Einheit oder des Wasserkreises zu verhindern, empfiehlt sich die Installation eines Expansionsgefäßes mit geeigneter Kapazität.

Das Expansionsgefäß muss saugseitig zur Pumpe auf dem hinteren Anschluss des Tanks installiert werden.

Für die Berechnung des Mindestvolumens des an einem geschlossenen Kreis einzusetzenden Expansionsgefäßes kann folgende Formel verwendet werden:

$$V=2 \times V_{tot} \times (P_{t \min} - P_{t \max})$$

wobei

V_{tot}= Gesamtvolumen des Kreises (in Liter)

P_{t min}/max = spezifisches Gewicht bei Mindest-/Höchsttemperatur, die vom wasser erreicht werden kann [kg/dm³].

Bezüglich der Werte des spezifischen Gewichts je nach vorliegender Temperatur und Glykol-Prozentanteil ist die Tabelle einzusehen.

% Glykol	Temperatur [°C]						
	-10	0	10	20	30	40	50
0%	1.0024	1.0008	0.9988	0.9964	0.9936	0.9905	0.9869
10%	1.0177	1.0155	1.0130	1.0101	1.0067	1.0030	0.9989
20%	1.0330	1.0303	1.0272	1.0237	1.0199	1.0156	1.0110
30%	1.0483	1.0450	1.0414	1.0374	1.0330	1.0282	1.0230
40%	1.0636	1.0594	1.0525	1.0511	1.0461	1.0408	1.0350

⚠ Achtung: Beim Einfüllen auf die Angaben zur Füllung des Expansionsgefäßes achten.

Wenn die Umgebungslufttemperatur am Kühler weniger als -10 °C beträgt, müssen Sie das Ausdehnungsgefäß in eine geschützte Umgebung in der Nähe der Wasserrücklaufseite des Kühlers bringen. Sicherheitsventil und Entlüftungsventil müssen am Chiller verbleiben.

3.4 Stromkreis

3.4.1 Kontrollen und Anschluss

⚠ Vor jeder Arbeit an elektrischen Bauteilen unbedingt die Stromversorgung unterbrechen. Alle elektrischen Anschlüsse müssen den Anforderungen der einschlägigen lokalen Vorschriften des Installationsorts genügen.

Vorabkontrollen

- Die Werte für Spannung und Frequenz des Netzes müssen den Angaben auf dem Typenschild des Kaltwassersatzes entsprechen. Die Versorgungsspannung darf auch nicht kurzfristig außerhalb des im Schaltplan aufgeführten Toleranzbereichs liegen, der, falls nicht anders angegeben, +/- 10 % für die Spannung und +/- 1 % für die Frequenz beträgt.
- Die Spannung muss symmetrisch sein (d.h. Entsprechung untereinander der effektiven Werte der Spannungen und der Phasenwinkel zwischen aufeinanderfolgenden Phasen). Die zugelassene Abweichung zwischen den Spannungswerten darf maximal 2 % betragen.

Anschluss

- Die elektrische Versorgung der Kaltwassersätze wird mit einem 4-Leiter-Kabel, 3 Polig + Erde, ohne Neutralleiter, hergestellt. Bezüglich des Kabel-Mindestquerschnitts siehe Abschnitt 7.
- Das Kabel durch die Kabelschelle am rückseitigen Paneel der Einheit führen und den Phasen sowie den Neutralleiter an die Klemmen des Haupttrennschalters (QS), die Erde dagegen an die vorgesehene Erdungsklemme (PE) anschließen.
- Sicherstellen, dass am Anfang des Versorgungskabels eine Schutzvorrichtung gegen direkte Kontakte von mindestens IP2X oder IPXXB eingerichtet wird.
- An der elektrischen Versorgungsleitung des Kaltwassersatzes ist ein Fehlerstrom-Leitungsschutzschalter von (RCCB - IDn = 0.3A) mit der im entsprechenden Schaltplan angegebenen Stromfestigkeit zu installieren, der über eine geeignete Trennschaltleistung bezüglich des Kurzschlussstroms im Aufstellungsbereich der Einheit verfügt.
Der Nennstrom „In“ des Schutzschalters muss FLA entsprechen und die Auslösekennlinie muss vom Typ D sein.
- Maximaler Netzimpedanzwert = 0.274 Ohm.

Nachfolgende Kontrollen

Sicherstellen, dass die Einheit und dazugehörigen Steuereinrichtungen geerdet werden und gegen Kurzschluss und/oder Überlasten geschützt sind.

⚠ Sicherstellen, dass die Einheit und dazugehörigen Steuereinrichtungen geerdet werden und gegen Kurzschluss und/oder Überlasten geschützt sind.

⚠ Es liegt in der Verantwortung des Installateurs, die vorgeschriebenen Mindestprüfungen durchzuführen, um eine ordnungsgemäße elektrische Installation gemäß den örtlichen Vorschriften und abgestimmt auf das entsprechende Erdungssystem sicherzustellen. Hierbei sind auch die spezifischen Anforderungen für isolierte Neutralleiter-Systeme (IT) einzuhalten.

3.4.2 Allgemeiner Alarm

Alle Kaltwassersätze sind mit einer Alarm-Signalvorrichtung versehen (siehe Schaltplan), die aus einem freien Wechselkontakt an der Klemmenleiste besteht: Dies ermöglicht den Anschluss eines zentralisierten externen Alarms, der akustisch, sichtbar oder in einer Logik eingefügt, z.B. SPS, ausgeführt werden kann.

3.4.3 ON/OFF-Fernsteuerung

Alle Kaltwassersätze können über eine Fernsteuerung ein- und ausgeschaltet werden. (siehe Abschnitt 7.3)

- Um das Remote-Rif zu aktivieren. n.16387
- Als Führungsgröße EIN/AUS Rif.n.8996

Hinweis: „Sup“ und „Re“ nicht zusammen aktivieren.

Für den Anschluss des externen ON-OFF-Kontaktes siehe Schaltplan. (siehe Abschnitt 7.).

3.5 Wassergekühlte Version (W)

Die Chiller in der Version mit wassergekühltem Kondensator benötigen einen Wasserkreislauf, der Kaltwasser zum Kondensator leitet.

Der Chiller in Wasserversion ist mit einem Druckwächterventil am Einlass des Kondensators ausgestattet, das die Aufgabe hat, den Wasserdurchfluss so zu regulieren, dass immer eine optimale Kondensierung erzielt wird.

Vorabkontrollen

Erfolgt die Wasserversorgung des Kondensators in einem geschlossenen Kreislauf, müssen alle für den Hauptwasserkreis angegebenen Vorabkontrollen durchgeführt werden (Abschn. 3.3.1).

Anschluss

- Der Kondenswasserkreis sollte mit Absperrventilen ausgestattet werden, um die Maschine bei Wartungsarbeiten abschalten zu können.
- Die Vor-/Rücklaufleitungen des Wassers an die entsprechenden Verbindungsstutzen auf der Rückseite der Einheit anschließen.
- Fließt das Kondenswasser in einem offenen Kreislauf, ist es ratsam, den Kreis mit einem Filter im Kondensatoreinlass auszustatten, um die Gefahr der Verschmutzung der Oberflächen zu begrenzen.
- Beim geschlossenen Kreislauf überprüfen, ob er ordnungsgemäß mit Wasser gefüllt und entlüftet ist.

4 Steuerung

4.1 Bedienkonsole



- Taste PFEIL NACH OBEN: drücken, um den Wert eines ausgewählten editierbaren Parameters zu erhöhen.
- Taste PFEIL NACH UNTEN: drücken, um den Wert eines ausgewählten editierbaren Parameters zu senken.
- ESC-Taste: zum Verlassen ohne Speichern; kehrt zur vorherigen Ebene zurück; **5 s LANG GE-DRÜCKT HALTEN. ALARM-RESET.**
- SET-TASTE: zum Verlassen und Speichern/Bestätigen des Werts; gehen Sie zur nächsten Ebene; öffnen Sie das Einstellungs-Menü (SET); **5 s LANG GEDRÜCKT HALTEN. KÜHLER STARTEN.**

4.2 Bedeutung von Symbolen

Symbol	Symbolstatus	Funktion	Symbol	Symbolstatus	Funktion
	Leuchtet	Kompressor EIN		Leuchtet	Temperaturwert
	Blinkt	Kompressor Stand-by		Leuchtet	Druckventil
	Aus	Kompressor AUS			Leuchtet
	Leuchtet	Alarm aktiv		Leuchtet	Frostschutzheizung EIN
	Blinkt	Warnung oder Alarm rücksetzbar		Aus	Frostschutzheizung AUS
	Aus	Kein Alarm			Leuchtet
	Leuchtet	Pumpe 1 EIN	Aus		Kurbelgehäuseheizung AUS Kompressor 1
	Aus	Pumpe 1 AUS		Leuchtet	Kurbelgehäuseheizung EIN Kompressor 2 (nicht vorhanden)
	Leuchtet	Pumpe 2 EIN (nicht vorhanden)		Aus	Kurbelgehäuseheizung AUS Kompressor 2 (nicht vorhanden)
	Aus	Pumpe 2 AUS (nicht vorhanden)			

4.3 So starten Sie den Kühler

1. Schließen Sie die Maschine an die Stromversorgung an; drehen Sie dazu den Haupttrennschalter QS auf ON (EIN).
2. Drücken Sie die Taste "set" zum Starten.
3. Stellen Sie die gewünschte Temperatur am Controller ein. (Abschn. 4.5.1)

Phasenmonitor

Sollte beim Einschalten der Alarm „E r 3“ am Display erscheinen, muss das Drehfeld der Zuleitung geändert werden.

4.3.1 Einstellungen bei der Inbetriebnahme

1. Temperatureinstellung, siehe Abschnitt 4.5.
2. Regulierung der Pumpe Prüfen Sie die Pumpe auf korrekten Betrieb mit dem Druckmessgerät (P1 und P0 lesen) und prüfen Sie die Druckbegrenzungswerte (Pmax und Pmin), die auf der Pumpen-Datenplakette angezeigt sind.
 P1 = Druck bei INGESCHALT. PUMPE (ON)
 P0 = Druck bei AUSGESCHALT. PUMPE (OFF)
 $Pmin < (P1-P0) < Pmax$
 - Beispiel 1.
 Bedingungen:
 geschlossener Stromkreis, Druck P0 = 2 bar
 Werte auf der Pumpen-Datenplakette: Pmin 1 bar/ Pmax 3 bar
 Ventilauslass einstellen auf einen Druck von 3 bar < P1 < 5 bar
 - Beispiel 2.
 Bedingungen:
 offener Stromkreis, Druck P0 = 0 bar
 Werte auf der Pumpen-Datenplakette: Pmin 1 bar/ Pmax 3 bar
 Ventilauslass einstellen auf einen Druck von 1 bar < P1 < 3 bar
3. Prüfen Sie die Pumpe auf korrekten Betrieb ähnlich wie unter normalen Betriebsbedingungen. Prüfen Sie auch, dass die Amperezahl der Pumpe innerhalb der Grenzwerte auf der Datenplakette liegt.
4. Schalten Sie den Kühler aus und fahren Sie mit dem Auffüllen der Hydraulikeinheit zu der „EINGESTELLTEN“ („SET“) Temperatur fort.
5. Prüfen Sie, dass die Temperatur des „behandelten“ Wasser nicht unter 5 °C fällt und dass auch die Umgebungstemperatur, in welcher der Hydraulikkreis betrieben wird, nicht unter 5 °C fällt. Sinkt die Temperatur zu stark ab, geben Sie die entsprechende Menge Glykol wie in Abschnitt 3.3.2 erläutert dazu

ACHTUNG! Vor dem Einschalten der Kältemaschinenpumpe das (vom Kunden zu installierende) Wasserauslassventil schließen.

Das (vom Kunden zu installierende) Einlassventil immer geöffnet lassen.

Beim Einschalten der Pumpe langsam das Wasserauslassventil der Kältemaschine öffnen und die Durchflussmenge wie unter Punkt 4.3.1 beschrieben regulieren.

4.3.2 Beginnend mit Hochtemperaturwasser

Bei hohen Wassertemperaturen (z. B. 30–35 °C) schließen Sie das Absperrventil (kundendienst) am Kühlerausgang schrittweise (aber nicht vollständig, etwa zwei Drittel!), um den Wasserdurchfluss durch das Gerät zu reduzieren. Öffnen Sie das Ventil schrittweise, sobald die Wassertemperatur auf den Betriebswert gesunken ist.

Wichtig: In diesem Zustand können mehrere Hochdruckalarme auftreten, die manuell zurückgesetzt

werden müssen.

Wichtig: Diese Einstellung hilft auch, Wasserschläge entlang der Rohrleitungen aufgrund von Luftschlägen im Kreislauf zu vermeiden (Luftschläge müssen durch bauseits bereitzustellende Entlüftungsventile an den höchsten Punkten des Hydraulikkreislaufs beseitigt werden).

4.4 So stoppen Sie den Kühler

Wird der Betrieb des Kühlers nicht mehr erforderlich, schalten Sie ihn wie folgt ab: Drücken Sie die Taste "set" (5 sec.).

Schalten Sie den Hauptschalter QS nicht aus, damit gewährleistet ist, dass alle Frostschutzvorrichtungen weiterhin mit Strom versorgt werden.

4.5 Parametereinstellungen

Allgemeines

Es gibt zwei Schutzebenen für Parameter:

- a) Direkt User-(U): mit sofortigem Zugriff, **Vom Benutzer veränderbar**;
- b) Passwortgeschützt Service-(S): Passwort für Zugriff erforderlich, **(Nicht ändern)**.

4.5.1 Kühlerparameter (CF9)

PARAMETER	CODE	TYP	STANDARD
Einheit der Messung.	R1	U	OFF
Alarmrelais-Management	CFJ1	U	0
Standardparameter wiederherstellen	dEF	U	OFF
Aktivierung Ein/Aus per Fernsteuerung	R7	U	0
Software-Version	UEr	U	1.70
Adresse der Einheit	CF30	U	1
Baudrate	CF31	U	3
Modbus-Protokoll	CF32	U	1
Aktivierung Überwachung ein/aus	SUP	U	OFF
Aktivierung dynamischer Sollwert	Er d	U	OFF

4.5.2 Temperaturregelung (CFP)

PARAMETER	CODE	TYP	STANDARD
Temperaturregelung Sollwert (Standard)	SEt	U	13.0
Temperaturregelung Sollwert (Präzisionssteuerung)	SEt	U	20.0
Temperaturregelungsdifferential (in der Konfiguration „Präzisionssteuerung“ NICHT vorhanden)	dIF1	U	4.0

4.5.3 Wartungsparameter (Mnt)

PARAMETER	CODE	TYP	STANDARD
Betriebsstunden des Geräts	UH	U	-
Betriebsstunden des Geräts (X1000)	UHL	U	-
Teil-Betriebsstunden des Geräts	UPH	U	-

PARAMETER	CODE	TYP	STANDARD
Teil-Betriebsstunden des Geräts (X1000)	UPHL	U	-
Betriebsstunden Kompressor 1	CIH	U	-
Betriebsstunden Kompressor 1 (x1000)	CIHL	U	-

4.5.4 Sondenparameter (bt 1, bt2)

Sonde (bt 1)

PARAMETER	CODE	TYP	STANDARD
Temperaturalarm – zu hoch (Wasser)	HR1	U	50

Sonde (bt2)

PARAMETER	CODE	TYP	STANDARD
Temperaturalarm – zu hoch (Wasser)	HR2	U	50

4.5.5 Alarm-Protokoll (ALH 1)

PARAMETER	CODE	TYP	STANDARD
Alarmnummer	HYSP	U	-
Siehe Alarmcode	HYSC	U	-
Siehe Tag und Monat des Alarms	HYSD	U	-
Siehe Stunde und Minuten des Alarms	HYSE	U	-
bt1 Temperatur zur Zeit des Alarms	HY51	U	-
bt2 Temperatur zur Zeit des Alarms	HY52	U	-
SET Betriebszustand zur Zeit des Alarms	HY53	U	-

4.6 Parameter ändern (User)

4.6.1 Kühlerparameter „CF9“

Einheit der Messung.

<p>Schalten Sie den Kühler mit dem Haupt-Trennschalter QS auf „ON“ und warten Sie die Anzeige „OFF“ im Display ab.</p> <p>Drücken Sie gleichzeitig die Tasten „esc“ und „set“, um in Parameter „U“ zu gelangen.</p>	
<p>Parameter „PAR“ wird angezeigt.</p> <p>Drücken Sie die Taste „set“ zum Aufrufen.</p>	
<p>Parameter „CF9“ wird angezeigt.</p> <p>Drücken Sie die Taste „set“ zum Aufrufen.</p>	
<p>Parameter „A1“ wird angezeigt.</p> <p>Drücken Sie die Taste „set“ zum Aufrufen.</p>	
<p>Der Standardwert ist „OFF“ = °C</p> <p>Verwenden Sie die Tasten „>>“ und „<<“, um die Maßeinheit auszuwählen.</p> <p>OFF: Temperatur = °C, Celsius; Druck = bar; ON: Temperatur = °F, Fahrenheit; Druck = psi</p>	
<p>Drücken Sie die Taste „set“ zum Bestätigen.</p>	
<p>Die Anzeige kehrt automatisch zu „A1“ zurück.</p> <p>Der Parameter ist nun gespeichert.</p> <p>Drücken Sie zum Verlassen dreimal die Taste „esc“.</p>	

Alarm-Management

<p>Schalten Sie den Kühler mit dem Haupt-Trennschalter QS auf „ON“ und warten Sie die Anzeige „OFF“ im Display ab.</p> <p>Drücken Sie gleichzeitig die Tasten „esc“ und „set“, um in Parameter „U“ zu gelangen.</p>	
<p>Parameter „PAR“ wird angezeigt.</p> <p>Drücken Sie die Taste „set“ zum Aufrufen.</p>	
<p>Parameter „CF9“ wird angezeigt.</p> <p>Drücken Sie die Taste „set“ zum Aufrufen.</p>	
<p>Parameter „A1“ wird angezeigt.</p> <p>Verwenden Sie die Tasten „>>“ und „<<“, um den Parameter „CFJ1“ auszuwählen.</p>	
<p>Drücken Sie die Taste „set“ zum Aufrufen.</p>	
<p>Der Standardwert ist „0“.</p> <p>Verwenden Sie die Tasten „>>“ und „<<“, um das Alarmrelais-Management auszuwählen (Par. 4.5.1 – Tab.1)</p>	
<p>Drücken Sie die Taste „set“ zum Bestätigen.</p>	
<p>Die Anzeige kehrt automatisch zu „CFJ1“ zurück.</p> <p>Der Parameter ist nun gespeichert.</p> <p>Drücken Sie zum Verlassen dreimal die Taste „esc“.</p>	

Tab.1 Alarmrelais-Management (CFJ1.)

0	Relais normalerweise deaktiviert, wird durch einen Alarm aktiviert.
1	Relais normalerweise aktiviert (auch bei ausgeschalteter Steuerung (OFF)), wird durch einen Alarm deaktiviert.
2	Relais normalerweise aktiviert (nur bei eingeschalteter Steuerung (ON)), wird durch einen Alarm oder bei ausgeschalteter Steuerung deaktiviert.

Standardparameter

<p>Schalten Sie den Kühler mit dem Haupt-Trennschalter QS auf „ON“ und warten Sie die Anzeige „OFF“ im Display ab.</p> <p>Drücken Sie gleichzeitig die Tasten „esc“ und „set“, um in Parameter „U“ zu gelangen.</p>	
<p>Parameter „PRr“ wird angezeigt.</p> <p>Drücken Sie die Taste „set“ zum Aufrufen.</p>	
<p>Parameter „CF9“ wird angezeigt.</p> <p>Drücken Sie die Taste „set“ zum Aufrufen.</p>	
<p>Parameter „A i“ wird angezeigt.</p> <p>Verwenden Sie die Tasten „>>“ und „<<“, um den Parameter „dEF“ auszuwählen.</p>	
<p>Drücken Sie die Taste „set“ zum Aufrufen.</p>	
<p>Der Standardwert ist „OFF“.</p> <p>Verwenden Sie die Tasten „>>“ und „<<“, um von „OFF“ zu „On“ zu wechseln.</p>	
<p>Drücken Sie die Taste „set“ zum Bestätigen.</p>	
<p>Keihen Sie nach einigen Sekunden zu „OFF“ zurück.</p> <p>Die Parameter wurden automatisch zurückgesetzt.</p> <p>Drücken Sie zum Verlassen dreimal die Taste „esc“.</p>	

Fernsteuerung ON/OFF

<p>Schalten Sie den Kühler mit dem Haupt-Trennschalter QS auf „ON“ und warten Sie die Anzeige „OFF“ im Display ab.</p> <p>Drücken Sie gleichzeitig die Tasten „esc“ und „set“, um in Parameter „U“ zu gelangen.</p>	
<p>Parameter „PRr“ wird angezeigt.</p> <p>Drücken Sie die Taste „set“ zum Aufrufen.</p>	
<p>Parameter „CF9“ wird angezeigt.</p> <p>Drücken Sie die Taste „set“ zum Aufrufen.</p>	
<p>Parameter „A i“ wird angezeigt.</p> <p>Verwenden Sie die Tasten „>>“ und „<<“, um den Parameter „A7“ auszuwählen.</p>	
<p>Drücken Sie die Taste „set“ zum Aufrufen.</p>	
<p>Der Standardwert ist „0“.</p> <p>Verwenden Sie die Tasten „>>“ und „<<“, um den Modus auszuwählen: (Par. 4.5.1 – Tab. 2)</p>	
<p>Drücken Sie die Taste „set“ zum Bestätigen.</p>	
<p>Die Anzeige kehrt automatisch zu „A7“ zurück.</p> <p>Der Parameter ist nun gespeichert.</p> <p>Drücken Sie zum Verlassen dreimal die Taste „esc“.</p>	

Tab. 2 Fernsteuerung Ein/Aus-Modus (A7)

0	Fernsteuerung Ein/Aus deaktiviert
1	Fernsteuerung Ein/Aus aktiviert mit lokalem Ein/Aus. Wenn der Strom ausfällt oder der Hauptschalter ausgeschaltet ist, muss der Kühler nach der Rückkehr der Stromversorgung lokal neu gestartet werden.
2	Nur Fernsteuerung Ein/Aus, lokales Ein/Aus deaktiviert

Software-Version (schreibgeschützt)

<p>Schalten Sie den Kühler mit dem Haupt-Trennschalter QS auf „ON“ und warten Sie die Anzeige „OFF“ im Display ab.</p> <p>Drücken Sie gleichzeitig die Tasten „esc“ und „set“, um in Parameter „U“ zu gelangen.</p>	
<p>Parameter „PAr“ wird angezeigt.</p> <p>Drücken Sie die Taste „set“ zum Aufrufen.</p>	
<p>Parameter „CF9“ wird angezeigt.</p> <p>Drücken Sie die Taste „set“ zum Aufrufen.</p>	
<p>Parameter „R i“ wird angezeigt.</p> <p>Verwenden Sie die Tasten „>>“ und „<<“, um den Parameter „UEr“ auszuwählen.</p>	
<p>Drücken Sie die Taste „set“ zum Aufrufen.</p>	
<p>Die Software-Version wird angezeigt.</p>	
<p>Drücken Sie zum Verlassen dreimal die Taste „esc“.</p>	

Überwachung aktivieren

<p>Schalten Sie den Kühler mit dem Haupt-Trennschalter QS auf „ON“ und warten Sie die Anzeige „OFF“ im Display ab.</p> <p>Drücken Sie gleichzeitig die Tasten „esc“ und „set“, um in Parameter „U“ zu gelangen.</p>	
<p>Parameter „PAr“ wird angezeigt.</p> <p>Drücken Sie die Taste „set“ zum Aufrufen.</p>	
<p>Parameter „CF9“ wird angezeigt.</p> <p>Drücken Sie die Taste „set“ zum Aufrufen.</p>	
<p>Parameter „R i“ wird angezeigt.</p> <p>Verwenden Sie die Tasten „>>“ und „<<“, um den Parameter „SUP“ auszuwählen.</p>	
<p>Drücken Sie die Taste „set“ zum Aufrufen.</p>	
<p>Der Standardwert ist „OFF“.</p> <p>Verwenden Sie zum Ändern die Tasten „>>“ und „<<“.</p>	
<p>Drücken Sie die Taste „set“ zum Bestätigen.</p>	
<p>Der Parameter ist nun gespeichert.</p> <p>Drücken Sie zum Verlassen dreimal die Taste „esc“.</p>	

Modbus (Adresse)

<p>Schalten Sie den Kühler mit dem Haupt-Trennschalter QS auf „ON“ und warten Sie die Anzeige „OFF“ im Display ab.</p> <p>Drücken Sie gleichzeitig die Tasten „esc“ und „set“, um in Parameter „U“ zu gelangen.</p>	
<p>Parameter „PAr“ wird angezeigt.</p> <p>Drücken Sie die Taste „set“ zum Aufrufen.</p>	
<p>Parameter „CF9“ wird angezeigt.</p> <p>Drücken Sie die Taste „set“ zum Aufrufen.</p>	
<p>Parameter „A i“ wird angezeigt.</p> <p>Verwenden Sie die Tasten „>“ und „<“, um den Parameter „CF30“ auszuwählen.</p>	
<p>Drücken Sie die Taste „set“ zum Aufrufen.</p>	
<p>Der Standardwert ist „1“.</p> <p>Verwenden Sie die Tasten „>“ und „<“, um die Adresse zu ändern.</p>	
<p>Drücken Sie die Taste „set“ zum Bestätigen.</p>	
<p>Der Parameter ist nun gespeichert.</p> <p>Drücken Sie zum Verlassen dreimal die Taste „esc“.</p>	

Modbus (Protokoll)

<p>Schalten Sie den Kühler mit dem Haupt-Trennschalter QS auf „ON“ und warten Sie die Anzeige „OFF“ im Display ab.</p> <p>Drücken Sie gleichzeitig die Tasten „esc“ und „set“, um in Parameter „U“ zu gelangen.</p>	
<p>Parameter „PAr“ wird angezeigt.</p> <p>Drücken Sie die Taste „set“ zum Aufrufen.</p>	
<p>Parameter „CF9“ wird angezeigt.</p> <p>Drücken Sie die Taste „set“ zum Aufrufen.</p>	
<p>Parameter „A i“ wird angezeigt.</p> <p>Verwenden Sie die Tasten „>“ und „<“, um den Parameter „CF31“ auszuwählen.</p>	
<p>Drücken Sie die Taste „set“ zum Aufrufen.</p>	
<p>Der Standardwert ist „1“.</p> <p>Verwenden Sie die Tasten „>“ und „<“, um das Protokoll zu ändern. (Par. 4.5.1 – Tab. 3)</p>	
<p>Drücken Sie die Taste „set“ zum Bestätigen.</p>	
<p>Der Parameter ist nun gespeichert.</p> <p>Drücken Sie zum Verlassen dreimal die Taste „esc“.</p>	

Tab. 3 Protokoll-Modbus (optional) (CF3 i)

1	EVEN (GERADE)	2	NONE (KEIN)	3	ODD (UNGERADE)
---	---------------	---	-------------	---	----------------

Modbus (Baudrate)

<p>Schalten Sie den Kühler mit dem Haupt-Trennschalter QS auf „ON“ und warten Sie die Anzeige „OFF“ im Display ab.</p> <p>Drücken Sie gleichzeitig die Tasten „esc“ und „set“, um in Parameter „U“ zu gelangen.</p>	
<p>Parameter „PAR“ wird angezeigt.</p> <p>Drücken Sie die Taste „set“ zum Aufrufen.</p>	
<p>Parameter „CF9“ wird angezeigt.</p> <p>Drücken Sie die Taste „set“ zum Aufrufen.</p>	
<p>Parameter „A i“ wird angezeigt.</p> <p>Verwenden Sie die Tasten „>>“ und „<<“, um den Parameter „CF32“ auszuwählen.</p>	
<p>Drücken Sie die Taste „set“ zum Aufrufen.</p>	
<p>Der Standardwert ist „3“.</p> <p>Verwenden Sie die Tasten „>>“ und „<<“, um die Baudrate zu ändern. (Par. 4.5.1 - Tab. 4)</p>	
<p>Drücken Sie die Taste „set“ zum Bestätigen.</p>	
<p>Der Parameter ist nun gespeichert.</p> <p>Drücken Sie zum Verlassen dreimal die Taste „esc“.</p>	

Tab. 4 Baudrate (optional) (CF32)

1	2400	3	9600	5	38400	7	115200
2	4800	4	19200	6	57600		

Hinweis: Wenn Sie die MODBUS-Parameter ändern, müssen Sie den Kühler aus- und wieder einschalten, um die neuen Parameter zu validieren.





ERD aktivieren

<p>Schalten Sie den Kühler mit dem Haupt-Trennschalter QS auf „ON“ und warten Sie die Anzeige „OFF“ im Display ab.</p> <p>Drücken Sie gleichzeitig die Tasten „esc“ und „set“, um in Parameter „U“ zu gelangen.</p>	
<p>Parameter „PAR“ wird angezeigt.</p> <p>Drücken Sie die Taste „set“ zum Aufrufen.</p>	
<p>Parameter „CF9“ wird angezeigt.</p> <p>Drücken Sie die Taste „set“ zum Aufrufen.</p>	
<p>Parameter „A i“ wird angezeigt.</p> <p>Verwenden Sie die Tasten „>>“ und „<<“, um den Parameter „Er d“ auszuwählen.</p>	
<p>Drücken Sie die Taste „set“ zum Aufrufen.</p>	
<p>Der Standardwert ist „OFF“.</p> <p>Verwenden Sie zum Ändern die Tasten „>>“ und „<<“.</p>	
<p>Drücken Sie die Taste „set“ zum Bestätigen.</p>	
<p>Der Parameter ist nun gespeichert.</p> <p>Drücken Sie zum Verlassen dreimal die Taste „esc“.</p>	

Mit aktiviertem ERD-Parameter: Die Solltemperatur des Wassers ändert sich mit der Umgebungstemperatur. Die Funktion ist nur aktiv, wenn die Temperaturpräzisionssteuerung deaktiviert ist (CPT=OFF).





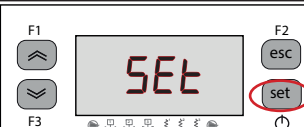
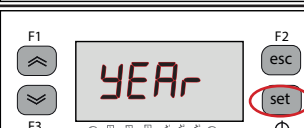
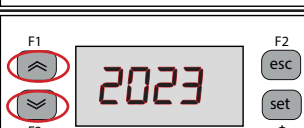
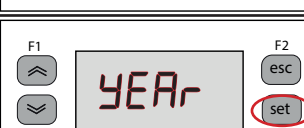



4.6.2 Temperaturregelung „CNP“

Temperaturregelungseinstellung

Schalten Sie den Kühler mit dem Haupt-Trennschalter QS auf „ON“ und warten Sie die Anzeige „OFF“ im Display ab. Drücken Sie gleichzeitig die Tasten „esc“ und „set“, um in Parameter „U“ zu gelangen.	
Parameter „PAR“ wird angezeigt. Drücken Sie die Taste „set“ zum Aufrufen.	
Parameter „CF9“ wird angezeigt. Verwenden Sie die Tasten „>>“ und „<<“, um den Parameter „CNP“ auszuwählen.	
Drücken Sie die Taste „set“ zum Aufrufen.	
Parameter „SEt“ wird angezeigt. Drücken Sie die Taste „set“ zum Aufrufen.	
Der Standardwert ist „13.0“. Verwenden Sie die Tasten „>>“ und „<<“, um den Wert zu ändern.	
Drücken Sie die Taste „set“ zum Bestätigen.	
Der Parameter ist nun gespeichert. Drücken Sie zum Verlassen dreimal die Taste „esc“.	

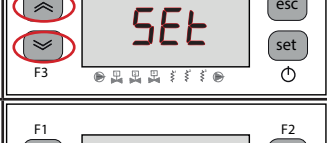
Wichtiger Hinweis: Eine Einstellung der Temperatur zwischen 1 °C und 5 °C muss von spezialisierten Technikern vorgenommen werden, die das spezifische Wartungshandbuch dieses Produkts verwenden müssen.

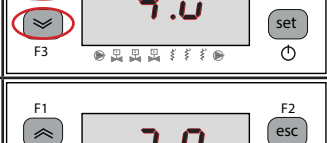
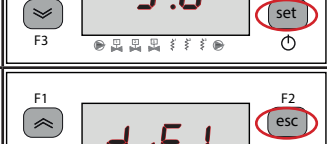
Temperaturdifferenzregelung

Schalten Sie den Kühler mit dem Haupt-Trennschalter QS auf „ON“ und warten Sie die Anzeige „OFF“ im Display ab. Drücken Sie gleichzeitig die Tasten „esc“ und „set“, um in Parameter „U“ zu gelangen.	
Parameter „PAR“ wird angezeigt. Drücken Sie die Taste „set“ zum Aufrufen.	
Parameter „CF9“ wird angezeigt. Verwenden Sie die Tasten „>>“ und „<<“, um den Parameter „CNP“ auszuwählen.	
Drücken Sie die Taste „set“ zum Aufrufen.	
Parameter „SEt“ wird angezeigt. Verwenden Sie die Tasten „>>“ und „<<“, um den Parameter „d i F I“ auszuwählen.	
Drücken Sie die Taste „set“ zum Aufrufen.	
Der Standardwert ist „4.0“. Verwenden Sie die Tasten „>>“ und „<<“, um den Wert zu ändern.	
Drücken Sie die Taste „set“ zum Bestätigen.	
Der Parameter ist nun gespeichert. Drücken Sie zum Verlassen dreimal die Taste „esc“.	

4.6.3 Sondenparameter „bt 1“

Sonde „bt 1“.

Schalten Sie den Kühler mit dem Haupt-Trennschalter QS auf „ON“ und warten Sie die Anzeige „OFF“ im Display ab. Drücken Sie gleichzeitig die Tasten „esc“ und „set“, um in Parameter „U“ zu gelangen.	
Parameter „PAR“ wird angezeigt. Drücken Sie die Taste „set“ zum Aufrufen.	
Parameter „CF9“ wird angezeigt. Verwenden Sie die Tasten „>>“ und „<<“, um den Parameter „bt 1“ auszuwählen.	
Drücken Sie die Taste „set“ zum Aufrufen.	
Parameter „HA 1“ wird angezeigt. Drücken Sie die Taste „set“ zum Aufrufen.	
Der Standardwert ist „60.0“. Verwenden Sie die Tasten „>>“ und „<<“, um den Wert zu ändern.	
Drücken Sie die Taste „set“ zum Bestätigen.	
Der Parameter ist nun gespeichert. Drücken Sie zum Verlassen dreimal die Taste „esc“.	

Dieselbe Sequenz für die Sonde „bt2“.

4.7 Visualisierung Sonden/ Lüfter/ Kompressor

Kühler in Betrieb. Berühren Sie die Schaltfläche „>>“, um die Sonden anzuzeigen.... <i>bt 1, bt 2, bt 3, bP 1.....</i>	
Wählen Sie die Sonde aus und warten Sie einige Sekunden. (z. B. BT2)	
Der Wert der Sonde bt 2 wird angezeigt.	
Es ist ratsam, immer zur Sonde bt 1 zurückzukehren.	

Beschreibung:

- bt 1 : Temperatursensor für Wasser am Auslauf**
- bt 2 : Temperatursensor Verdampfer**
- bt 3 : Temperatursensor Umgebungsluft**
- bt 10 : Temperatursensor Schalttafel (Option)**
- bP 1 : Transduktor Kreis 1**
- bP 2 : Transduktor Kreis 2 (vom Modell ICEP080)**

F... : Lüfterbetrieb:

- F... : Lüfter AUS
- F- : Lüfter 1 EIN, Lüfter 2,3 AUS: (2 = vom Modell ICEP022) (3 = vom Modell ICEP080)
- F-- : Lüfter 1 und 2 EIN, fan 3 AUS, (2 = vom Modell ICEP022) (3 = vom Modell ICEP080)
- F--- : Lüfter 1,2 und 3 EIN (vom Modell ICEP080)

CF... : Kompressorbetrieb:

- CF... : Kompressoren deaktiviert
- CF- : Kompressoren AUS
- CF- : Kompressor 1 EIN, Kompressor 2 AUS
- CF- : Kompressoren 1 und 2 EIN; (vom Modell ICEP055)
- CF- : mit blinkender „1“ Kompressor startbereit, Kompressor 2 AUS

4.8 Einstellung von Uhrzeit/Datum

<p>Schalten Sie den Kühler mit dem Haupt-Trennschalter QS auf „ON“ und warten Sie die Anzeige „OFF“ im Display ab.</p> <p>Drücken Sie gleichzeitig die Tasten „“ und „“, um in den Parameter „Datum/Uhrzeit“ zu gelangen.</p>	
<p>Parameter „FrEE“ wird angezeigt.</p> <p>Drücken Sie die Taste „set“ zum Aufrufen.</p>	
<p>Parameter „R1“ wird angezeigt.</p> <p>Verwenden Sie die Tasten „“ und „“, um den Parameter „CL“ auszuwählen.</p>	
<p>Drücken Sie die Taste „set“ zum Aufrufen.</p>	
<p>Parameter „HOUr“ wird angezeigt.</p> <p>Drücken Sie 5 Sekunden lang die Taste „set“.</p> <p>Jetzt blinkt der Parameter.</p>	
<p>Verwenden Sie die Tasten „“ und „“, um Datum, Uhrzeit oder Jahr zum Ändern auszuwählen.</p>	
<p>Drücken Sie die Taste „set“ zum Aufrufen.</p>	
<p>Verwenden Sie die Tasten „“ und „“, um den Wert zu ändern (z. B.: Jahr).</p>	
<p>Drücken Sie die Taste „set“ zum Bestätigen.</p>	

Verwenden Sie die Tasten „“ und „“, um einen anderen Wert zu ändern (z. B.: Datum).



Drücken Sie die Taste „esc“ zum Verlassen.
Der Parameter hört auf zu blinken.



Drücken Sie zum Verlassen gleichzeitig die Tasten „“ und „“.



**⚠ Der Speicher von „Uhrzeit/Datum“ hat eine maximale Dauer von drei Tagen, d. h. bleibt das Steuermodul länger als drei Tage ohne Stromversorgung, dann sind die internen Einstellungen für Stunde/Monat/Jahr verloren.
Stellen Sie die Uhrzeit beim ersten Starten der Maschine ein und immer dann, wenn es nötig ist.**

4.9 Alarm-Management

Bei Vorliegen eines Alarms werden oben links ein Alarmcode und ein Symbol angezeigt

 Kontinuierlich = Alarm vorhanden
Blinkend = Warnung aktiv / Alarm rücksetzbar

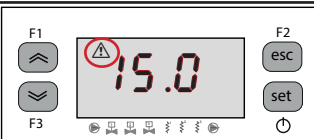

Drücken Sie die Taste „set“ zum Aufrufen.



Parameter „RLH“ wird angezeigt.

Verwenden Sie die Taste „<“, um den Parameter „RL“ auszuwählen.



Drücken Sie die Taste „set“ zum Aufrufen.



Der Alarmcode wird angezeigt: „Er04“.

Drücken Sie die Taste „>“, um zu prüfen, ob weitere Alarme vorhanden sind.

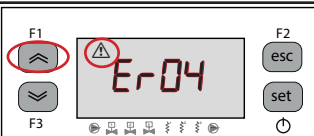

Beheben Sie den Fehler, bevor Sie den Reset durchführen. Sobald die Störung behoben ist, beginnt das Alarmsymbol zu blinken. Jetzt können Sie den Reset durchführen.

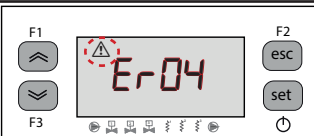



Drücken Sie die Taste „esc“, bis der Alarm erlischt.



Liste der Alarme/Warnungen

Code	Beschreibung	Aktion	Rücksetzen
Er01	Sensor bt1 ausgefallen oder defekt	Alarm	M
Er02	Sensor bt2 ausgefallen oder defekt	Alarm	M
Er03	Sensor bt3 ausgefallen oder defekt	Alarm	A
Er05	Sensor bt10 ausgefallen oder defekt	Alarm	A
Er06	Sensor bP1 ausgefallen oder defekt	Alarm	M
Er08	Hochdruckschalter Kreis 1	Alarm	M
Er09	Niederdruckschalter Kreis 1	Alarm	M
Er12	Temperatur bt1 zu hoch	Alarm	M
Er13	Temperatur bt1 zu niedrig	Alarm	A
Er14	Temperatur bt2 zu hoch	Alarm	M
Er15	Temperatur bt2 zu niedrig	Alarm	M
Er16	Temperatur bt3 zu hoch	Alarm	A
Er17	Temperatur bt3 zu niedrig	Alarm	A
Er18	Kompressor, thermischer Schutz 1	Alarm	M
Er20	Pumpe, thermischer Schutz 1	Alarm	M
Er22	Niedriger Wasserstand / Differenzdruckschalter	Alarm	M
Er23	Phasenüberwachung	Alarm	M
Er24	Ausdehnung gebrochen oder getrennt	Alarm	M
Er25	Kompressor 1, zu viele Betriebsstunden	Warnung	M
Er27	Zu viele Betriebsstunden des Geräts	Warnung	M
Er28	Uhrzeitspeicher	Warnung	A
Er29	Kühlerkonfiguration	Warnung	A

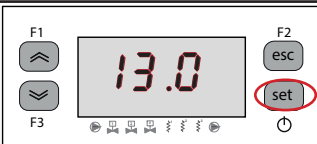

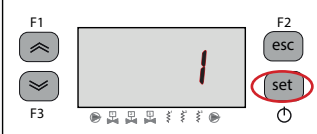

4.10 Alarm-Protokoll

Kühler in Betrieb. Berühren Sie die Schaltfläche „set“, um das Alarm-Protokoll anzuzeigen.	
Drücken Sie die Taste „set“ zum Aufrufen.	
Verwenden Sie die Tasten „>>“ und „<<“, um die Parameter anzuzeigen. (Par. 4.5.5)	
Drücken Sie die Taste „set“, um den Wert anzuzeigen.	

5 Wartung

- Die Einheit ist entsprechend ausgelegt, um einen kontinuierlichen Dauerbetrieb zu gewährleisten; die Betriebslebensdauer der jeweiligen Komponenten ist jedoch direkt von der ausgeführten Wartung abhängig.
-  Für die Anforderung von Serviceeingriffen oder Ersatzteilen sind die Angaben auf dem Typenschild an der Außenseite der Einheit zu notieren (Modell und Seriennummer) und dem Wartungsservice mitzuteilen. (www.polewr.com)

5.1 Allgemeine Hinweise

-  Vor jedem Wartungseingriff muss kontrolliert werden, dass das Gerät nicht mehr gespeist wird.
-  Stets Original-Ersatzteile des Herstellers verwenden; anderenfalls übernimmt der Hersteller keinerlei Haftung bei Fehlbetrieben der Einheit.
-  Bei Verlust von Kältemittel sind ausschließlich zertifizierte Kältetechniker zu kontaktieren.
-  Das Schrader-Ventil ist nur im Fall eines von der Norm abweichenden Betriebs der Einheit einzusetzen; anderenfalls werden Schäden infolge unkorrekter Kältemittelbefüllung nicht von der Garantie abgedeckt.

5.2 Kältemittel













Kältemittelbefüllung: Eventuelle Schäden infolge unkorrekter Kältemittelbefüllung durch nicht autorisierte Personen werden nicht von der Garantie abgedeckt. 

-  Das Gerät enthält vom Kyoto-Protokoll erfasste fluorierte Treibhausgase. Das Kältemittel R513A ist unter Temperatur- und Druck-Standardbedingungen ein farbloses Gas mit Zugehörigkeit zur SAFETY GROUP A1 - EN378 (Flüssigstoffgruppe 2 gemäß Druckgeräte-Richtlinie 2014/68/EU); GWP (Global Warming Potential) = 629.

-  In case of refrigerant leakage, air the room.

5.3 Wartungsprogramm

Für eine stets optimale Effizienz und Zuverlässigkeit des Chiller werden empfohlen:

Beschreibung der Wartungsarbeiten	Wartungszeitraum (unter Standardbetriebsbedingungen)				
	Arbeit	Täglich	6 Months	12 Months	36 Months
Kontrolle  Wartungsdienst 					
Kontrollieren, ob die Betriebsanzeige POWER ON leuchtet.					
Die Anzeigen der Bedientafel kontrollieren.					
Die Kondensatorrippen reinigen.					
Die Stromaufnahme prüfen.					
Die Anlage auf Kältemittelverluste kontrollieren.					
Die Wasser Sicherheitsventil reinigen und prüfen (falls vorhanden)*					
Die elektrische System der Maschine und die Schalttafel kontrollieren.**					
Die Temperaturfühler kontrollieren. Bei Bedarf auswechseln.				 	
Wartungsbausatz					

 Folgende Wartungskits sind lieferbar (siehe Abschnitt 7.):

- a) Service-kit: electrical kit; Kompressor-kit; Ventilator-kit; Verdampfer kit; Pumpe-kit; Wassertank-kit;
- b) Einzel Ersatzteile

*Um eine einwandfreie Funktion der Sicherheitsventile zu gewährleisten, müssen diese regelmäßig überprüft werden. Im Laufe der Zeit können sich Verunreinigungen in der Nähe des Ventilkugels ablagern. Aus diesem Grund muss der Sitz regelmäßig gespült werden. Zum Spülen wird das Ventil von Hand durch Drehen des Knopfes in Pfeilrichtung entleert.

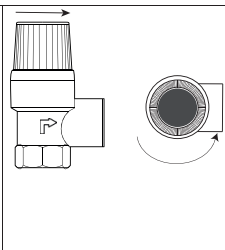



Wichtig: Nach Beendigung dieses Vorgangs ist sicherzustellen, dass der Betriebsdruck wieder hergestellt ist.

**** Im Rahmen der regelmäßigen Wartung müssen auch das elektrische System der Maschine und die Schalttafel gemäß den örtlichen Vorschriften überprüft werden. Darüber hinaus sollte nach Möglichkeit immer eine Sichtprüfung der Ausrüstung und der elektrischen Leiter durchgeführt werden. Ferner ist zu überprüfen, ob die Klemmen der Leistungskomponenten gemäß den im Schaltplan angegebenen Anzugsdrehmomenten festgezogen sind.**

5.4 Entsorgung

Kältemittel und Schmieröl, die im Kältekreis enthalten sind, müssen nach den einschlägigen Umweltschutznormen des jeweiligen Installationsorts aufgefangen und entsorgt werden. Das Auffangen des Kältemittels erfolgt vor der endgültigen Verschrottung des Geräts ((EU) Nr. 517/2014, Art. 8)..

	Recycling Entsorgung 
Struktur	Stahl/Expoxydharze/Polyester
Tank	Aluminium/Kupfer/Stahl
Rohre/Sammelleitungen	Kupfer/Aluminium/Kohlenstoffstahl
Isoliermaterial Rohre	Nitril-Gummi (NBR)
Verdichter	Stahl/Kupfer/Aluminium/Öl
Kondensator	Stahl/Kupfer/Aluminium
Pumpe	Stahl/ Gusseisen/Messing
Ventilator	Aluminium
Kältemittel	R513A
Ventile	Messing/Kupfer
Stromkabel	Kupfer/PVC

Geräte, die elektrische Komponenten enthalten, müssen gemäß den örtlichen und aktuellen Gesetzen getrennt mit Elektro- und Elektronikschrott entsorgt werden.



6 Störungssuche

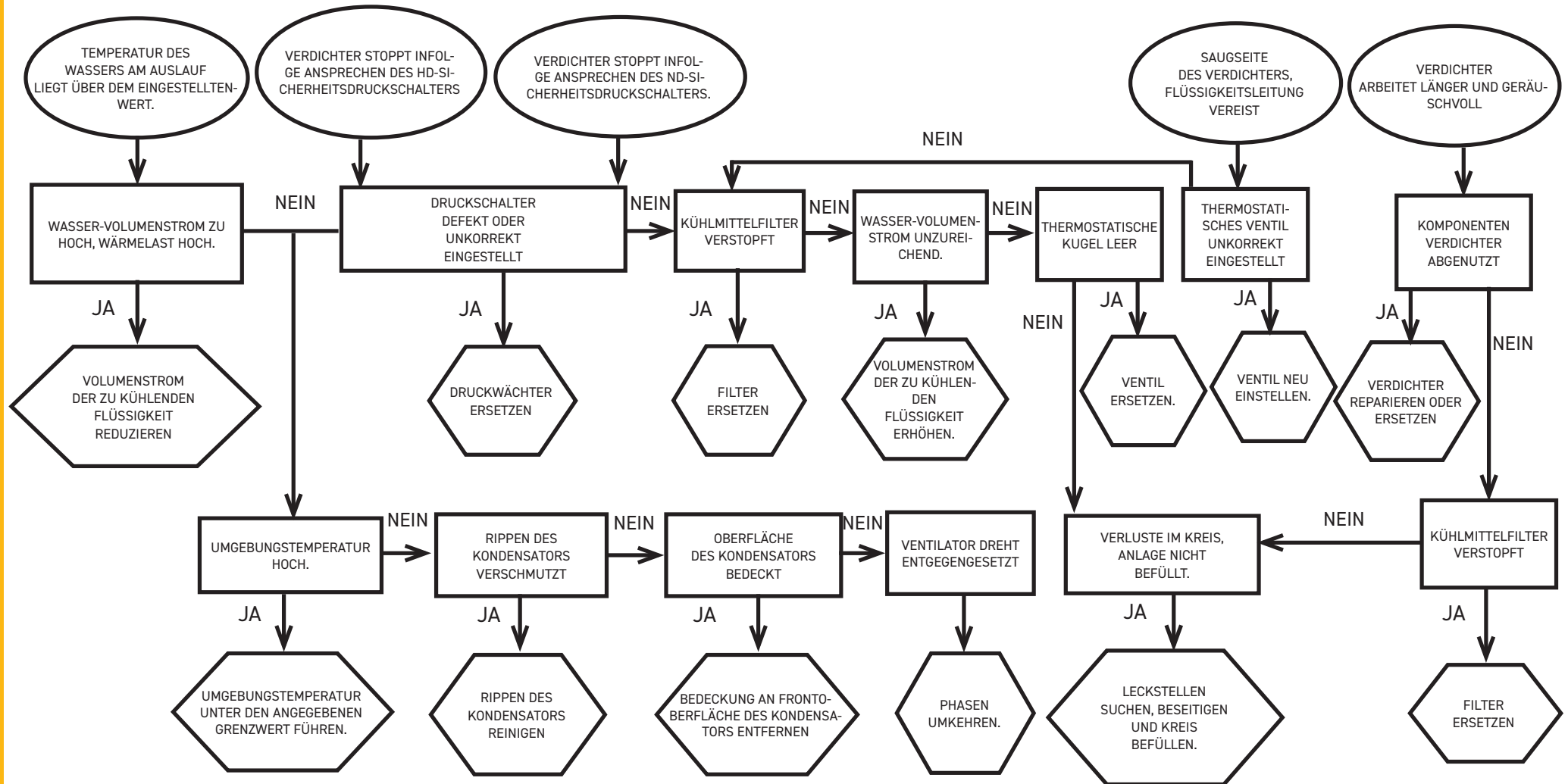
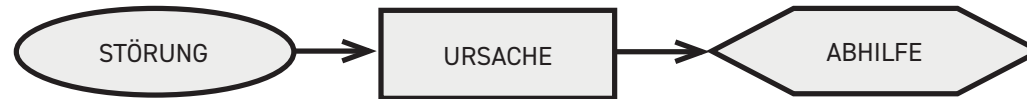

1 Segurança	2
1.1 Importância do manual	2
1.2 Sinais de aviso	2
1.3 Indicações de segurança.....	2
1.4 Riscos residuais.....	2
2 Introdução	3
2.1 Transporte	3
2.2 Movimentação	3
2.3 Inspeção.....	3
2.4 Armazenamento.....	3
3 Instalação	3
3.1 Espaço operativo.....	3
3.2 Versões.....	3
3.3 Circuito hidráulico.....	3
3.3.1 Controlos e ligação.....	3
3.3.2 Água e etileno glicol.....	4
3.3.3 Tanque de expansão.....	4
3.4 Circuito eléctrico.....	5
3.4.1 Controlos e ligações.....	5
3.4.2 Alarme general	5
3.4.3 ON/OFF por controlo remoto.....	5
3.5 Versão a água (W).....	5
4 Controlo	6
4.1 Painel de controlo	6
4.2 Significado dos símbolos.....	6
4.3 Ligar o refrigerador	6
4.3.1 Ajustes aquando da entrada em funcionamento	6
4.3.2 Começando com água a alta temperatura.....	6
4.4 Parar o refrigerado.....	7
4.5 Definições de parâmetros.....	7
4.5.1 Parâmetros do refrigerador (CF9).....	7
4.5.2 Controlo de temperatura (CNP)	7
4.5.3 Parâmetros de manutenção (MnE).....	7
4.5.4 Parâmetros da sonda (bE 1, bE2).....	7
4.5.5 Histórico de alarmes (RLH 1).....	7
4.6 Alterar parâmetros (User).....	8
4.6.1 Parâmetros do refrigerador "CF9"	8
4.6.2 Controlo de temperatura "CNP"	13
4.6.3 Parâmetro da sonda "bE 1".....	14
4.7 Visualização sonda/ ventilador/ compressor.....	14
4.8 Ajuste da hora/data.....	15
4.9 Gestão dos alarmes.....	16
4.10 Histórico de alarmes.....	17
5 Manutenção	17
5.1 Advertências gerais.....	17
5.2 Refrigerante	17
5.3 Programa de manutenção preventiva	18
5.4 Desmontagem	18

6 Localização de avarias

7 Anexo

7.1 Legenda
7.2 Esquema de instalação
7.3 Movimentação - Espaço operativo
7.4 Dados té cnicos
7.5 Dimensões
7.6 Lista de peças de substituição
7.7 Desenhos explodidos
7.8 Circuito frigorífico
7.9 Esquema eléctrico

1 Segurança

1.1 Importância do manual

- Conservar durante toda a vida útil da máquina.
- Ler o manual antes de qualquer operação.
- Está sujeito a modificações: para obter informações actualizadas, consultar a versão fornecida com a máquina.

1.2 Sinais de aviso



Instruções para evitar perigos para as pessoas.



Instruções a seguir para evitar danos no aparelho.





La présence d'un professionnel qualifié et agréé est exigée.





Estão presentes símbolos cujo significado é explicado no parágrafo 7.

1.3 Indicações de segurança

 Cada unidade possui um seccionador eléctrico que intervém em condições de segurança. Usar sempre este dispositivo para eliminar os perigos durante a manutenção.

 **O manual dirige-se ao utilizador final apenas para operações que podem ser efectuadas com os painéis fechados: operações instalação/ entrada em funcionamento/manutenção o que obriguem à abertura utilizando ferramentas devem ser efectuadas por pessoal especializado e qualificado.**

 **Apenas para instalação em locais não acessíveis ao público em geral, seja em local seguro com acesso restrito ou a um nível não inferior a 2,5 m ou em áreas seguras no telhado, a menos que tenham recebido supervisão ou instruções sobre a utilização do aparelho de uma pessoa responsável pela sua segurança.**



 A distância de instalação da parede e o espaço de funcionamento livre são indicados no parágrafo 7.3.

 **Atenção: respeitar a temperatura e pressão Mín./Máx. indicadas no par. 7.4, e a Gama de temperatura geral de funcionamento indicada no par. 7.2.**

 **Todas as unidades podem ser instaladas no exterior.**

 **Todas as conexões eléctricas devem ser efectuadas de acordo com as normas locais relativas ao sítio da instalação.**

 Não ultrapasse os limites de projecto indicados na placa de dados.

  Cabe ao utilizador evitar cargas distintas da pressão estática interna. Se houver o risco de acções sísmicas, a unidade deve ser devidamente protegida. Utilizar a unidade exclusivamente para uso profissional e para o fim para o qual foi concebida.

 Cabe ao utilizador analisar todos os aspectos da aplicação em que o produto é instalado, seguir todos as normas industriais de segurança aplicáveis e todas as prescrições relativas ao produto, contidas no manual de utilização e em qualquer documentação produzida e fornecida com a unidade. A alteração ou substituição de qualquer componente por parte de pessoal não autorizado e/ou a utilização incorrecta da unidade isentam o fabricante de qualquer responsabilidade e anulam a garantia. Declina-se qualquer responsabilidade presente e futura por danos a pessoas, objectos e na própria unidade, resultantes de negligência por parte dos operadores, do não cumprimento de todas as instruções apresentadas neste manual, da falta de aplicação das normas em vigor relativamente à segurança da instalação.

O fabricante não se responsabiliza por eventuais danos devidos a alterações e/ou modificações da embalagem.

É da responsabilidade do utilizador certificar-se de que as especificações fornecidas para a selecção da unidade ou dos seus componentes e/ou opções são exaustivas, com vista a uma utilização correcta ou razoavelmente previsível da própria unidade ou dos componentes.

 **ATENÇÃO: O fabricante reserva-se o direito de modificar as informações contidas no presente manual, sem incorrer na obrigação de avisá-las previamente.**

Para obter informações completas e actualizadas, recomenda-se ao utilizador de consultar o manual a bordo da unidade.

1.4 Riscos residuais

As operações de instalação, arranque, desactivação e manutenção da máquina devem ser taxativamente executadas conforme as indicações fornecidas na documentação técnica do aparelho e de modo a não gerar nenhuma situação de risco.

A tabela seguinte indica os riscos que não foi possível eliminar na fase de concepção..

parte considerada	risco residual	modo	precauções
bateria de troca de energia	pequenos cortes	contacto	evite o contacto, use luvas de protecção
grelha do ventilador e ventilador	lesões	inserção de objectos pontiagudos através da grelha enquanto o ventilador está a funcionar	não introduza objectos de nenhum tipo dentro da grelha dos ventiladores e não pouse objectos nas grelhas
interior da unidade: compressor e tubo de saída	queimaduras	contacto	evite o contacto, use luvas de protecção

parte considerada	risco residual	modo	precauções
interior da unidade: partes metálicas e cabos eléctricos	intoxicações, fulguração, queimaduras graves	defeito de isolamento dos cabos de alimentação a montante do quadro eléctrico da unidade, partes metálicas sob tensão	protecção eléctrica adequada da linha de alimentação; máximo cuidado ao efectuar a ligação à terra das partes metálicas
exterior da unidade: zona que circunda a unidade	intoxicações, queimaduras graves	incêndio devido a curto circuito ou sobreaquecimento da linha de alimentação a montante do quadro eléctrico da unidade	secção dos cabos e sistema de protecção da linha de alimentação eléctrica em conformidade com as normas vigentes

2 Introdução

Os motores de compressor, bomba e ventilador possuem uma protecção térmica que os protege de eventuais sobreaquecimentos.

2.1 Transporte

A unidade embalada deve permanecer:

- na posição vertical;
- protegida contra os agentes atmosféricos;
- protegida contra embates..

2.2 Movimentação

Utilizar um empilhador adequado ao peso a elevar, evitando qualquer tipo de embates.

2.3 Inspeção

- Na fábrica, todas as unidades são montadas, cabladas, carregadas com refrigerante e óleo, e testadas;
- após receber a máquina, verificar o respectivo estado: comunicar imediatamente à empresa de transporte eventuais danos;
- desembalar a unidade o mais perto possível do local de instalação.

2.4 Armazenamento

- Manter a unidade embalada num local limpo e protegido da humidade e intempéries.
- não sobreponha as unidades;
- siga as instruções indicadas na embalagem.

3 Instalação

 Para uma instalação ideal, respeitar as indicações dos parágrafos.7.

 O produto instalado deve ser adequadamente protegido contra risco de incêndio (ref. EN378-3).

 **Recomenda-se instalar pré-filtros em todos os refrigeradores junto às respectivas entrada de água (graus de filtração : min.05mm; max1.0mm).**

 **Líquidos a arrefecer**

Os líquidos a arrefecer devem ser compatíveis com os materiais utilizados.

Exemplos de líquidos utilizados são a **água ou misturas de água com etileno ou propileno glicol**.

Os líquidos a arrefecer não devem ser inflamáveis.

Se os líquidos a arrefecer contiverem substâncias perigosas (como, por exemplo, etileno glicol/propileno glicol) deve recolher-se qualquer eventual líquido que saia através de uma zona de fugas, pois ele é nocivo para o meio ambiente. Em caso de esvaziamento do circuito hidráulico, cumpra as normativas vigentes e não elimine o conteúdo no meio ambiente.

3.1 Espaço operativo

 **Deixar um espaço de 1,5 metros em volta da unidade.**

Deixe pelo menos 2 metros de espaço por cima do refrigerador nos modelos com expulsão vertical do ar de condensação.

3.2 Versões

Versão a ar: Ventiladores axiais (A)

Não criar situações de recirculação de ar na zona de refrigeração.

Não obstruir as grelhas de ventilação.

Para as versões com ventiladores axiais é desaconselhada a canalização do ar extraído.

Versão a água (W)



Se a água no condensador estiver em circuito aberto, instale um filtro de rede na entrada da água de condensação.

Para águas de refrigeração especiais (desionizada, desmineralizada, destilada), os materiais padrão previstos para o condensador podem não ser adequados. Nesse caso, queira contactar o fabricante.

3.3 Circuito hidráulico

3.3.1 Controlos e ligação

 **ACertifique-se de que as tubagens estão devidamente limpas antes de ligar o refrigerador e de encher o circuito. Caso contrário, lave-as cuidadosamente.**

  **Se o circuito hidráulico for do tipo fechado, sob pressão é aconselhável a instalação de uma válvula de segurança calibrada : 6 bar.**

 É aconselhável instalar sempre filtros de rede nas tubagens de entrada e saída de água.

 Se o circuito hidráulico for interceptado por válvulas automáticas, proteja a bomba com sistemas anti-golpe de ariete.

 Se o circuito for esvaziado para paragens prolongadas, é aconselhável adicionar líquido de lubrificação no impulsor da bomba para evitar que bloqueie no próximo arranque. No caso de bloqueio do impulsor, proceda ao desbloqueio manual.

Retire a tampa traseira da bomba e rode cuidadosamente a ventoinha de plástico. Se o eixo ainda estiver bloqueado, retire a ventoinha e actue directamente no eixo. Depois de desbloquear o impulsor, volte a colocar a ventoinha e a tampa.

Controlos preliminares

1. Certifique-se de que as eventuais válvulas de intercepção do circuito hidráulico estão abertas.
2. Se o circuito hidráulico for de tipo fechado, certifique-se de que foi instalado um tanque de expansão de capacidade adequada. Consulte o parágrafo 3.3.3.

Ligação

1. Ligue o refrigerador de água às tubagens de entrada e saída, utilizando as respectivas uniões colocadas na parte traseira da unidade. É aconselhável utilizar juntas flexíveis a fim de reduzir a rigidez do sistema.
2. Encha o circuito hidráulico utilizando a união de carregamento própria, posicionada na parte posterior do refrigerador ().
3. O reservatório possui uma válvula de descarga própria que deverá ser accionada manualmente aquando do enchimento. Para isso, se o circuito hidráulico apresentar pontos mais altos, instale uma válvula de purga nesses pontos.
4. É aconselhável dotar as tubagens de entrada e saída de uma torneira, por forma a poder excluir a máquina do circuito em caso de manutenção.
5. Se o refrigerador funcionar com o depósito aberto, a bomba deve ser instalada no lado da aspiração relativamente ao depósito e no lado da descarga relativamente ao refrigerador.

 **Aviso (modelos 022-120): a máquina está equipada com um dispositivo de proteção automática para o tanque.**

Se a entrada de água for fechada inadvertidamente quando a bomba estiver funcionando e a saída de água estiver aberta, o ar entrará no tanque com a provável intervenção do sensor de nível. Será necessário ventilar o circuito hidráulico para eliminar o ar.

Controlos seguintes

1. Ligue o refrigerador de água às tubagens de entrada e saída, utilizando as respectivas uniões colocadas na parte traseira da unidade. É aconselhável utilizar juntas flexíveis a fim de reduzir a rigidez do sistema.
2. Encha o circuito hidráulico utilizando a união de carregamento própria, posicionada na parte posterior do refrigerador.

Características da água

Se não for fornecido, instale um filtro da instalação na entrada de água de condensação.

  Características da água:

Temperatura	≥50°F (10°C)	CL ⁻	<50 ppm
ΔT IN/OUT	5-15°C	CaCO ₃	70-150 ppm
Max % glycol	50	O ₂	<0.1 ppm
Pressão	43.5-145 PSig (3-10 barg)	Fe	<0.2 ppm
PH	7.5-9	NO ₃	<2 ppm
Condutividade eléctrica	10-500 μS/cm	HCO ₃ ⁻	70-300 ppm

Índice de saturação de Langelier	0-1	H ₂ S	<0.05 ppm
SO ₄ ²⁻	<50 ppm	CO ₂	<5 ppm
NH ₃	<1 ppm	Al	<0.2 ppm

Para águas especiais (desionizada, desmineralizada, destilada), os materiais padrão previstos para o refrigerador podem não ser adequados. Nesse caso, queira contactar o fabricante.

3.3.2 Água e etileno glicol

Se o aparelho for instalado ao ar livre ou num ambiente fechado não aquecido, é possível que a água existente no interior do circuito congele nos períodos de paragem do sistema que coincidam com as estações mais frias do ano.

Para reduzir este risco:

- dotar o refrigerador de dispositivos de protecção anti-gelo adequados, fornecidos pelo fabricante como acessórios opcionais;
- descarregar o sistema através da válvula de descarga própria, em caso de paragens prolongadas;
- adicionar uma quantidade adequada de anti-congelante à água de circulação (ver tabela).

Temperatura da água de saída [°C]	Etileno glicol (% vol.)	Temperatura ambiente
4	5	-2
2	10	-5
0	15	-7
-2	20	-10
-4	25	-12
-6	30	-15
-10	40	-20

3.3.3 Tanque de expansão

Para evitar que os aumentos ou as diminuições de volume do fluido, resultantes de uma variação sensível da sua temperatura, danifiquem a máquina ou o circuito, é aconselhável instalar um tanque de expansão de capacidade adequada.

O reservatório de expansão deve ser instalado em aspiração da bomba na união traseira do reservatório.

Para calcular o volume mínimo do tanque de expansão a aplicar a um circuito fechado pode utilizar-se a fórmula seguinte:

$$V = 2 \times V_{tot} \times (P_{t \text{ mín.}} - P_{t \text{ máx.}})$$

sendo que

V_{tot} = vol. total do circuito (em litros)

$P_{t \text{ mín./máx.}}$ = peso específico à temperatura mínima/máxima que a água pode atingir [kg/dm³].

A tabela seguinte apresenta os valores de peso específico em função da temperatura e da percentagem de glicol.

% glycol	Temperatura [°C]						
	-10	0	10	20	30	40	50
0%	1.0024	1.0008	0.9988	0.9964	0.9936	0.9905	0.9869
10%	1.0177	1.0155	1.0130	1.0101	1.0067	1.0030	0.9989
20%	1.0330	1.0303	1.0272	1.0237	1.0199	1.0156	1.0110
30%	1.0483	1.0450	1.0414	1.0374	1.0330	1.0282	1.0230
40%	1.0636	1.0594	1.0525	1.0511	1.0461	1.0408	1.0350

 **Atenção: na fase de enchimento, consultar também os dados de carga do reservatório de expansão.**

Se a temperatura do ar ambiente no resfriador for inferior a -10°C , você deve mover o tanque de expansão para um ambiente protegido perto do lado de retorno de água do resfriador. A válvula de segurança e a válvula de sangria devem permanecer no resfriador.

3.4 Circuito eléctrico

3.4.1 Controlos e ligações



Antes de efectuar qualquer operação nas partes eléctricas, certifique-se da inexistência de tensão.

Todas as conexões eléctricas devem ser efectuadas de acordo com as normas locais relativas ao sítio da instalação.

Controlos iniciais

1. A tensão e a frequência de rede devem corresponder aos valores indicados na chapa de características do refrigerador. A tensão de alimentação não deve, nem mesmo por períodos breves, estar fora da tolerância indicada no esquema eléctrico que, salvo indicações em contrário, corresponde a $\pm 10\%$ no que se refere à tensão; $\pm 1\%$ no que concerne à frequência.
1. A tensão deve ser simétrica (valores eficazes das tensões e ângulos de fase entre fases consecutivas iguais entre si). O desequilíbrio máximo admitido entre as tensões é de 2%.

Ligação

1. A alimentação eléctrica dos refrigeradores é efectuada mediante um cabo de 4 fios, 3 pólos + terra, sem neutro. Para uma secção mínima do cabo, consultar o parágrafo 7.3.
2. Passe o cabo através do buçim situado no painel posterior da máquina e ligue a fase e o neutro aos terminais do seccionador geral (QS). A terra deve ser ligada ao respectivo terminal de terra (PE).
3. Assegure na origem do cabo de alimentação uma protecção contra contactos directos equivalente a pelo menos IP2X ou IPXXB.
4. Instale na linha de alimentação eléctrica do refrigerador um interruptor automático com diferencial de (RCCB - IDn = 0.3A), da capacidade máxima indicada no esquema eléctrico de referência e com um poder de interrupção adequado à corrente de curto circuito existente na zona de instalação da máquina.
A corrente nominal "In" deste disjuntor magnetotérmico deve ser igual a FLA e a curva de intervenção de tipo D.
5. Valor máximo da impedância de rede = 0.274 ohm.

Controlos seguintes

Certifique-se de que a máquina e os aparelhos auxiliares foram ligados à terra e protegidos contra curto-circuitos e/ou sobrecargas.



Uma vez ligada a unidade e uma vez fechado o interruptor geral situado a montante (conferindo, assim, tensão à máquina), a voltagem do circuito eléctrico atinge valores perigosos. Máxima precaução!



É da responsabilidade do instalador realizar os testes mínimos obrigatórios para garantir uma instalação eléctrica adequada, de acordo com os regulamentos locais e em coordenação com o respectivo sistema de ligação à terra, incluindo requisitos específicos para sistemas de neutro isolado (IT).

3.4.2 Alarme general

Todos os refrigeradores estão equipados com os sinais de alarme da máquina (consulte o esquema eléctrico), constituído por um contacto livre existente na placa de terminais: tal permite efectuar as ligações de um alarme central externo, sonoro, visual ou inserido em lógicas ex.: PLC.

3.4.3 ON/OFF por controlo remoto

Todos os refrigeradores prevêem a possibilidade de um arranque e de uma paragem por controlo remoto (parágrafo 7.).

- Para habilitar o rif remoto. nº 16387

- Como variável de referência ON/OFF rif.n.8996

Nota: não habilite juntos "Sup" e "Re" .

Para ligar o contacto ON-OFF remoto, consulte o esquema eléctrico (parágrafo 7.)

3.5 Versão a água (W)

Os refrigeradores na versão com condensação a água necessitam de um circuito hidráulico que transporte a água fria para o condensador.

O refrigerador na versão de água está equipado com uma válvula pressostática, em entrada para o condensador que tem a função de regular o caudal de água de modo a obter sempre uma condensação óptima.

Controlos preliminares

Sea alimentação da água ao condensador for realizada através de circuito fechado, efectue todos os controlos preliminares descritos para o circuito hidráulico principal (par. 3.3.1).

Ligação

1. É aconselhável equipar o circuito da água de condensação com válvulas de intercepção, para poder desactivar a máquina em caso de manutenção.
2. Ligue as tubagens de descarga/retorno de água às respectivas uniões situadas na parte de trás da unidade.
3. Se a água de condensação for "descartável", é aconselhável equipar o circuito com um filtro na entrada do condensador, de modo a limitar o risco de sujidade das superfícies.
4. Se o circuito for de tipo fechado, certifique-se de que se encontra bem cheio de água e correctamente purgado de ar.

4 Controlo

4.1 Painel de controlo



Botão CIMA: prima para aumentar o valor de um parâmetro editável selecionado.



Botão BAIXO: prima para diminuir o valor de um parâmetro editável selecionado.



Botão ESC : para sair sem guardar; voltar ao nível anterior;

PREMIDO POR 5s. RESET DO ALARME.



Botão SET : para sair e guardar/confirmar o valor; passar ao nível seguinte; aceder ao menu Set; **PREMIDO POR 5s. INICIA O REFRIGERADOR.**

4.2 Significado dos símbolos

Símbolo	Estado do símbolo	função	Símbolo	Estado do símbolo	função
	Aceso	Compressor ON		Aceso	Valor da temperatura
	Intermitente	Compressor em standby		Aceso	Valor da pressão
	Apagado	Compressor Off			Aceso
Aceso	Alarme presente	Apagado	Aquecedor anticongelante Off		
Intermitente	Aviso ou Alarme reiniciável		Aceso		Aquecedor do cárter ON Compressor 1
Apagado	Sem alarme		Apagado	Aquecedor do cárter Off Compressor 1	
	Aceso		Bomba 1 ON		Aceso
	Apagado	Bomba 1 Off	Apagado		Aquecedor do cárter Off Compressor 2 (não presente)
	Aceso	Bomba 2 ON (não presente)		Aceso	Aquecedor do cárter ON Compressor 2 (não presente)
	Apagado	Bomba 2 Off (não presente)		Apagado	Aquecedor do cárter Off Compressor 2 (não presente)

4.3 Ligar o refrigerador

1. Ligue a alimentação da máquina rodando o interruptor de alimentação QS para "ON" (ligado).
2. Prima o botão "set" para iniciar.
3. Ajuste a temperatura desejada no controlador. (par. 4.5.1)

Monitor di fase

Se aquando aparecer no visor o alarme "E-23", o utilizador deve certificar-se de que ligou correctamente a cablagem dos terminais de entrada ao interruptor seccionador.

4.3.1 Ajustes aquando da entrada em funcionamento

1. Ajuste da temperatura, consulte o parágrafo 4.5.
2. Regulação da bomba.

Verifique se a bomba funciona correctamente através do manómetro (ler P1 e P0) e verificando os valores limite de pressão (Pmax e Pmin) indicados na placa de dados da bomba.

P1 = pressão com a bomba ON (ligada)

P0 = pressão com a bomba OFF (desligada)

$P_{min} < (P1 - P0) < P_{max}$

- Exemplo n.º1.

Condições:

circuito fechado, pressão P0 = 2 bares

valores da placa de dados da bomba: Pmin 1 bar/Pmax 3 bares

ajuste a saída da válvula para fornecer uma pressão de 3 bares $< P1 < 5$ bares

- Exemplo n.º2.

Condições:

circuito aberto, pressão P0 = 0 bares

valores da placa de dados da bomba: Pmin 1 bar/Pmax 3 bares

ajuste a saída da válvula para fornecer uma pressão de 1 bar $< P1 < 3$ bares

3. Verifique igualmente se a bomba funciona correctamente em condições normais de funcionamento.

Verifique também se a amperagem da bomba se encontra nos limites indicados na placa de dados.

4. Desligue o refrigerador e complete o circuito hidráulico na temperatura "SET".

5. Verifique se a temperatura da água "tratada" não desce abaixo dos 5 °C e que a temperatura ambiente na qual o circuito hidráulico opera não desce abaixo dos 5 °C. Caso a temperatura seja demasiado baixa, adicione a qualidade de glicol apropriada, como explicado no parágrafo 3.3.3.

ATENÇÃO !: antes de ligar a bomba do refrigerador, feche a válvula de saída da água (a instalar pelo cliente).

Mantenha a válvula de entrada (a instalar pelo cliente) sempre aberta.

Ao ligar a bomba, abra lentamente a válvula da água do refrigerador e ajuste o caudal, conforme descrito no ponto 4.3.1.

4.3.2 Começando com água a alta temperatura

No caso de a temperatura da água no circuito ser elevada (por exemplo, 30-35 °C), feche progressivamente (mas não completamente, cerca de dois terços!) a válvula de corte (a cargo do cliente) na saída do chiller para reduzir o fluxo de água através da unidade. Abra gradualmente a válvula assim que a temperatura da água atingir o valor de funcionamento.

Importante: este ajuste permite também evitar golpes de ariete nas tubagens devido a bolsas de ar presentes no circuito (as bolsas de ar devem ser eliminadas através de válvulas de purga de ar nos pontos mais altos do circuito hidráulico a cargo do cliente).

4.4 Parar o refrigerado

Quando já não for necessário o funcionamento do refrigerador, desligue o refrigerador da seguinte forma: Prima o botão "set" (5 Secg).

Não desligue o interruptor de alimentação QS para garantir que todos os dispositivos de protecção anticongelante continuam a receber energia eléctrica.

4.5 Definições de parâmetros

Geral

Existem dois níveis de protecção para os parâmetros:

- Direto User-(U): com acesso imediato, **modificável pelo utilizador**;
- Protegido por password Service-(S): password necessária para aceder, **(não alterar)**.

4.5.1 Parâmetros do refrigerador (CFG)

PARÂMETRO	CÓDIGO	TIPO	PREDEFINIÇÃO
Unidade de medida	R1	U	OFF
Gestão do relé de alarme	CFJ1	U	0
Restaurar os parâmetros predefinidos	DEF	U	OFF
Ativação de On/Off remoto	R7	U	0
Versão do software	UEr	U	1.7.0
Endereço da unidade	CF30	U	1
Taxa de transmissão	CF31	U	5
Protocolo Modbus	CF32	U	1
Ativação de On/Off supervisor	SUP	U	OFF
Ativação do ponto de ajuste dinâmico	ErD	U	OFF

4.5.2 Controlo de temperatura (CNP)

PARÂMETRO	CÓDIGO	TIPO	PREDEFINIÇÃO
Ponto de ajuste de controlo de temperatura (standard)	SEt	U	13.0
Ponto de ajuste de controlo de temperatura (controlo de precisão)	SEt	U	20.0
Diferencial de controlo de temperatura (NÃO presente na configuração "controlo de precisão")	dIF1	U	4.0

4.5.3 Parâmetros de manutenção (Mnt)

PARÂMETRO	CÓDIGO	TIPO	PREDEFINIÇÃO
Horas de funcionamento da unidade	UH	U	-
Horas de funcionamento da unidade (X1000)	UHL	U	-
Horas de funcionamento parcial da unidade	UPH	U	-

PARÂMETRO	CÓDIGO	TIPO	PREDEFINIÇÃO
Horas de funcionamento parcial da unidade (X1000)	UPHL	U	-
Horas de funcionamento do compressor 1	CH	U	-
Horas de funcionamento do compressor 1 (x1000)	CHL	U	-

4.5.4 Parâmetros da sonda (bt1, bt2)

Sonda (bt1)

PARÂMETRO	CÓDIGO	TIPO	PREDEFINIÇÃO
Alarme de alta temperatura (água)	HR1	U	60

Sonda (bt2)

PARÂMETRO	CÓDIGO	TIPO	PREDEFINIÇÃO
Alarme de alta temperatura (água)	HR2	U	60







4.5.5 Histórico de alarmes (ALH1)

PARÂMETRO	CÓDIGO	TIPO	PREDEFINIÇÃO
Número do alarme	HYS1	U	-
Ver código do alarme	HYS2	U	-
Ver dia e mês do alarme	HYS3	U	-
Ver hora e minutos do alarme	HYS4	U	-
Temperatura bt1 no momento do alarme	HYS1	U	-
Temperatura bt2 no momento do alarme	HYS2	U	-
Condições SET no momento do alarme	HYS3	U	-









4.6 Alterar parâmetros (User)

4.6.1 Parâmetros do refrigerador "CF9"

Unidade de medida

Ligue o refrigerador "ON" usando o interruptor do seccionador principal QS e aguarde a indicação "OFF" no display. Prima os botões "esc" "set" em simultâneo para aceder aos parâmetros "U".	
Aparece o parâmetro "PAr". Prima o botão "set" para entrar.	
Aparece o parâmetro "CF9". Prima o botão "set" para entrar.	
Aparece o parâmetro "A1". Prima o botão "set" para entrar	
O valor predefinido é "OFF" = °C Use os botões "⇩" e "⇧" para selecionar a unidade de medida. OFF : temperatura = C°, Celsius ; pressão = Bar; On : temperatura = °F, Fahrenheit; Pressão =PSI	
Prima o botão "set" para confirmar.	
Regressa automaticamente a "A1" O parâmetro já foi armazenado. Prima o botão "esc" para sair, três vezes.	

Gestão dos alarmes

Ligue o refrigerador "ON" usando o interruptor do seccionador principal QS e aguarde a indicação "OFF" no display. Prima os botões "esc" "set" em simultâneo para aceder aos parâmetros "U".	
Aparece o parâmetro "PAr". Prima o botão "set" para entrar.	
Aparece o parâmetro "CF9". Prima o botão "set" para entrar.	
Aparece o parâmetro "A1". Use os botões "⇩" e "⇧" para selecionar o parâmetro "CFJ1".	
Prima o botão "set" para entrar.	
O valor predefinido é "0" Use os botões "⇩" e "⇧" para selecionar a gestão do relé de alarme (par. 4.5.1- Tab.1)	
Prima o botão "set" para confirmar.	
Regressa automaticamente a "CFJ1" O parâmetro já foi armazenado. Prima o botão "esc" para sair, três vezes.	

Tab.1 Gestão do relé de alarme (CFJ1.)

0	Relé normalmente desativado, acionado por alarme.
1	Relé normalmente acionado (também com controlo OFF), desativado por um alarme.
2	Relé normalmente acionado (apenas com controlo ON), desativado por um alarme ou por controlo OFF.

Parâmetros predefinidos

Ligue o refrigerador "ON" usando o interruptor do seccionador principal QS e aguarde a indicação "OFF" no display. Prima os botões "esc" e "set" em simultâneo para aceder aos parâmetros "U".	
Aparece o parâmetro "PAR". Prima o botão "set" para entrar.	
Aparece o parâmetro "CF9". Prima o botão "set" para entrar.	
Aparece o parâmetro "A1". Use os botões "set" e "esc" para selecionar o parâmetro "dEF".	
Prima o botão "set" para entrar.	
O valor predefinido é "OFF". Use os botões "set" e "esc" para mudar de "OFF" para "On".	
Prima o botão "set" para confirmar.	
Após alguns segundos, volta para "OFF". Os parâmetros foram redefinidos automaticamente. Prima o botão "esc" para sair, três vezes.	







ON/OFF Remoto

Ligue o refrigerador "ON" usando o interruptor do seccionador principal QS e aguarde a indicação "OFF" no display. Prima os botões "esc" e "set" em simultâneo para aceder aos parâmetros "U".	
Aparece o parâmetro "PAR". Prima o botão "set" para entrar.	
Aparece o parâmetro "CF9". Prima o botão "set" para entrar.	
Aparece o parâmetro "A1". Use os botões "set" e "esc" para selecionar o parâmetro "A7".	
Prima o botão "set" para entrar.	
O valor predefinido é "0". Use os botões "set" e "esc" para selecionar o modo: (par. 4.5.1- Tab.2)	
Prima o botão "set" para confirmar.	
Regressa automaticamente a "A7". O parâmetro já foi armazenado. Prima o botão "esc" para sair, três vezes.	





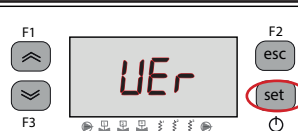

Tab.2 Modo On/Off remoto (A7)

0	On/Off remoto desativado
1	On/Off remoto ativado juntamente com On/Off local. Em caso de falha de energia ou caso o interruptor principal seja desligado, aquando do regresso da energia o refrigerador deverá ser reiniciado localmente
2	Apenas On/Off remoto, On/Off local desativado



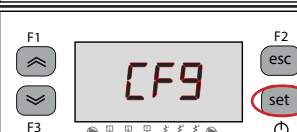

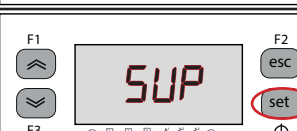

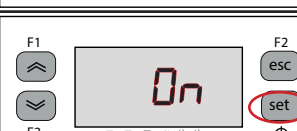
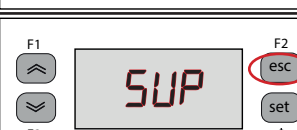
Versão do software (apenas de leitura)

<p>Ligue o refrigerador "ON" usando o interruptor do seccionador principal QS e aguarde a indicação "OFF" no display.</p> <p>Prima os botões "esc" e "set" em simultâneo para aceder aos parâmetros "U".</p>	
<p>Aparece o parâmetro "PAr".</p> <p>Prima o botão "set" para entrar.</p>	
<p>Aparece o parâmetro "CF9".</p> <p>Prima o botão "set" para entrar.</p>	
<p>Aparece o parâmetro "A i".</p> <p>Use os botões "set" e "set" para selecionar o parâmetro "UEr".</p>	
<p>Prima o botão "set" para entrar.</p>	
<p>A versão do software é mostrada</p>	
<p>Prima o botão "esc" para sair, três vezes.</p>	



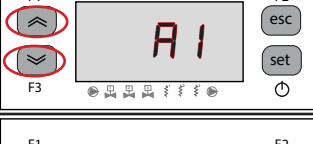

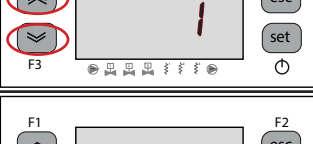
Ativação do supervisor

<p>Ligue o refrigerador "ON" usando o interruptor do seccionador principal QS e aguarde a indicação "OFF" no display.</p> <p>Prima os botões "esc" e "set" em simultâneo para aceder aos parâmetros "U".</p>	
<p>Aparece o parâmetro "PAr".</p> <p>Prima o botão "set" para entrar.</p>	
<p>Aparece o parâmetro "CF9".</p> <p>Prima o botão "set" para entrar.</p>	
<p>Aparece o parâmetro "A i".</p> <p>Use os botões "set" e "set" para selecionar o parâmetro "SUP".</p>	
<p>Prima o botão "set" para entrar.</p>	
<p>O valor predefinido é "OFF"</p> <p>Use os botões "set" e "set" para alterar.</p>	
<p>Prima o botão "set" para confirmar.</p>	
<p>O parâmetro já foi armazenado.</p> <p>Prima o botão "esc" para sair, três vezes.</p>	

Modbus (endereço)

Ligue o refrigerador "ON" usando o interruptor do seccionador principal QS e aguarde a indicação "OFF" no display. Prima os botões "esc" e "set" em simultâneo para aceder aos parâmetros "U".	
Aparece o parâmetro "PAr". Prima o botão "set" para entrar.	
Aparece o parâmetro "CF9". Prima o botão "set" para entrar.	
Aparece o parâmetro "A i". Use os botões "↵" e "⏪" para seleccionar o parâmetro "CF30".	
Prima o botão "set" para entrar.	
O valor predefinido é "1". Use os botões "↵" e "⏪" para alterar o endereço.	
Prima o botão "set" para confirmar.	
O parâmetro já foi armazenado. Prima o botão "esc" para sair, três vezes.	

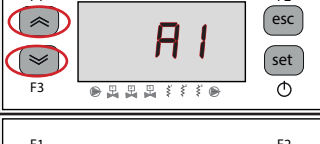
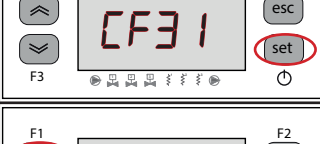
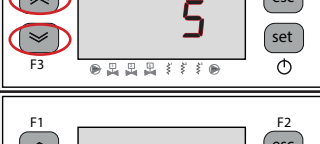





Modbus (taxa de transmissão)

Ligue o refrigerador "ON" usando o interruptor do seccionador principal QS e aguarde a indicação "OFF" no display. Prima os botões "esc" e "set" em simultâneo para aceder aos parâmetros "U".	
Aparece o parâmetro "PAr". Prima o botão "set" para entrar.	
Aparece o parâmetro "CF9". Prima o botão "set" para entrar.	
Aparece o parâmetro "A i". Use os botões "↵" e "⏪" para seleccionar o parâmetro "CF31".	
Prima o botão "set" para entrar.	
O valor predefinido é "5". Use os botões "↵" e "⏪" para alterar o protocolo. (par. 4.5.1- Tab.3)	
Prima o botão "set" para confirmar.	
O parâmetro já foi armazenado. Prima o botão "esc" para sair, três vezes.	

Tab.3 Taxa de transmissão (opcional) (CF31)

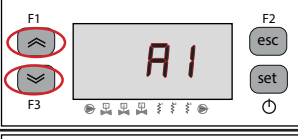
1	2400	3	9600	5	38400	7	115200
2	4800	4	19200	6	57600		

Modbus (protocolo)









Ligue o refrigerador "ON" usando o interruptor do seccionador principal QS e aguarde a indicação "OFF" no display. Prima os botões "esc" e "set" em simultâneo para aceder aos parâmetros "U".	
Aparece o parâmetro "PAR". Prima o botão "set" para entrar.	
Aparece o parâmetro "CFG". Prima o botão "set" para entrar.	
Aparece o parâmetro "A1". Use os botões "down" e "up" para seleccionar o parâmetro "CF32".	
Prima o botão "set" para entrar.	
O valor predefinido é "3". Use os botões "down" e "up" para alterar a taxa de transmissão. (par. 4.5.1- Tab.4)	
Prima o botão "set" para confirmar.	
O parâmetro já foi armazenado. Prima o botão "esc" para sair, três vezes.	

Tab.4 Protocolo modbus (opcional) (CF32)

1	PAR	2	NENHUM	3	ÍMPAR
---	-----	---	--------	---	-------

 Nota: se alterar os parâmetros MODBUS, para validar os novos parâmetros deve desligar o refrigerador e, em seguida, voltar a ligá-lo novamente.

Ativação do ERD

Ligue o refrigerador "ON" usando o interruptor do seccionador principal QS e aguarde a indicação "OFF" no display. Prima os botões "esc" e "set" em simultâneo para aceder aos parâmetros "U".	
Aparece o parâmetro "PAR". Prima o botão "set" para entrar.	
Aparece o parâmetro "CFG". Prima o botão "set" para entrar.	
Aparece o parâmetro "A1". Use os botões "down" e "up" para seleccionar o parâmetro "Erd".	
Prima o botão "set" para entrar.	
O valor predefinido é "OFF". Use os botões "down" e "up" para alterar.	
Prima o botão "set" para confirmar.	
O parâmetro já foi armazenado. Prima o botão "esc" para sair, três vezes.	

 Com o parâmetro ERD ativo: A temperatura definida da água muda com base na temperatura ambiente. A função só fica ativa se o controlo de precisão de temperatura estiver desativado (CPT=OFF).

4.6.2 Controlo de temperatura "CNP"

Configuração do controlo de temperatura

Ligue o refrigerador "ON" usando o interruptor do seccionador principal QS e aguarde a indicação "OFF" no display. Prima os botões "esc" "set" em simultâneo para aceder aos parâmetros "U".	
Aparece o parâmetro "PAR". Prima o botão "set" para entrar.	
Aparece o parâmetro "CFG". Use os botões "≡" e "⏪" para seleccionar o parâmetro "CNP".	
Prima o botão "set" para entrar.	
Aparece o parâmetro "SEt". Prima o botão "set" para entrar.	
O valor predefinido é "13.0". Use os botões "≡" e "⏪" para alterar o valor.	
Prima o botão "set" para confirmar.	
O parâmetro já foi armazenado. Prima o botão "esc" para sair, três vezes.	

Importante: Uma definição de temperatura entre 1°C e 5°C deve ser feita por técnicos especializados que devem utilizar o manual de serviço específico deste produto.

Regulação do diferencial de temperatura

Ligue o refrigerador "ON" usando o interruptor do seccionador principal QS e aguarde a indicação "OFF" no display. Prima os botões "esc" "set" em simultâneo para aceder aos parâmetros "U".	
Aparece o parâmetro "PAR". Prima o botão "set" para entrar.	
Aparece o parâmetro "CFG". Use os botões "≡" e "⏪" para seleccionar o parâmetro "CNP".	
Prima o botão "set" para entrar.	
Aparece o parâmetro "SEt". Use os botões "≡" e "⏪" para seleccionar o parâmetro "diF1".	
Prima o botão "set" para entrar.	
O valor predefinido é "4.0". Use os botões "≡" e "⏪" para alterar o valor.	
Prima o botão "set" para confirmar.	
O parâmetro já foi armazenado. Prima o botão "esc" para sair, três vezes.	

4.6.3 Parâmetro da sonda "bt 1"

Sonda "bt 1".

Ligue o refrigerador "ON" usando o interruptor do seccionador principal QS e aguarde a indicação "OFF" no display. Prima os botões "esc" e "set" em simultâneo para aceder aos parâmetros "U".	
Aparece o parâmetro "PAR". Prima o botão "set" para entrar.	
Aparece o parâmetro "CF9". Use os botões "↵" e "⏪" para seleccionar o parâmetro "bt1".	
Prima o botão "set" para entrar.	
Aparece o parâmetro "HA 1". Prima o botão "set" para entrar.	
O valor predefinido é "60.0". Use os botões "↵" e "⏪" para alterar o valor.	
Prima o botão "set" para confirmar.	
O parâmetro já foi armazenado. Prima o botão "esc" para sair, três vezes.	

Mesma sequência para a sonda "bt2".

4.7 Visualização sonda/ ventilador/ compressor

Refrigerador em funcionamento. Prima o botão "⏪" para ver as sondas bt 1, bt 2, bt 3, bP 1.....	
Selecione a sonda e aguarde alguns segundos. (Ex. BT2)	
Aparece o valor da sonda bt2.	
É aconselhável voltar sempre à sonda bt 1	

Descrição:

- bt 1 : sonda da temperatura da água de saída
- bt 2 : sonda da temperatura do evaporador
- bt 3 : sonda da temperatura ambiente
- bt 10 : sonda da temperatura do painel elétrico (opção)
- bP 1 : transmissor circuito 1
- bP2 : transmissor circuito 1; (do modelo ICEP080)









F... : funcionamento do ventilador:



- F... : ventilador desligado
- F- : ventilador 1 ligado, ventilador 2,3 desligado: (2 = do modelo ICEP022) (3 = do modelo ICEP080)
- F-- : ventiladores 1 e 2 ON, ventilador 3 OFF, (2 = do modelo ICEP022) (3 = do modelo ICEP080)
- F--- : ventiladores 1,2 e 3 ON (do modelo ICEP080)

ICE funcionamento dos compressores:

- ICE : compressores desativados
- ICE- : compressores desligados
- ICE- : compressor 1 ligado, compressor 2 desligados
- ICE2 : compressores 1 e 2 ligado; (do modelo ICEP055)
- ICE- : com "1" compressor Intermitente pronto para arrancar, compressor 2 desligados









4.8 Ajuste da hora/data

<p>Ligue o refrigerador "ON" usando o interruptor do seccionador principal QS e aguarde a indicação "OFF" no display.</p> <p>Prima os botões "⏪" e "⏩" em simultâneo para aceder ao menu "Data/hora".</p>	
<p>Aparece o parâmetro "FrEE".</p> <p>Prima o botão "set" para entrar.</p>	
<p>Aparece o parâmetro "A1".</p> <p>Use os botões "⏪" e "⏩" para seleccionar o parâmetro "CL".</p>	
<p>Prima o botão "set" para entrar.</p>	
<p>Aparece o parâmetro "HOuR".</p> <p>Prima durante 5 segundos o botão "set".</p> <p>O parâmetro está agora intermitente.</p>	
<p>Use os botões "⏪" e "⏩" para seleccionar a data, hora ou ano para alterar.</p>	
<p>Prima o botão "set" para entrar.</p>	
<p>Use os botões "⏪" e "⏩" para alterar o valor (ex.: ano)</p>	
<p>Prima o botão "set" para confirmar.</p>	

<p>Use os botões "⏪" e "⏩" para alterar outro valor (ex.: data)</p>	
<p>Prima o botão "esc" para sair.</p> <p>O parâmetro deixa de piscar.</p>	
<p>Prima os botões "⏪" e "⏩" em simultâneo para sair.</p>	

⚠ A memória da "hora/data" tem uma duração máxima de três dias pelo que, se o controlador ficar sem energia durante um período de tempo superior a três dias, o ajuste da hora/data será perdido. Ajuste o relógio durante a fase de arranque da máquina e sempre que necessário.

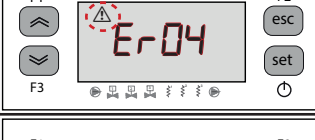



4.9 Gestão dos alarmes

<p>Na presença de um alarme, aparece o código de alarme e um símbolo no canto superior esquerdo</p> <p> Contínuo = alarme presente Intermitente = aviso presente/alarme reiniciável</p>	
<p>Prima o botão "set" para entrar.</p>	
<p>Aparece o parâmetro "ALH 1".</p> <p>Prima o botão "↵" para seleccionar o parâmetro "AL"</p>	
<p>Prima o botão "set" para entrar.</p>	
<p>Aparece o código de alarme ex.: "Er04".</p> <p>Prima o botão "↵" para verificar se há mais alarmes presentes.</p>	
<p>Repare a falha antes de executar o reset. Uma vez reparada a falha, o símbolo de alarme começa a piscar. Agora pode executar o reset.</p>	
<p>prima o botão "esc" até o alarme desaparecer.</p>	

Lista de alarmes/avisos

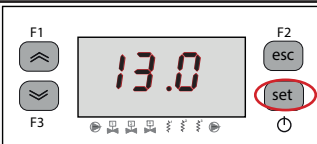
Código	Descrição	Ação	Reset
Er01	Sensor bt1 cortado ou avariado	Alarme	M
Er02	Sensor bt2 cortado ou avariado	Alarme	M
Er03	Sensor bt3 cortado ou avariado	Alarme	A
Er05	Sensor bt10 cortado ou avariado	Alarme	A
Er06	Sensor bP1 cortado ou avariado	Alarme	M
Er08	Circuito do interruptor de alta pressão 1	Alarme	M
Er09	Circuito do interruptor de baixa pressão 1	Alarme	M
Er12	Alta temperatura bt1	Alarme	M
Er13	Baixa temperatura bt1	Alarme	A
Er14	Alta temperatura bt2	Alarme	M
Er15	Baixa temperatura bt2	Alarme	M
Er16	Alta temperatura bt3	Alarme	A
Er17	Baixa temperatura bt3	Alarme	A
Er18	Proteção térmica do compressor 1	Alarme	M
Er20	Proteção térmica da bomba 1	Alarme	M
Er22	Baixo nível de água / Interruptor de pressão diferencial	Alarme	M
Er23	Monitor de fase	Alarme	M
Er24	Expansão avariada ou desconectada	Alarme	M
Er25	Horas de funcionamento do compressor 1 excedidas	Aviso	M
Er27	Horas de funcionamento da unidade excedidas	Aviso	M
Er28	Memória do relógio	Aviso	A
Er29	Configuração do refrigerador	Aviso	A





4.10 Histórico de alarmes

Refrigerador em funcionamento. Prima o botão "set" para ver o histórico de alarmes.	
Prima o botão "set" para entrar.	
Use os botões "↵" e "⏪" para ver os parâmetros. (Par. 4.5.5)	
Prima o botão "set" para ver o valor.	

5 Manutenção

- A máquina foi concebida e fabricada para garantir uma grande longevidade; no entanto, a duração dos respectivos componentes está directamente ligada à manutenção efectuada.
-  Em caso de um pedido de assistência ou de peças de substituição, identificar a máquina (modelo e número de série) lendo a placa de características no exterior da unidade. (www.polewr.com)

5.1 Advertências gerais

-  Antes de efectuar qualquer manutenção, verifique se o refrigerador está desligado.
-  Utilizar sempre peças de substituição originais do fabricante: caso contrário, o fabricante não se responsabiliza por qualquer avaria da máquina.
-  Em caso de perda de refrigerante, contactar pessoal qualificado e autorizado.
-  A válvula Schrader deve ser utilizada apenas em caso de um funcionamento incorrecto da máquina: caso contrário, os danos provocados por um carregamento errado do refrigerante não serão reconhecidos na garantia..

5.2 Refrigerante













Operação de carga: eventuais danos provocados por uma carga errada levada a cabo por pessoal não autorizado não serão reconhecidos na garantia. 

-  O aparelho contém gases fluorados com efeito de estufa.
O líquido refrigerante R513A à temperatura e pressão normal é um gás incolor pertencente ao SAFETY GROUP A1 - EN378 (líquido de grupo 2 segundo a directiva PED 2014/68/UE); GWP (Global Warming Potential) = 629.

-  Em caso de fuga de refrigerante, arejar o local.

5.3 Programa de manutenção preventiva

Para garantir a máxima eficiência e fiabilidade do refrigerador ao longo do tempo, proceder do seguinte modo:

Descrição das actividadesde manutenção	Maintenance Interval (standard operating conditions)			
	Todos os dias	A cada 6 meses	Anualmente	A cada 36 meses
Actividade verificar  assistência 				
Verifique se a luz avisadora POWER ON está acesa.				
Verifique os indicadores do painel de controlo				
Limpe as aletas do condensador.				
Verifique o consumo eléctrico.				
Check refrigerant leaks				
Verifique e limpe as Válvula de segurança água (se presente)*				
Verificar o sistema eléctrico e o quadro eléctrico**				
Verifique as sondas das temperaturas. Substitua-as se necessário.				 
Kit de manutenção				

 Estão disponíveis (consultar o parágrafo 7.):

- a) kit de serviço: kit eléctrico; kit do compressor; kit do ventilador; kit do evaporador; kit do bomba; kit do Reservatório de água;
- b) peças de substituição avulso.

*Para garantir a eficiência total, as válvulas de segurança devem ser verificadas periodicamente. Com o tempo, as impurezas podem acumular-se perto do tampão; por conseguinte, é necessária a lavagem periódica do local. Esta descarga é obtida drenando manualmente a válvula, rodando o botão na direcção indicada pelas setas.

Importante: Certifique-se, após esta operação, de que a pressão de funcionamento é restabelecida.

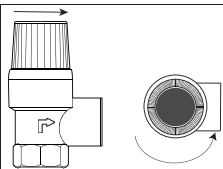



** Durante a manutenção periódica, o sistema eléctrico da máquina e o quadro eléctrico devem também

ser verificados de acordo com a legislação local. Além disso, sempre que possível, deve ser efetuada uma inspeção visual do equipamento e dos condutores eléctricos, e deve também ser verificado o aperto correto dos terminais dos componentes de alimentação, de acordo com os binários de aperto especificados no esquema eléctrico.

5.4 Desmontagem

O líquido refrigerante e o óleo lubrificante que existe no circuito devem ser recuperados em conformidade com as normas ambientais locais em vigor.

A recuperação do líquido refrigerante deve ter lugar antes da eliminação final do equipamento ((UE) N° 517/2014 art. 8.).

	RECICLAGEM DESMANTELAMENTO 
Estrutura	aço/resinas epóxicas, poliéster
Reservatório	alumínio/cobre/aço
Tubagem/colectores	cobre/alumínio/aço ao carbono
Isolamento da tubagem	borracha de nitrilo (NBR)
Compressor	aço/cobre/alumínio/óleo
Condensador	aço/cobre/alumínio
Bomba	aço/ferro fundido/latão
Ventilador	alumínio
Refrigerante	R513A
Válvulas	latão/cobre
Cabos eléctricos	cobre/PVC

Os equipamentos que contenham componentes eléctricos devem ser descartados separadamente junto com os resíduos eléctricos e eletrónicos de acordo com a legislação local e vigente.



6 Localização de avarias

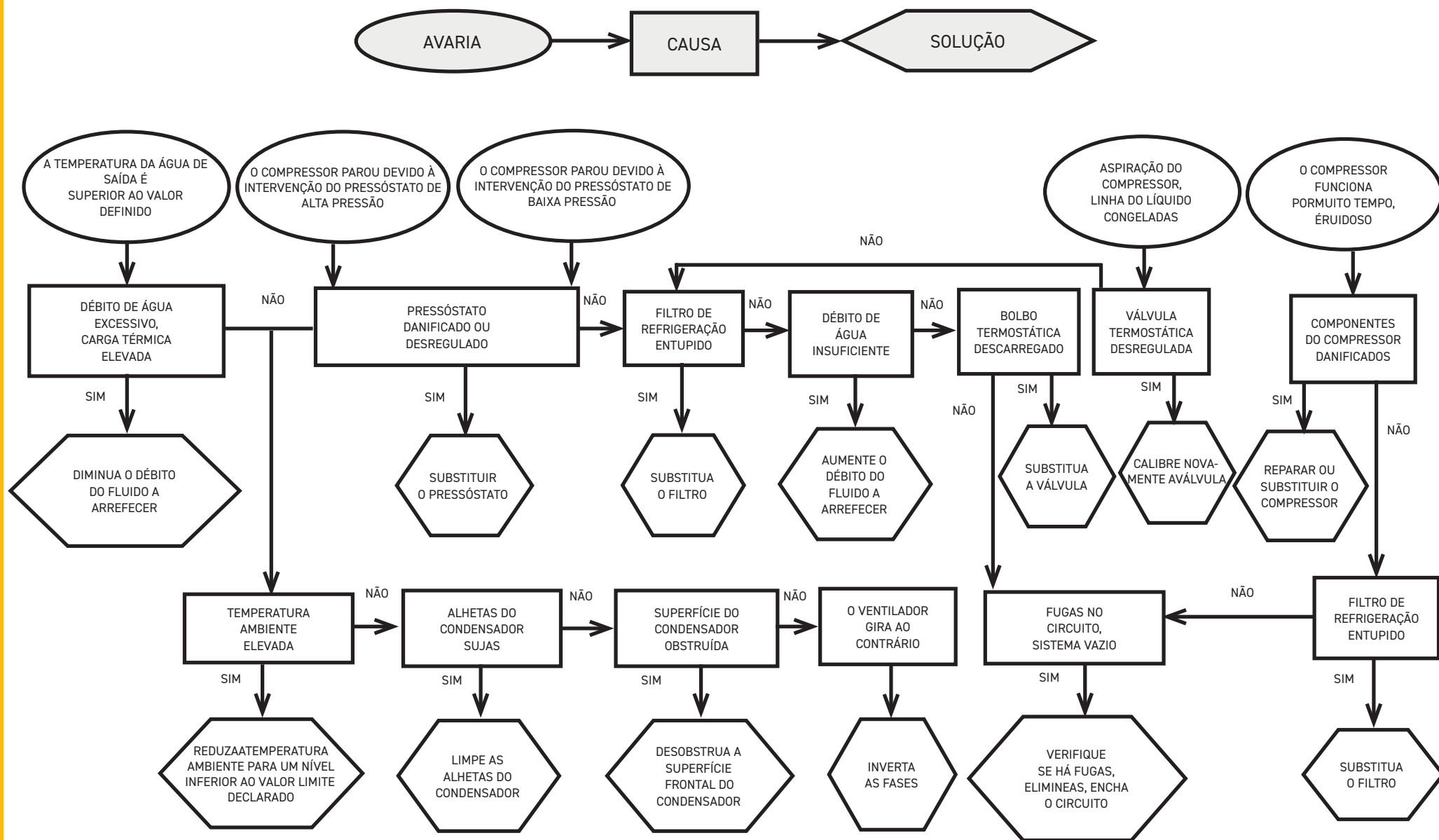

1 Säkerhet	2
1.1 Manualens betydelse	2
1.2 Varningsskyltar.....	2
1.3 Säkerhetsanvisningar.....	2
1.4 Kvarstående risker	2
2 Inledning	3
2.1 Transport	3
2.2 Hantering.....	3
2.3 Inspektion.....	3
2.4 Magasinering.....	3
3 Installation	3
3.1 Utrymme som krävs för arbetet.....	3
3.2 Versioner.....	3
3.3 Hydraulisk krets	3
3.3.1 Kontroller och anslutning	3
3.3.2 Vatten och etylglykol.....	4
3.3.3 Expansionskärl	4
3.4 El-krets	5
3.4.1 Kontroller och anslutningar	5
3.4.2 Allmänna larm	5
3.4.3 Fjärrkontroll ON/OFF	5
3.5 Vattenversion (W).....	5
4 Kontroll	6
4.1 Kontrollpanel.....	6
4.2 Symbolernas betydelse.....	6
4.3 Att starta kylaren.....	6
4.3.1 Adjustments at commissioning	6
4.3.2 Börja med högtemperaturvatten	6
4.4 Att stänga av kylaren.....	7
4.5 Parameterinställningar	7
4.5.1 Kylarparametrar (CF9).....	7
4.5.2 Temperaturstyrning (CIP).....	7
4.5.3 Underhållsparametrar (PnE).....	7
4.5.4 Prob parametrar (bE 1, bE2).....	7
4.5.5 Larmhistorik (RLH i).....	7
4.6 Ändra parametrar (User).....	8
4.6.1 Kylarparametrar "CF9".....	8
4.6.2 Temperaturstyrning "CIP"	13
4.6.3 Prob parameter "bE 1"	14
4.7 Visning av sensor/ fläkt/ kompressor	14
4.8 Ställa in klocka/ datum	15
4.9 Larmhantering	16
4.10 Larmhistorik	17
5 Underhåll	17
5.1 Allmän information	17
5.2 Kylmede.....	17
5.3 Program för förebyggande underhåll.....	18
5.4 Isärtagning	18

7 Bilaga





7.1 Teckenförklaring
7.2 Installationsschema
7.3 Hantering - Utrymme som krävs för arbetet
7.4 Tekniska data
7.5 Mått
7.6 Reservdelstlista
7.7 Sprängskisser
7.8 Kretsschema
7.9 Kopplingschema

1 Säkerhet

1.1 Manualens betydelse

- Spar manualen under maskinens hela livstid.
- Läs alltid manualen innan någon typ av ingrepp görs.
- Ändringar kan göras i manualen. Uppdaterad information finns i manualversionen som medföljer maskinen.

1.2 Varningsskyltar

	Instruktioner för att undvika risker för människor.
	Instruktioner för att undvika risker för utrustningen.
	Det krävs att en teknisk fackman är närvarande.
	Symboler vars betydelse förklaras i avsnittet 7.

1.3 Säkerhetsanvisningar

 Varje maskin är utrustad med en elektrisk frånskiljare som gör att arbetet kan ske i full säkerhet. Använd alltid denna frånskiljare för att undanröja faror innan underhåll utförs.

 Manualen riktar sig till slutanvändaren endast vad gäller de arbetsmoment som kan göras med stängda paneler. Arbeten installation/ underhåll/idrifttagning som kräver att paneler öppnas med verktyg måste göras av fackutbildad personal.

 Endast för installation på platser som inte är tillgängliga för allmänheten, antingen på en säker plats med begränsad åtkomst eller på en höjd av minst 2,5 m eller i säkra takutrymmen, såvida de inte har övervakats eller fått instruktioner om användningen av apparaten av en person som ansvarar för deras säkerhet.



 Installationsavståndet från väggen och det fria driftsutrymmet anges i avsnitt 7.3.

 Observera: respektera min./max. temperatur och tryck som anges i avsnitt 7.4, och det totala driftstemperaturintervallet som anges i avsnitt 7.2.

 Alla enheter kan installeras utomhus.

 Alla elektriska anslutningar måste överensstämma med de lokala föreskrifterna på installationsplatsen.

 Överskrid inte projektsgränserna som finns på dataskylten.

  Det åligger användaren att undvika andra belastningar än det inre statiska trycket. Om det finns risk för systemisk aktivitet måste enheten skyddas på lämpligt sätt. Använd maskinen uteslutande för yrkesbruk och för det bruk som den är avsedd för.

 Det åligger användaren att analysera alla aspekter av applikationen där produkten skall installeras, att följa alla tillämpliga industristandarder om säkerhet och alla föreskrifter gällande produkten som finns i bruksanvisningen och i alla handlingar som medföljer enheten.

Ändringar eller byten av komponenter som utförs av personal som inte är auktoriserad för ändamålet och/eller olämplig användning av maskinen gör garantin ogiltig.

Tillverkaren accepterar inget ansvar för personskador, skador på föremål eller på själva maskinen som orsakas av personalens försummelser, av bristande respekt för instruktionerna i denna manual, av bristande tillämpning av gällande bestämmelser om anläggningens säkerhet.

Tillverkaren accepterar inget ansvar för skador som orsakas av ändringar och/eller modifieringar av emballaget.

Det åligger användaren att se till att tillhandahållna specifikationer om val av enhet eller dess komponenter och/eller tillvalsfunktioner är tillräckligt uttömmande för att användningen av enheten och dess komponenter skall kunna ske på korrekt eller rimligen förutsägbart sätt.

 **OBS: Tillverkaren förbehåller sig rätten att ändra informationerna i denna handbok utan att på förhand underrätta om detta.**

För en komplett och uppdaterad information rekommenderas användaren att konsultera handboken på enheten.

1.4 Kvarstående risker

Installationen, starten, avstängningen, underhållet av maskinen måste utföras i överensstämmelse med vad angivet i den tekniska dokumentationen för maskinen och alltid på sådant sätt att den inte ger upphov till någon risksituation.

Riskerna som inte varit möjliga att eliminera under projekteringsfasen anges i följande tabell.

påverkad del	kvarstående risk	exponerings sätt	försiktighetsåtgärd
värmeväxlingsspole	små skärsår	kontakt	undvik kontakt, använd skyddshandskar
fläktgaller och fläkt	lesioner	införande av spetsiga föremål genom gallret medan fläkten fungerar	för inte in några föremål i fläktgallren och lägg inga föremål ovanpå gallren
invändigt enheten: kompressor och tryckrör	brännskador	kontakt	undvik kontakt, använd skyddshandskar

påverkad del	kvarstående risk	exponeringssätt	försiktighetsåtgärd
invändigt enheten: metalldelar och elektriska kablar	förgiftningar, elektriska stötar, allvarliga brännskador	isoleringsfel på matar-kablar före enhetens elpanel, metalldelar under spänning	passande elektriskt skydd på matarlinjen; yttersta omsorg när du jordar metalldelarna
utvändigt enheten: område omkring maskinen	förgiftningar, allvarliga brännskador	eldsvåda orsakad av kortslutning eller överhettning av matarlinjen före enhetens elpanel	försäkra dig om att genomskärningsytan av kablarna och skyddssystemet för den elektriska matarlinjen är i överensstämmelse med gällande normer

2 Inledning

Motorerna till kompressorn, pumpen och fläkten är utrustade med termoskydd som skyddar dem mot överhettning. .

2.1 Transport

Den emballerade enheten måste:

- vara i vertikalt läge,
- skyddas mot vädrets verkan,
- skyddas mot stötar.

2.2 Hantering

Använd en gaffeltruck som är lämpad för vikten som skall lyftas. Undvik stötar.

2.3 Inspektion

- På fabriken assembleras samtliga delar, förses med kablar, fylls med kylmedel och olja och besiktigas.
- Kontrollera maskinens skick vid mottagandet och reklamera omgående eventuella skador till transportfirman.
- Avlägsna emballaget från enheten så nära installationsplatsen som möjligt.

2.4 Magasinering

- Förvara den emballerade enheten på en ren plats där den skyddas mot fukt och vädrets inverkan.
- stapla inte enheterna;
- följ instruktionerna på emballaget.

3 Installation

 Följ anvisningarna i avsnitten 7. så att installation blir optimal.

 Den installerade produkten måste skyddas mot brandrisk (ref. EN378-3).

 **Vi rekommenderar att alla kylare utrustas med korrekt förfiltrering vid kylarens inloppsanslutning (filtreringsgrader: min.05mm; max1.0mm).**

 **Vätskor att kyla**

Vätskorna som ska kylas måste vara kompatibla med de använda materialerna.

Exempel på använda vätskor: **vatten eller blandningar av vatten och etylen- eller propylenglykol.**

Vätskorna som ska kylas får inte vara lättantändliga.

Om vätskorna som skall kylas innehåller farliga ämnen (t.ex. etylen-/propylenglykol) måste vätskor från läckor samlas upp, eftersom sådana vätskor är skadliga för miljön. Följ gällande bestämmelser när vattenkretsen måste tömmas. Se till innehållet inte sprids i omgivningen.

3.1 Utrymme som krävs för arbetet

 Lämna ett utrymme på minst 1,5 meter runt enheten.

Lämna minst 2 meters tomrum ovanför kylarmodeller med vertikalt utsläpp av kondensationsluften.

3.2 Versioner

Luftversion: Axialfläktar (A)

Se till att det inte skapas situationer där kyl luften återcirkuleras.

Täpp inte igen ventilationsgallren.

För versioner med axialfläktar rekommenderas inte kanalisering av den förbrukade luften.

Vattenversion (W)

Om vattenkretsen till kondensatorn är öppen skall ett nätfiler installeras på kondensvattenintaget.

För särskilda kylvatten (avjoniserat, demineraliserat, destillerat) kan standardmaterialen förutsedda för kondensatorn vara olämpliga. I sådana fall ombedes du kontakta tillverkaren.

3.3 Hydraulisk krets

3.3.1 Kontroller och anslutning

 Innan du ansluter kylaren och fyller kretsen, förvissa dig om att rörsystemen är rena. Om så inte skulle vara fallet utför en noggrann rengöring..

  **Om vattenkretsen är stängd är en säkerhetsventil installerad på trycksidan: 6 bar.**

 Vi rekommenderar att silfilter alltid installeras i vattenrörens inlopp och utlopp.

 Om den hydrauliska kretsen stängs av med automatiska ventiler måste pumpen skyddas med hjälp av system mot plötsliga stopp i vattenflödet i rörledningarna.

 Om kretsen töms för längre driftsuppehåll är det lämpligt att tillsätta smörjvätska på pumphjulet för att undvika stopp vid påföljande start. Om pumphjulet är blockerat måste det frigöras manuellt. Ta av det bakersta locket från pumpen och vrid försiktigt på fläkten i plast. Om axeln fortfarande är blockerad, avlägsna fläkten och vrid direkt på axeln. När pumphjulet frigjorts, sätt tillbaka fläkten och

locket.

Preliminära kontroller

1. Kontrollera att eventuella avstängningsventiler på den hydrauliska kretsen är öppna.
2. Om den hydrauliska kretsen är av stängd typ, kontrollera att ett expansionskärl med lämplig kapacitet har installerats. Se paragraf 3.3.3.

Anslutning

1. Koppla vattenkylaren till intags- och avloppsrören. Använd de därför avsedda kopplingarna på baksidan av enheten.
Vi rekommenderar att använda flexibla anslutningar för att ta bort stelheten i systemet.
2. Fyll den hydrauliska kretsen genom att använda den speciella anslutningen placerad på kylarens bakre del ().
3. Tanken är utrustad med en speciell luftventil som måste aktiveras manuellt vid fyllningsögonblicket. Om den hydrauliska kretsen har punkter på högre nivå ska luftningsventiler installeras i dessa punkter.
4. Vi rekommenderar att utrusta inlopps- och utloppsrörssystemen med en kran, för att kunna utesluta maskinen från kretsen vid underhåll.
5. Om kylaren arbetar med öppen tank, ska pumpen installeras på tankens intagssida och vid kylarens tillförsel.



WVarning (modeller 022-120): maskinen är utrustad med en automatisk skyddsanordning för tanken.

Om vatteninloppet oavsiktligt stängs när pumpen är igång och vattenuttaget är öppet, kommer luft in i tanken med trolig ingrepp från nivåsensorn. Det kommer att vara nödvändigt att ventileras den hydrauliska kretsen för att eliminera luften.

Efterföljande kontroller

1. Kontrollera att tanken och kretsen är helt fyllda med vatten och helt tömda på luft.
2. Trycket i den hydrauliska kretsen måste alltid bibehållas. För detta ändamål utför periodiska kontroller och fyll på om nödvändigt, eller så kan du installera ett automatiskt fyllningskit.

Vattnets egenskaper

Om ett nätfiler inte medföljer, installera ett nätfiler på vattenintaget.



vattnets egenskaper

Temperatur	≥50°F (10°C)	CL ⁻	<50 ppm
ΔT IN/OUT	5-15°C	CaCO ₃	70-150 ppm
Max % glykol	50	O ₂	<0.1 ppm
Tryck	43.5-145 PSIG (3-10 barg)	Fe	<0.2 ppm
PH	7.5-9	NO ₃	<2 ppm
Elektrisk ledningsförmåga	10-500 μS/cm	HCO ₃ ⁻	70-300 ppm
Langeliers mättningsindex	0-1	H ₂ S	<0.05 ppm
SO ₄ ²⁻	<50 ppm	CO ₂	<5 ppm
NH ₃	<1 ppm	Al	<0.2 ppm

För särskilda kylvatten (avjoniserat, demineraliserat, destillerat) kan standardmaterialen förutsedda för kondensatorn vara olämpliga. I sådana fall ombedes du kontakta tillverkaren.

3.3.2 Vatten och etylglykol

Om den är installerad utomhus, eller i en stängd ej uppvärmd lokal, är det möjligt att vattnet fryser i kretsen om systemet inte används under de kallaste perioderna av året.

För att minska denna fara:

- utrusta kylaren med lämpliga frysskydd, levererade av tillverkaren som extra tillbehör;
- tömma anläggningen med den speciella tömningsventilen vid längre stopp;
- tillsätta en lämplig mängd kylvätska till cirkulationsvattnet (zie tabel).

Outlet water temperature [°C]	Ethylene glycol (% vol.)	Ambient temperature
4	5	-2
2	10	-5
0	15	-7
-2	20	-10
-4	25	-12
-6	30	-15
-10	40	-20

3.3.3 Expansionskärl

För att undvika möjligheten att en ökning eller minskning av vätskevolymen på grund av en påtaglig temperaturförändring, skadar maskinen eller hydraulkretsen, rekommenderar vi att installera ett expansionskärl med lämplig kapacitet.

Expansionskärlet skall installeras på pumpens intagssida, på tankens bakre koppling.

För en beräkning av minimumvolymen på expansionskärlet att ansluta till en stängd krets kan du använda dig av följande formel:

$$V=2 \times V_{tot} \times (P_{t \text{ min}} - P_{t \text{ max}})$$

där

V_{tot} = tot. volymen på kretsen (i liter)

$P_{t \text{ min/max}}$ = specifik vikt vid minimum/maximumpunkt som vattnet kan uppnå [kg/dm³].

För att bestämma det specifika viktvärdet vid olika temperaturer för glykolprocentsatser, se nedanstående tabell.

% glykol	Temperatur [°C]						
	-10	0	10	20	30	40	50
0%	1.0024	1.0008	0.9988	0.9964	0.9936	0.9905	0.9869
10%	1.0177	1.0155	1.0130	1.0101	1.0067	1.0030	0.9989
20%	1.0330	1.0303	1.0272	1.0237	1.0199	1.0156	1.0110
30%	1.0483	1.0450	1.0414	1.0374	1.0330	1.0282	1.0230
40%	1.0636	1.0594	1.0525	1.0511	1.0461	1.0408	1.0350



Observera: Under påfyllning, referera till tryckvärdena även för expansionskärlet.

Om den omgivande lufttemperaturen vid kylaren är lägre än -10°C måste du flytta expansionstanken till en skyddad omgivning nära kylarens vattenretursida. Säkerhetsventilen och avluftningsventilen måste vara kvar vid kylaren.

3.4 El-krets

3.4.1 Kontroller och anslutningar



Innan du utför något moment på elektriska delar förvissa dig om att maskinen har skilts från elnätet.

Alla elektriska anslutningar måste överensstämma med de lokala föreskrifterna på installationsplatsen.

Initiala kontroller

1. Nätspänningen och nätfrekvensen måste motsvara värdena stämplade på kylarens dataskylt. Matarspänningen får aldrig, inte heller för korta perioder, överskrida toleranserna angivna på det elektriska kopplingsschemat som, med undantag av andra anvisningar, är lika med +/- 10% för spänningen; +/- 1% för frekvensen.
2. Spänningen måste vara symmetrisk (spänningens effektiva värden och fasförskjutningsvinklarna emellan efterföljande faser lika sinsemellan). Max. tillåtna skillnad emellan spänningarna är lika med 2%.

Anslutning

1. Den elektriska strömförsörjningen till kylarna ska ske med en 4-trådig kabel, 3 poler + jord, utan nolledare. Kabelns minsta tvärsnitt specificeras i avsnittet 7.
2. Dra kabeln genom kabelförskruvningen som sitter på maskinens bakre panel och anslut fas och noll till kabelklämmorna på huvudfrånskiljaren (QS), anslut jordkabeln till jordklämmen (PE).
3. Försäkra dig om att matarkabeln vid sitt ursprung har ett skydd mot direkta kontakter minst lika med IP2X eller IPXXB.
4. På den elektriska matarlinjen till kylaren, installera en restströmbrytare med en differential på (RCCB - IDn = 0.3A), för den maximala kapaciteten angiven på det elektriska referenskopplingsschemat, med lämplig brytningskraft för kortslutningsspänningen som existerar i maskinens installationsområde.
Denna magnetströmbrytares nominella ström "In" måste vara lika med FLA och tillslagskurvan måste vara av typ D.
5. Maximal nätimpedans = 0.274 ohm.

Efterföljande kontroller

Förvissa dig om att maskinen och hjälpapparaterna har jordats och skyddats mot kortslutning och/eller överbelastningar.



När enheten en gång har anslutits och huvudströmbrytaren ovanför är stängd (och maskinen således getts spänning), uppnår spänningen i den elektriska kretsen farliga värden. Yttersta försiktighet är nödvändig!



Det är installatörens ansvar att utföra de obligatoriska minimistesterna för att säkerställa korrekt elektrisk installation i enlighet med lokala föreskrifter och i samordning med det relevanta jordningssystemet, inklusive specifika krav för isolerade neutrala system (IT-nät).

3.4.2 Allmänna larm

Alla kylare, är utrustade med ett maskinlarmsignalsystem (se kopplingsschema), bestående av en fri byteskontakt erhållen på uttagsplinten: som gör det möjligt att ansluta ett yttre centraliserat larm, akustiskt, synligt eller ansluten till de logiska enheterna ex. PLC.

3.4.3 Fjärrkontroll ON/OFF

Alla kylaggregat kan anslutas till en fjärrstyrd ON/OFF-kontroll (par.7.):

- För att aktivera fjärrkontrollen rif. n.16387

- Som referensvariabel ON/OFF rif.n.8996

Obs: aktivera inte "Sup" och "Re" tillsammans.

Se det elektriska diagrammet för anslutning av fjärrstyrd ON/OFF (par.7.)

3.5 Vattenversion (W)

Kylare med vattenkondensation har behov av en vattenkrets som leder det kalla vattnet till kondensatorn.

Kylare med vattenkondensation är utrustade med en tryckvaktsventil vid kondensatorns ingång. Tryckvaktsventilens funktion är att reglera det inkommande vattenflödet så att kondensationen alltid hålls på optimal nivå.

Preliminära kontroller

När vattentillförseln till kondensatorn sker via en sluten krets bör samtliga preliminära kontroller som listas för huvudvattenkretsen göras (punkt 3.3.1).

Anslutning

1. Vi rekommenderar att kretsen för kondensationsvattnet utrustas med avstängningsventiler så att maskinen kan isoleras i samband med underhåll.
2. Koppla vattentrycks/returrören till de speciella kopplingarna på baksidan av enheten.
3. Om kondensationsvattnet inte återanvänds rekommenderar vi att kretsen utrustas med ett filter vid intaget till kondensatorn så att risken för nedsmutsning av ytorna reduceras.
4. Omkretsen är sluten, se till att den är ordentligt fylld med vatten och att den avluftas på korrekt sätt.

4 Kontroll

4.1 Kontrollpanel



UPP-knapp: tryck på denna för att öka värdet på en vald, inställbar parameter.



NED-knapp: tryck på denna för att minska värdet på en vald, inställbar parameter.



ESC-knapp: för att avsluta utan att spara; återgår till föregående nivå;
INTRYCKT 5 sek. LARMÅTERSTÄLLNING.



SET-knapp: för att avsluta och spara/bekräfta ett värde, gå till nästa nivå, gå in på Set-meny;
INTRYCKT 5 sek. STARTA KYLAREN.

4.2 Symbolernas betydelse

Symbol	Symbolstatus	Funktion	Symbol	Symbolstatus	Funktion	
	Tänd	Kompressor PÅ		Tänd	Temperaturvärde	
	Blinkar	Kompressor stand_by				
	Av	Kompressor AV				
	Tänd	Larm föreligger		Tänd	Tryckvärde	
	Blinkar	Varning eller Återställbart larm				
	Av	Inget larm				
	Tänd	Pump 1 PÅ		Tänd	Frysnyddsvärmare PÅ	
	Av	Pump 1 Av		Av	Frysnyddsvärmare Av	
	Tänd	Pump 2 PÅ (finns ej)		Tänd	Vevhusvärmare PÅ Kompressor 1	
	Av	Pump 2 Av (finns ej)		Av	Vevhusvärmare Av Kompressor 1	
	Tänd	Pump 2 PÅ (finns ej)		Tänd	Vevhusvärmare PÅ Kompressor 2 (finns ej)	
	Av	Pump 2 Av (finns ej)		Av	Vevhusvärmare Av Kompressor 2 (finns ej)	

4.3 Att starta kylaren

1. Koppla strömförsörjningen till apparaten genom att ställa huvudströmbrytaren QS i läget ON.
2. Tryck på knappen "set" för att starta.
3. Ställ in önskad temperatur på reglarenheten. (avsnitt 4.5.1)

Fasmonitor

Om det vid påslagning av kylarna på displayen visas "E-23"-larm, skall användaren kontrollera att kabelaget dragits korrekt från kopplingsplintar till strömställringångar.

4.3.1 Adjustments at commissioning

1. Temperaturinställning, se kapitlet 4.5.
2. Reglering av pumpen

Verifiera att pumpen fungerar korrekt med hjälp av tryckmätaren (läs av P1 och P0), och kontrollera värdet för tryckgränserna (Pmax och Pmin) som finns på pumpens typskylt.

P1 = Tryck med pumpen ON

P0 = Tryck med pumpen OFF

$P_{min} < (P1 - P0) < P_{max}$

- Exempel nr.1.

Förhållanden:

sluten krets, tryck P0 = 2 bar

värden på pumpens typskylt: Pmin 1 bar/ Pmax 3 bar

justera ventilutloppet till att ge ett tryck om 3 bar < P1 < 5 bar

- Exempel nr.2.

Förhållanden:

öppen krets, tryck P0 = 0 bar

värden på pumpens typskylt: Pmin 1 bar/ Pmax 3 bar

justera ventilutloppet till att ge ett tryck om 1 bar < P1 < 3 bar

3. Kontrollera att pumpen fungerar korrekt på samma sätt under vanliga driftsvillkor. Kontrollera även att pumpens ampere-tal ligger inom de gränser som står på typskylten.
4. Stäng av kylaren och fyll på hydraulsystemet vid "SET"-temperaturen.
5. Kontrollera att temperaturen på det "behandlade" vattnet inte faller till under 5°C, och att omgivningstemperaturen i lokalen där hydraulsystemet arbetar inte faller under 5°C. Om temperaturen är för låg, tillsätt korrekt mängd glykol, enligt anvisningarna under 3.3.3.



OBSERVERA! Innan du slår på kylpumpen ska du stänga vattenutloppets kran (installeras av kunden).

Lämna alltid vatteninloppets kran (installeras av kunden) öppen.

Slå på pumpen och öppna sakta kylvattenutloppets kran och justera flödes hastigheten så som beskrivs under punkt 4.3.1.

4.3.2 Börja med högtemperaturvatten

Om vattentemperaturen i kretsen är hög (till exempel 30-35°C), stäng gradvis (men inte helt, ungefär två tredjedelar!) avstängningsventilen (vilket ska göras av kunden) vid kylaggregatets utlopp för att minska vattenflödet genom enheten. Öppna ventilen gradvis så snart vattentemperaturen sjunker till driftsvärdet.

Viktigt: I detta tillstånd kan flera högtryckslarm utlösas som måste återställas manuellt.

Viktigt: Denna justering förhindrar även vattenslag längs rören på grund av luftfickor i kretsen (luftfickor måste elimineras genom avluftning vid de högsta punkterna i hydraulkretsen, vilket ska göras av kunden).

4.4 AAtt stänga av kylaren

Då kyl drift ej längre krävs, skall kylaren stängas av så som följer: Tryck på knappen "set" (5 Sec.). Stäng inte av huvudströmbrytaren QS - detta för att garantera att frostskyddets anordningar är strömförsörjda.

4.5 Parameterinställningar

Allmänt

Det finns två skydds nivåer för parametrarna:

- Direkt User-(U): med omedelbar tillgång, **Förändringsbar av användaren**;
- Lösenordsskyddad Service-(S): lösenord krävs för tillgång, **(skall ej ändras)**.

4.5.1 Kylarparametrar (CF9)

PARAMETER	KOD	TYP	DEFAULT
Måttenhet.	R1	U	OFF
Larmrelähantering	CFJ1	U	0
Återställa standardparametrar	DEF	U	OFF
Fjärrläge på / av aktivering	R7	U	0
Programversion	UER	U	1.7.0
Enhetsadress	CF30	U	1
Överföringshastighet	CF31	U	3
Modbus-protokoll	CF32	U	1
Övervakare på / av aktivering	SUP	U	OFF
Dynamisk aktivering av inställningspunkt	Erd	U	OFF

4.5.2 Temperaturstyrning (CTP)

PARAMETER	KOD	TYP	DEFAULT
Temperaturstyrningens inställningspunkt (standard)	SET	U	13.0
Temperaturstyrningens inställningspunkt (precisionskontroll)	SET	U	20.0
Temperaturstyrningens differential (finns EJ i konfiguration "precisionskontroll")	DIFF1	U	4.0

4.5.3 Underhållsparametrar (Pnt)

PARAMETER	KOD	TYP	DEFAULT
Enhet arbetstimmar	UH	U	-
Enhet arbetstimmar (X1000)	UHL	U	-
Enhet partiella arbetstimmar	UPH	U	-
Enhet partiella arbetstimmar (X1000)	UPHL	U	-
Kompressor arbetstimmar 1	CIH	U	-
Kompressor arbetstimmar 1 (x1000)	CIHL	U	-

4.5.4 Prob parametrar (bt 1, bt2)

Prob (bt 1)

PARAMETER	KOD	TYP	DEFAULT
Högtemperaturlarm (vatten)	HR1	U	60

Prob (bt2)

PARAMETER	KOD	TYP	DEFAULT
Högtemperaturlarm (vatten)	HR2	U	60

4.5.5 Larmhistorik (ALH 1)

PARAMETER	KOD	TYP	DEFAULT
Larmnummer	HYS1	U	-
Se larmkod	HYS2	U	-
Se dag och månad för larm	HYS3	U	-
Se timme och minut för larm	HYS4	U	-
bt1 temperatur vid tiden för larm	HYS5	U	-
bt2 temperatur vid tiden för larm	HYS6	U	-
STÄLLDA villkor vid tiden för larm	HYS7	U	-

4.6 Ändra parametrar (User)

4.6.1 Kylarparametrar "CF9"

Måttenhet.

Slå på kylaren "ON" med huvudfrånskiljaren QS och vänta tills indikationen "OFF" visas på displayen. Tryck samtidigt på knapparna "esc" och "set" för att gå in på "U"-parametrarna.	
Parameter "PAr" visas. Tryck på knappen "set" för att föra in.	
Parameter "CF9" visas. Tryck på knappen "set" för att föra in.	
Parameter "A I" visas. Tryck på knappen "set" för att föra in	
Standardvärdet är "0FF" = °C Använd knapparna "down" och "up" för att välja måttenhet. 0FF : temperatur = C°, Celsius ; tryck = Bar; P : temperatur = °F, Fahrenheit; Tryck =PSI	
Tryck på knappen "set" för att bekräfta.	
Gå automatiskt tillbaka till "A I" Parametern har nu lagrats. Tryck på knappen "esc" för att avsluta, tre gånger.	

Larmhantering

Slå på kylaren "ON" med huvudfrånskiljaren QS och vänta till indikationen "OFF" visas på displayen. Tryck samtidigt på knapparna "esc" och "set" för att gå in på "U"-parametrarna.	
Parameter "PAr" visas. Tryck på knappen "set" för att föra in.	
Parameter "CF9" visas. Tryck på knappen "set" för att föra in.	
Parameter "A I" visas. Använd knapparna "down" och "up" för att välja "CFJ I"-parameter.	
Tryck på knappen "set" för att föra in.	
Standardvärdet är "0" Använd knapparna "down" och "up" för att välja larmrelähantering (par. 4.5.1- Tab.1)	
Tryck på knappen "set" för att bekräfta.	
Gå automatiskt tillbaka till "CFJ I" Parametern har nu lagrats. Tryck på knappen "esc" för att avsluta, tre gånger.	

Tab.1 Larmrelähantering (CFJ I.)

0	Reläet normalt avslaget, slås på av ett larm.
1	Reläet normalt påslaget (även med styrningen OFF), stängs av vid ett larm.
2	Reläet normalt påslaget (endast med styrningen ON), stängs av vid ett larm eller med styrningen OFF.

Standardparametrar

Slå på kylaren "ON" med huvudfrånskiljaren QS och vänta till indikationen "OFF" visas på displayen. Tryck samtidigt på knapparna "esc" och "set" för att gå in på "U"-parametrarna.	
Parameter "PAR" visas. Tryck på knappen "set" för att föra in.	
Parameter "CF9" visas. Tryck på knappen "set" för att föra in.	
Parameter "A1" visas. Använd knapparna "down arrow" och "up arrow" för att välja "dEF"-parameter.	
Tryck på knappen "set" för att föra in.	
Standardvärdet är "OFF". Använd knapparna "down arrow" och "up arrow" för att ändra från "OFF" till "0n".	
Tryck på knappen "set" för att bekräfta.	
Efter några få sekunder går du tillbaka till "OFF". Parametrarna återställdes automatiskt. Tryck på knappen "esc" för att avsluta, tre gånger.	







Fjärr ON/OFF

Slå på kylaren "ON" med huvudfrånskiljaren QS och vänta tills indikationen "OFF" visas på displayen. Tryck samtidigt på knapparna "esc" och "set" för att gå in på "U"-parametrarna.	
Parameter "PAR" visas. Tryck på knappen "set" för att föra in.	
Parameter "CF9" visas. Tryck på knappen "set" för att föra in.	
Parameter "A1" visas. Använd knapparna "down arrow" och "up arrow" för att välja "A7"-parameter.	
Tryck på knappen "set" för att föra in.	
Standardvärdet är "0". Använd knapparna "down arrow" och "up arrow" för att välja läge: (par. 4.5.1- Tab.2)	
Tryck på knappen "set" för att bekräfta.	
Gå automatiskt tillbaka till "A7". Parametern har nu lagrats. Tryck på knappen "esc" för att avsluta, tre gånger.	



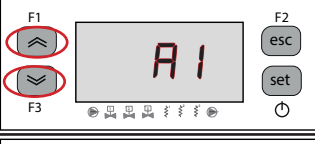



Tab. 2 Fjärrläge På / Av (A7)

0	Fjärrläge På/Av avstängt
1	Fjärrläge På/Av påslaget tillsammans med lokal På/Av. Vid strömavbrott, eller om huvudströmbrytaren stängs av, måste kylaren återstartas lokalt då strömmen kommer tillbaka
2	Endast Fjärrläge På/Av, lokal På/Av avstängd

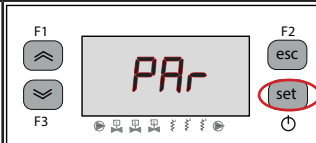
Programversion (skrivskyddad)

Slå på kylaren "ON" med huvudfrånskiljaren QS och vänta tills indikationen "OFF" visas på displayen. Tryck samtidigt på knapparna "esc" och "set" för att gå in på "U"-parametrarna.	
Parameter "PAR" visas. Tryck på knappen "set" för att föra in.	
Parameter "CF9" visas. Tryck på knappen "set" för att föra in.	
Parameter "A i" visas. Använd knapparna "down arrow" och "up arrow" för att välja "UEr"-parameter.	
Tryck på knappen "set" för att föra in.	
Programversionen visas	
Tryck på knappen "esc" för att avsluta, tre gånger.	

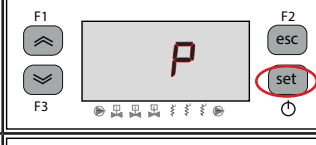
Aktivering av övervakare

Slå på kylaren "ON" med huvudfrånskiljaren QS och vänta till indikationen "OFF" visas på displayen. Tryck samtidigt på knapparna "esc" och "set" för att gå in på "U"-parametrarna.	
Parameter "PAR" visas. Tryck på knappen "set" för att föra in.	
Parameter "CF9" visas. Tryck på knappen "set" för att föra in.	
Parameter "A i" visas. Använd knapparna "down arrow" och "up arrow" för att välja "SUP"-parameter.	
Tryck på knappen "set" för att föra in.	
Standardvärdet är "OFF" Använd knapparna "down arrow" och "up arrow" för att ändra.	
Tryck på knappen "set" för att bekräfta.	
Parametern har nu lagrats. Tryck på knappen "esc" för att avsluta, tre gånger.	

Modbus (adress)

Slå på kylaren "ON" med huvudfrånskiljaren QS och vänta tills indikationen "OFF" visas på displayen. Tryck samtidigt på knapparna "esc" och "set" för att gå in på "U"-parametrarna.	
Parameter "PA _r " visas. Tryck på knappen "set" för att föra in.	
Parameter "CF ₉ " visas. Tryck på knappen "set" för att föra in.	
Parameter "A _i " visas. Använd knapparna "down" och "up" för att välja "CF30"-parameter.	
Tryck på knappen "set" för att föra in.	
Standardvärdet är "1" Använd knapparna "down" och "up" för att ändra adress.	
Tryck på knappen "set" för att bekräfta.	
Parametern har nu lagrats. Tryck på knappen "esc" för att avsluta, tre gånger.	









Modbus (protokoll)

Slå på kylaren "ON" med huvudfrånskiljaren QS och vänta tills indikationen "OFF" visas på displayen. Tryck samtidigt på knapparna "esc" och "set" för att gå in på "U"-parametrarna.	
Parameter "PA _r " visas. Tryck på knappen "set" för att föra in.	
Parameter "CF ₉ " visas. Tryck på knappen "set" för att föra in.	
Parameter "A _i " visas. Använd knapparna "down" och "up" för att välja "CF31"-parameter.	
Tryck på knappen "set" för att föra in.	
Standardvärdet är "1" Använd knapparna "down" och "up" för att ändra protokollet. (par. 4.5.1- Tab.3)	
Tryck på knappen "set" för att bekräfta.	
Parametern har nu lagrats. Tryck på knappen "esc" för att avsluta, tre gånger.	

Tab.3 Protokoll modbus (tillval) (CF31)

1	JÄMN	2	INGEN	3	UDDA
---	------	---	-------	---	------

Modbus (överföringshastighet)









Slå på kylaren "ON" med huvudfrånskiljaren QS och vänta tills indikationen "OFF" visas på displayen. Tryck samtidigt på knapparna "esc" och "set" för att gå in på "U"-parametrarna.	
Parameter "PAR" visas. Tryck på knappen "set" för att föra in.	
Parameter "CF9" visas. Tryck på knappen "set" för att föra in.	
Parameter "A1" visas. Använd knapparna "↓" och "↑" för att välja "CF32"-parameter.	
Tryck på knappen "set" för att föra in.	
Standardvärdet är "3" Använd knapparna "↓" och "↑" för att ändra överföringshastigheten. (par. 4.5.1- Tab.4)	
Tryck på knappen "set" för att bekräfta.	
Parametern har nu lagrats. Tryck på knappen "esc" för att avsluta, tre gånger.	

Tab. 4 Överföringshastighet (tillval) (CF32)

1	2400	3	9600	5	38400	7	115200
2	4800	4	19200	6	57600		

 Anmärkning: Om du ändrar MODBUS-parametrarna måste du för att validera de nya parametrarna stänga AV kylaren och sedan sätta PÅ den igen.









ERD aktivering

Slå på kylaren "ON" med huvudfrånskiljaren QS och vänta tills indikationen "OFF" visas på displayen. Tryck samtidigt på knapparna "esc" och "set" för att gå in på "U"-parametrarna.	
Parameter "PAR" visas. Tryck på knappen "set" för att föra in.	
Parameter "CF9" visas. Tryck på knappen "set" för att föra in.	
Parameter "A1" visas. Använd knapparna "↓" och "↑" för att välja "Erd"-parameter.	
Tryck på knappen "set" för att föra in.	
Standardvärdet är "OFF" Använd knapparna "↓" och "↑" för att ändra.	
Tryck på knappen "set" för att bekräfta.	
Parametern har nu lagrats. Tryck på knappen "esc" för att avsluta, tre gånger.	

 Med ERD-parameter aktivera: Ändring av den inställda vattentemperaturen med hänsyn till omgivningstemperaturen. Funktionen är endast aktiv om precisionsstyrningen av temperaturen är inaktiverad (CPT=AV).









4.6.2 Temperaturstyrning "CNP"

Inställning av temperaturstyrningen

Slå på kylaren "ON" med huvudfrånskiljaren QS och vänta tills indikationen "OFF" visas på displayen. Tryck samtidigt på knapparna "esc" och "set" för att gå in på "U"-parametrarna.	
Parameter "PAR" visas. Tryck på knappen "set" för att föra in.	
Parameter "CF9" visas. Använd knapparna "v" och "u" för att välja "CNP"-parameter.	
Tryck på knappen "set" för att föra in.	
Parameter "SEt" visas. Tryck på knappen "set" för att föra in.	
Standardvärdet är "13.0" Använd knapparna "v" och "u" för att ändra värdet.	
Tryck på knappen "set" för att bekräfta.	
Parametern har nu lagrats. Tryck på knappen "esc" för att avsluta, tre gånger.	

Viktigt: Inställning av temperaturen mellan 1 °C och 5 °C måste utföras av specialiserade tekniker som måste använda den särskilda servicemanualen för denna produkt.

Reglering av temperaturdifferentialen

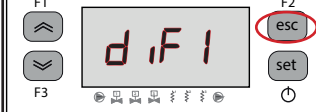
Slå på kylaren "ON" med huvudfrånskiljaren QS och vänta tills indikationen "OFF" visas på displayen. Tryck samtidigt på knapparna "esc" och "set" för att gå in på "U"-parametrarna.	
Parameter "PAR" visas. Tryck på knappen "set" för att föra in.	
Parameter "CF9" visas. Använd knapparna "v" och "u" för att välja "CNP"-parameter.	
Tryck på knappen "set" för att föra in.	
Parameter "SEt" visas. Använd knapparna "v" och "u" för att välja "dIF I"-parameter.	
Tryck på knappen "set" för att föra in.	
Standardvärdet är "4.0" Använd knapparna "v" och "u" för att ändra värdet.	
Tryck på knappen "set" för att bekräfta.	
Parametern har nu lagrats. Tryck på knappen "esc" för att avsluta, tre gånger.	

4.6.3 Prob parameter "bt 1"

Prob "bt 1".

Slå på kylaren "ON" med huvudfrånskiljaren QS och vänta tills indikationen "OFF" visas på displayen. Tryck samtidigt på knapparna "esc" och "set" för att gå in på "U"-parametrarna.	
Parameter "PAr" visas. Tryck på knappen "set" för att föra in.	
Parameter "CF9" visas. Använd knapparna "v" och "u" för att välja "bt 1"-parameter.	
Tryck på knappen "set" för att föra in.	
Parameter "HA 1" visas. Tryck på knappen "set" för att föra in.	
Standardvärdet är "60.0" Använd knapparna "v" och "u" för att ändra värdet.	
Tryck på knappen "set" för att bekräfta.	
Parametern har nu lagrats. Tryck på knappen "esc" för att avsluta, tre gånger.	

Samma sekvens för prob "bt2".

4.7 Visning av sensor/ fläkt/ kompressor

Kylare i drift. Tryck på knappen "u" för att se proberna bt 1, bt 2, bt 3, bP 1.....	
Välj prob och vänta några sekunder. (T.ex. BT2)	
Värdet för proben bt 2 visas.	
Vi rekommenderar att alltid gå tillbaka till prob bt 1	

Beskrivning:

- bt 1 : temperatursond för utloppsvatten
- bt 2 : evaporatortemperatursond
- bt 3 : sond för omgivningstemperat
- bt 10 : temperatursond för Elpanelens (option)
- bP 1 : krets 1 sändaret
- bP 2 : krets 1 sändaret; (från modell ICEP080)









F_ : fläktdrift:



- F_ : fläkt AV
- F- : fläkt 1 PÅ, fläkt 2,3 AV: (2 = från modell ICEP022) (3 = från modell ICEP080)
- F-- : fläkt 1 och 2 PÅ, fläkt 3 AV, (2 = från modell ICEP022) (3 = från modell ICEP080)
- F--- : fläkt 1,2 och 3 PÅ (från modell ICEP080)

ICE : kompressorernas drift:

- ICE : kompressorer inaktiverade
- ICE- : kompressorer AV
- ICE- : kompressor 1 PÅ, kompressor 2 AV
- ICE : kompressorer 1 och 2 PÅ; (från modell ICEP055)
- ICE- : med blinkande "1" kompressor redo att starta, kompressor 2 AV

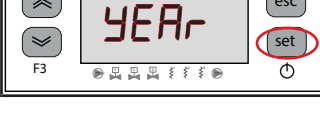







4.8 Ställa in klocka/datum

Slå på kylaren "ON" med huvudfrånskiljaren QS och vänta tills indikationen "OFF" visas på displayen. Tryck samtidigt på knapparna "⏪" och "⏩" för att gå in på "Datum/tid"-menyn.	
Parameter "FrEE" visas. Tryck på knappen "set" för att föra in.	
Parameter "R ." visas. Använd knapparna "⏪" och "⏩" för att välja "CL"-parameter.	
Tryck på knappen "set" för att föra in.	
Parameter "HOUr" visas. Tryck i 5 sekunder på knappen "set". Nu blinkar parametern.	
Använd knapparna "⏪" och "⏩" för att välja datum, tid eller år som ska ändras.	
Tryck på knappen "set" för att föra in.	
Använd knapparna "⏪" och "⏩" för att ändra värdet (t.ex. år)	
Tryck på knappen "set" för att bekräfta.	

Använd knapparna "⏪" och "⏩" för att ändra ett annat värde (t.ex. datum)	
Tryck på knappen "esc" för att avsluta. Parametern slutar blinka.	
Tryck samtidigt på knapparna "⏪" och "⏩" för att avsluta.	

⚠ Minnet för Klocka/Datum har en maximal varaktighet på tre dagar, så om kontrollenheten lämnas utan ström under längre tid kommer alla inmatade data angående timme/månad/år att förloras. Justera klockan vid start av maskinen, och närhelst så är nödvändigt.

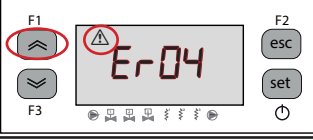



4.9 Larmhantering

<p>Om ett larm föreligger visas larmkoden och en symbol överst till vänster</p> <p> Kontinuerlig = larm föreligger Blinkande = varning föreligger/återställbart larm</p>	
<p>Tryck på knappen "set" för att föra in.</p>	
<p>Parameter "ALH" visas.</p> <p>Tryck på knappen "" för att välja "AL"-parameter.</p>	
<p>Tryck på knappen "set" för att föra in.</p>	
<p>Larmets kod visas t.ex.: "Er04".</p> <p>Tryck på knappen "" för att kontrollera om flera larm föreligger.</p>	
<p>Reparera felet innan återställning utförs.</p> <p>När felet har reparerats börjar larmsymbolen blinka.</p> <p>Nu kan du utföra återställning.</p>	
<p>Tryck på knappen "esc" tills larmet försvinner.</p>	

Lista över larm/varningar

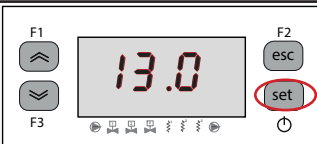
Kod	Beskrivning	Åtgärd	Återställ
Er01	Sensor bt1 urkopplad eller sönder	Larm	M
Er02	Sensor bt2 urkopplad eller sönder	Larm	M
Er03	Sensor bt3 urkopplad eller sönder	Larm	A
Er05	Sensor bt10 urkopplad eller sönder	Larm	A
Er06	Sensor bP1 urkopplad eller sönder	Larm	M
Er08	Högtrycksbrytare krets 1	Larm	M
Er09	Lågtrycksbrytare krets 1	Larm	M
Er12	Hög temperatur bt1	Larm	M
Er13	Låg temperatur bt1	Larm	A
Er14	Hög temperatur bt2	Larm	M
Er15	Låg temperatur bt2	Larm	M
Er16	Hög temperatur bt3	Larm	A
Er17	Låg temperatur bt3	Larm	A
Er18	Termiskt kompressorskydd 1	Larm	M
Er20	Termiskt pumpskydd 1	Larm	M
Er22	Låg vattennivå/differentialtrycksbrytare	Larm	M
Er23	Fasmonitor	Larm	M
Er24	Expansion sönder eller fränkopplad	Larm	M
Er25	Överstigen drifttid för kompressor 1	Varning	M
Er27	Överstigen drifttid för enheten	Varning	M
Er28	Klockminne	Varning	A
Er29	Kylarkonfiguration	Varning	A





4.10 Larmhistorik

Kylare i drift. Tryck på knappen "set" för att se larmhistoriken.	
Tryck på knappen "set" för att föra in.	
Använd knapparna "⏪" och "⏩" för att se parametrarna. (Par. 4.5.5)	
Tryck på knappen "set" för att se värdet.	

5 Underhåll

- Maskinen är formgiven och tillverkad för att garantera en kontinuerlig funktion. Komponenternas hållbarhet är dock direkt beroende av det underhåll de får.
-  Vid begäran om service eller reservdelar, identifiera maskinen (modell och serienummer) med hjälp av uppgifterna på dataskylten som finns på utsidan av enheten. (www.polewr.com)

5.1 Allmän information

-  Kontrollera att spänningen till kylaren inte är på innan någon typ av underhåll görs.
-  Använd alltid original reservdelar från tillverkaren. Om original reservdelar inte används accepterar tillverkaren inget ansvar för funktionsstörningar på maskinen.
-  Vid kylmedelsläckage, kontakta en auktoriserad fackman.
-  Schraderventilen skall endast användas vid funktionsstörningar på maskinen. I annat fall godkänns inte skadorna orsakade av en felaktig påfyllning av kylmedel inom ramen för garantin.

5.2 Kylmede













Påfyllning: eventuella skador som orsakas av felaktigt utförd påfyllning av icke auktoriserad personal godkänns inte inom ramen för garantin. 

-  Apparaten innehåller fluorerad växthusgas. Kylvätskan R513A är vid normal temperatur och normalt tryck en ofärgad gas tillhörande SAFETY GROUP A1 - EN378 (vätskegrupp 2 enligt direktiv PED 2014/68/EU); GWP (Global Warming Potential) = 629.

 In case of refrigerant leakage, air the room.

5.3 Program för förebyggande underhåll

Gör följande för att garantera att kylaren blir maximalt effektiv och tillförlitlig:

Beskrivning av underhållsåtgärder	Underhållsintervall (vid standard funktionsvillkor)				
	Åtgärd	Daily	6 Months	12 Months	36 Months
kontrollera  Service 					
Kontrollera att kontrolllampan POWER ON lyser.					
Kontrollera indikatorerna på kontrollpanelen.					
Rengör kondensatorns flänsar.					
Kontrollera den upptagna effekten.					
Kontrollera att det inte finns kylmedelsläckor.					
Kontrollera och Rengör Säkerhetsventil vatten (om sådan finns)*					
Kontrollera elsystemet och elpanelen**					
Kontrollera temperatursonderna. Byt vid behov.				 	
Maintenance kit					

 Följande kan beställas (se avsnitt 7.):

- a) servicesats: elektrisk sats; kompressorsats; fläksats; förångareats; pumpats; vattentankats;
- b) lösa reservdelar.

*För att säkerställa full effektivitet måste säkerhetsventilerna kontrolleras regelbundet.

Med tiden kan orenheter ansamlas nära pluggen, därför är regelbunden spolning av ventilensätet nödvändigt. Sådan spolning utförs genom att tömma ventilen manuellt, genom att vrida vredet i pilarnas riktning.

Viktigt: Se till att drifttrycket återställs efter denna åtgärd.

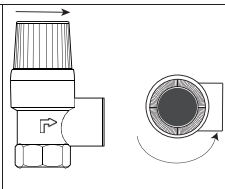



** Under det regelbundna underhållet måste elsystemet på maskinen och elpanelen också kontrolleras i enlighet med lokal lagstiftning. Dessutom bör en visuell inspektion av utrustningen och elektriska ledare alltid utföras där det är möjligt. Det är även nödvändigt att kontrollera korrekt åtdragning av effektkomponenternas kopplingsplintar enligt de åtdragningsmoment som anges i elschemat.

5.4 Isärtagning

Kylvätskan och smörjoljan som finns i kretsen måste återvinnas enligt gällande lokala miljöbestämmelser.

Återvinningen av kylmedel är utförd före den slutgiltiga förstöringen av apparaten ((EU) Nr 517/2014 art.8).

	ÅTERVINNING ELIMINERING 
Snickerier	Stål/Epoxyhartser, polyester
Tank	Aluminium/Koppar/Stål
Rör/kollektorer	Koppar/Aluminium/Kolstål
Rörisolering	Nitrilgummi (NBR)
Kompressor	Stål/Koppar/Aluminium/olja
Kondensator	Stål/Koppar/Aluminium
Pump	Stål/Gjutjärn/Mässing
Fläkt	Aluminium
Kylmedel	R513A
Ventiler	Mässing/Koppar
Elektriska kablar	Koppar/PVC

Utrustning som innehåller elektriska komponenter måste kasseras separat med elektriskt och elektroniskt avfall enligt lokal och aktuell lagstiftning.



6 Felsökning

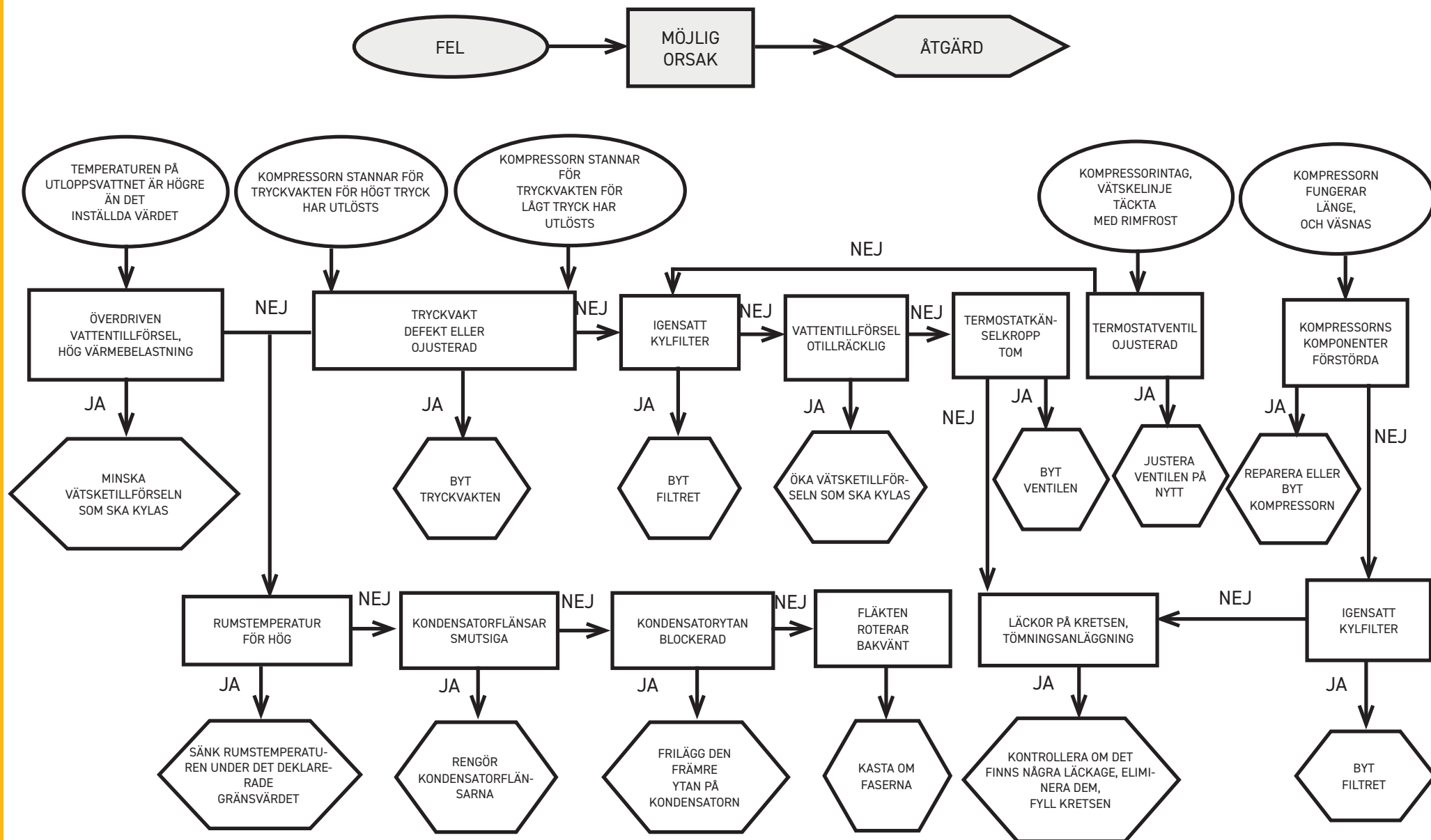

1 Turvallisuuohjeet	2
1.1 Käyttöohjeiden käyttö.....	2
1.2 Varoitusmerkit.....	2
1.3 Turvallisuuohjeet.....	2
1.4 Muut vaarat.....	2
2 Johdanto	3
2.1 Kuljetus.....	3
2.2 Laitteen siirtäminen.....	3
2.3 Tarkastus.....	3
2.4 Varastointi.....	3
3 Asennus	3
3.1 Asennuksen vaatima tila.....	3
3.2 Mallit.....	3
3.3 Hydrauliiikkapiiri.....	3
3.3.1 Tarkistukset ja liitännät.....	3
3.3.2 Vesi ja etyleeniglykoli.....	4
3.3.3 Paisuntasäiliö.....	4
3.4 Sähkövirtapiiri.....	5
3.4.1 Tarkistukset ja liitännät.....	5
3.4.2 Yleishälytys.....	5
3.4.3 Etäkäynnistys/-pysäytys.....	5
3.5 Vedellä toimiva kuivainmalli(W).....	5
4 Ohjaus	6
4.1 Ohjauspaneeli.....	6
4.2 Symboleiden merkitys.....	6
4.3 Jäähdyttimen käynnistäminen.....	6
4.3.1 Käyttöönnotossa tehtävät säädöt.....	6
4.3.2 Aloittaminen korkean lämpötilan vedellä.....	6
4.4 Jäähdyttimen pysäyttäminen.....	7
4.5 Parametrien asetukset.....	7
4.5.1 Jäähdyttimen parametrit (CF9).....	7
4.5.2 Lämpötilan säätö (CNP).....	7
4.5.3 Huollon parametrit (PnE).....	7
4.5.4 Anturin parametrit (bE 1, bE2).....	7
4.5.5 Hälytyshistoria (RLH 1).....	7
4.6 Parametrien muuttaminen (User).....	8
4.6.1 Jäähdyttimen parametrit (CF9).....	8
4.6.2 Lämpötilan säätö (CNP).....	13
4.6.3 Anturin parametri bE 1.....	14
4.7 Näyttö anturi/ puhallin/ Kompressorin.....	14
4.8 Kellonajan/päivämäärän asettaminen.....	15
4.9 Hälytysten hallinta.....	16
4.10 Hälytyshistoria.....	17
5 Huolto	17
5.1 Yleisiä varoituksia.....	17
5.2 Jäähdytysaine.....	17
5.3 Ennakoiva huolto.....	18
5.4 äteöljyn ja -nesteiden hävittäminen.....	18

7 Liitteet





7.1 Merkkien selitykset
7.2 Asennuskaavio
7.3 Laitteen siirtäminen - Asennuksen vaatima tila
7.4 Tekniset tiedot
7.5 Mitat
7.6 Varaosaluettelo
7.7 Räjätyskuvat
7.8 Piirikaavio
7.9 Sähkökaavio

1 Turvallisuusohjeet

1.1 Käyttöohjeiden käyttö

- Säilytä käyttöohjeet tallessa koko laitteen käyttöajan ajan.
- Lue käyttöohjeet ennen kuin aloitat mitään toimenpiteitä.
- Oikeus muutoksiin pidätetään. Ajan tasalla olevat tiedot löytyvät laitteen mukana toimitetusta käsikirjasta.

1.2 Varoitusmerkit

	Henkilövahinkojen vaara.
	Nouda ohjetta välttääksesi laitevahingot.
	Tarvitaan ammattitaitoisen ja valtuutetun huoltoteknikon toimenpiteitä.
	Symbolit on selitetty kohdassa 7.

1.3 Turvallisuusohjeet

 Jokaisessa yksikössä on päävirtakytkin virran katkaisemista varten, jotta huoltotoimenpiteet voidaan suorittaa turvallisesti. Virta on kytkettävä pois päävirtakytkimestä aina huoltotöiden ajaksi.

 Käyttöohjekirjan sisältämät tiedot on tarkoitettu laitteen käyttäjälle vain siinä määrin kuin toimenpiteet voidaan suorittaa suojapaneeleja avaamatta. Kaikki sellaiset toimenpiteet Asennus/tehtävät säädöt/ huolto joissa suojapaneelit tarvitaan avata työkalujen avulla, on jätettävä ammattitaitoisen ja koulutetun henkilöstön tehtäväksi.

 Asennettavaksi ainoastaan paikkoihin, joihin yleisöllä ei ole pääsyä joko turvalliseen paikkaan, johon on rajoitettu pääsy, vähintään 2,5 metrin korkeuteen tai suojatuille kattoalueille, ellei heidän turvallisuudestaan vastaava henkilö ole valvonut tai antanut heille ohjeita laitteen käytöstä.



 Asennusetäisyys seinästä ja vapaa käyttötila on ilmoitettu kappaleessa 7.3.

 Huomio: nouda kappaleessa 7.4 ilmoitettuja min./max. lämpötila- ja painerajoja sekä kappaleessa 7.2 ilmoitettua kokonaiskäyttölämpötila-alueetta.

 Kaikki yksiköt voitiin asentaa ulos.

 Kaikkien sähköliitännöiden tulee vastata asennuspaikan vaatimia paikallisia määräyksiä.

 Älä ylitä arvokilvessä mainittuja mitoitusarvoja.

  Käyttäjän vastuulla on välttää kuormituksia, jotka eroavat sisäisestä staattisesta paineesta. Mikäli seismisten vaikutusten riski on olemassa, yksikkö on suojattava asianmukaisesti. Yksikköä saa käyttää ainoastaan ammattikäytössä ja sen käyttötarkoitusta vastaavasti.

 Käyttäjän vastuulla on tutkia kaikki siihen käyttökohteeseen liittyvät näkökohdat, johon tuote on asennettu, noudattaa kaikkia sovellettavissa olevia teollisuuden turvastandardeja sekä kaikkia käyttöohjeen ja yksikön mukana toimitettujen muiden asiakirjojen sisältämiä tuotetta koskevia määräyksiä. Osien käsittely tai vaihto muun kuin valtuutetun henkilöstön toimesta ja/tai yksikön epäasianmukainen käyttö vapauttavat valmistajan kaikesta vastuusta ja aiheuttavat takuun raukeamisen. Valmistaja ei vastaa millään tavalla henkilö-, omaisuus- tai laitevahingoista, jotka ovat aiheutuneet käyttäjien huolimattomuuden tai oheisten käyttöohjeiden tai laitteeseen liittyvien turvallisuusmääräysten noudattamisen laiminlyönnin vuoksi. Valmistaja ei vastaa mahdollisista vahingoista, jotka ovat aiheutuneet pakkaukseen tehtyjen muutosten vuoksi. Käyttäjän vastuulla on varmistaa, että yksikön tai sen osien ja/tai lisävarusteiden valintaa varten toimitetut tekniset tiedot ovat riittävän kattavia yksikön tai sen osien odotettavissa olevan asianmukaisen tai järkevän käytön tarkoituksessa.

 **HUOMIO: Valmistaja pidättää oikeuden muuttaa oheisen käsikirjan tietoja ilman etukäteisilmoitusta. Täydelliset ja päivitettyt käyttöohjeet ja tiedot löytyvät laitteen mukana toimitetusta käsikirjasta.**

1.4 Muut vaarat

Laitteen asennus, käynnistys, sammutus ja huolto on ehdottomasti suoritettava mukana toimitettujen teknisten asiakirjojen ja ohjeiden mukaisesti sekä lisäksi huolehtien siitä, että minkäänlaisia vaaratilanteita ei pääse syntymään.

Vaarat, joita ei ole voitu poistaa suunnittelun keinoin, on esitetty seuraavassa taulukossa..

laitteen osa	vaara	tilanne	varotoimet
lämmönvaihdin	leikkautumisen aiheuttamat haavat	kosketus	vältä koskettamasta, käytä suojakäsineitä
tuulettimen ritilä ja tuuletin	vammat	terävien esineiden työntäminen ritilän aukkoihin tuulettimen käydessä	älä työnnä minkäänlaisia esineitä tuulettimien ritilöiden sisään tai laita mitään ritilöiden päälle
laitteen sisäpuoli: kompressori ja syöttöputki	palovammat	kosketus	vältä koskettamasta, käytä suojakäsineitä
laitteen sisäpuoli: metalliosat ja sähköjohdot	myrkytys, vaarallinen sähköisku, vakavat palovammat	sähkönsyöttökaapeleiden eristyksen vika jännitteellisissä osissa sähkökaapin jälkeen	syöttölinjan asianmukainen sähkösuojaus; erittäin huolellinen metalliosien maadoitus

laitteen osa	vaara	tilanne	varotoimet
laitteen ulkopuoli: laitteen ympäristö	myrkytys, vakavat palovammat	oikosulun aiheuttama tulipalo tai syöttölinjan ylikuumentuminen yksikön sähkökaapin jälkeen	kaapelien läpimittojen ja sähkönsyöttölinjan suojajärjestelmän tulee olla voimassa olevien määräysten mukaisia

2 Johdanto

Kompressorin, pumpun ja tuulettimen moottoreissa on lämpösuojaus, joka estää niiden ylikuumentumisen.

2.1 Kuljetus

Pakkauksessaan oleva laite on pidettävä:

- pystyasennossa;
- suojattuna sään vaikutuksilta;
- suojattuna törmäyksiltä ja iskuilta.

2.2 Laitteen siirtäminen

Käytä laitteen siirtämisessä haarukkatrukkia, jonka nostovoima on riittävä nostettavaan painoon nähden. Estä kaikenlaiset kolhut ja törmäykset.

2.3 Tarkastus

- Kaikille laitteille on suoritettu tehtaalla kokoonpano, kaapelointi, jäähdytysaineen ja öljyn täyttö sekä tarkastus.
- Tarkista laitteen kunto vastaanoton yhteydessä. Jos havaitset vahinkoja, tee välittömästi vahinkoilmoitus kuljetusliikkeelle.
- Pura laite pakkauksestaan mahdollisimman lähellä asennuspaikkaa.

2.4 Varastointi

- Säilytä laite pakkauksessaan puhtaassa tilassa suojattuna kosteudelta ja sään vaikutuksilta.
- älä sijoita yksiköitä päällekkäin;
- noudata pakkaukseen merkittyjä ohjeita.

3 Asennus

 Noudata asennuksessa ohjeita, jotka on mainittu kohdissa.7.

 Asennetun tuotteen on oltava asianmukaisesti suojattu palovaaraa vastaan (viite EN378-3)..

 **Kaikkiin jäädyttimiin on suositeltavaa asentaa riittävä esisuodatin lähelle jäädyttimen syöttöliitäntää (suodatusastetta: min.05mm; max1.0mm).**

 **Jäädytettävät nesteet**

Jäädytettävien nesteiden tulee olla yhteensopivia laitteen valmistusmateriaalien kanssa.

Esimerkkejä käyttökelpoisista nesteistä ovat **vesi tai veden ja etyleeni- tai propyleeniglykolin seokset**.

Jäädytettävät nesteet eivät saa olla tulenarkoja.

Jos jäädytettävä neste sisältää haitallisia aineita (kuten esimerkiksi etyleeni-/propyleeniglykoli), mahdolliset vuodot on kerättävä talteen, sillä neste on haitallista ympäristölle. Hydraulikkaputkiston tyhjennys tulee suorittaa noudattaen voimassa olevia määräyksiä. Hydraulikkaneiteitä ei saa päästää ympäristöön.

3.1 Asennuksen vaatima tila

 **Jätä laitteen ympärille 1,5 metriä tilaa.**

Jätä vähintään 2 metriä tilaa jäädyttimen yläpuolelle malleissa, joissa lauhdeilman poisto on pystysuuntainen.

3.2 Mallit

Aksiaaliset tuulettimet (A)

Vältä jäähdytysilman kiertoa. Älä tuki ilmanvaihtoritilöitä.

Aksiaalituulettimilla varustetuissa malleissa poistoilmakanavan asennus ei ole suositeltavaa.

3.3 Hydraulikkapiiri

3.3.1 Tarkistukset ja liitännät

 Tarkista ennen jäädyttimen kytkentää ja piirin täyttöä, että putkisto on puhdas. Jos havaitset epäpuhtauksia, pese putket huolellisesti.

  **Jos hydraulikkapiiri on tyypiltään suljettu ja paineenalainen, säädettävä varoventtiili on asennettu: 6 bar.**

 Veden tulo- ja poistoputkistoihin on aina suositeltavaa asentaa verkkosihdit.

 Jos hydraulikkaputkiston kierto estyy automaattiventtiilien toiminnan vuoksi, suojaa pumpun paineiskujen suojausjärjestelmillä..

 Mikäli piiri tyhjenetään pitkäksi aikaa, on suositeltavaa lisätä voitelunestettä pumpun juoksupyörään, jotta vältetään sen juuttuminen kun laite taas käynnistetään. Mikäli juoksupyörä juuttuu, vapauta se käsin.

Poista pumpun takakansi ja käännä muovipuhallinta varovasti. Jos akseli on vieläkin jumissa, irrota puhallin ja siirrä itse akselia. Kun juoksupyörä on vapaa, sijoita puhallin ja kansi takaisin paikoilleen.

Perustarkistukset

1. Tarkista, että mahdolliset hydraulikkapiirin sulkuventtiilit ovat auki.
2. Jos hydraulikkapiiri on tyypiltään suljettu, tarkista että laitteeseen on asennettu kapasiteetiltaan riittävä paisuntasäiliö.

Liitännät

1. Kytke vedenjäähdytin tulo- ja poistoputkiin yksikön takaosassa olevien liittimien avulla. Liitännässä on suositeltavaa käyttää joustavia letkuja.
2. Täytä hydraulikkapiiri jäähdyttimen takaosassa () olevan täyttöliittimen kautta.
3. Säiliössä on ilmanpoistovennttiili, joka tulee aktivoida manuaalisesti täytön yhteydessä. Jos hydraulikkaputkistossa on venttiilin yläpuolella kulkevia osuuksia, asenna näihin kohtiin ilmanpoistovennttiili.
4. Syöttö- ja poistoputkeen on suositeltavaa asentaa sulkuventtiili, jotta laitteen voi kytkeä irti kierrosta huoltotöiden ajaksi.
5. Jos jäähdytin toimii allas auki, pumppu täytyy asentaa altaan imuun sekä jäähdyttimen lähtöön.



Varoitus (mallit 022-120): kone on varustettu säiliön automaattisella suojalaitteella.

Jos veden sisääntuloaukko on tahattomasti suljettu pumpun käydessä ja veden poistoaukko on auki, ilmaa tulee säiliöön mahdollisen pinta-anturin väliintulon avulla. Ilma on poistettava hydraulipiiristä.

Lisätarkistukset

1. Tarkista, että säiliö ja putkisto on kokonaan täytetty vedellä ja ilma on poistettu asianmukaisesti.
2. Hydraulikkapiirin täytyy aina olla täynnä. Sen vuoksi täyttömäärä on tarkistettava säännöllisin väliajoin, tai laitteeseen voi asentaa automaattisen täyttöjärjestelmän.

Veden ominaisuudet

Asenna verkkosuodatin lauhdeveden tuloputkeen, jos laitteeseen ei ole asennettu valmiiksi suodatinta.



Veden ominaisuudet:

Lämpötila	≥50°F (10°C)	CL ⁻	<50 ppm
ΔT IN/OUT	5-15°C	CaCO ₃	70-150 ppm
Max glykoliprosentti	50	O ₂	<0.1 ppm
Paine	43.5-145 PSIG (3-10 barg)	Fe	<0.2 ppm
PH	7.5-9	NO ₃	<2 ppm
Sähkön johtavuus	10-500 μS/cm	HCO ₃ ⁻	70-300 ppm
Langelierin kyllästysindeksi	0-1	H ₂ S	<0.05 ppm
SO ₄ ²⁻	<50 ppm	CO ₂	<5 ppm
NH ₃	<1 ppm	Al	<0.2 ppm

Jäähdytettävien tarkoitettujen vakiomateriaalit voivat olla sopimattomia tietyille jäähdytysvesityypeille (ioniton, mineraaliton, tislattu). Tässä tapauksessa pyydämme ottamaan yhteyttä valmistajaan.

3.3.2 Vesi ja etyleeniglykoli

Jos laite on asennettu ulkotilaan tai ulkotilassa olevaan, ilman lämmitystä olevaan katokseen, putkistoissa oleva vesi voi jäätyä kylmien vuodenaikojen aikana silloin kun laite ei ole käynnissä.

Tämän vaaran vähentämiseksi:

- asenna jäähdyttimeen riittävät jäätymisenestosuojaukset, joita on saatavilla lisävarusteina;
- tyhjennä laite poistovennttiilin kautta, jos laite pysäytetään pitkäksi ajaksi;
- lisää kiertoveteen riittävä määrä jäänestoinetta (katso taulukko).

Poistuvan veden lämpötila [°C]	Etyleeniglykoli (tilavuus-%)	Ympäristön lämpötila
4	5	-2
2	10	-5
0	15	-7
-2	20	-10
-4	25	-12
-6	30	-15
-10	40	-20

3.3.3 Paisuntasäiliö

Laitteen tai putkiston vaurioitumisen välttämiseksi nesteen lämpötilan vaihtelun aiheuttaman nestemäärän lisääntymisen tai vähenemisen vuoksi laitteistoon on suositeltavaa asentaa riittävän suuri paisuntasäiliö.

Paisuntasäiliö asennetaan pumpun imuun säiliön takana olevaan liittimeen.

Suljetussa piirissä käytettävän paisuntasäiliön minimi-tilavuus lasketaan seuraavalla kaavalla:

$$V=2 \times V_{tot} \times (P_{t \min} - P_{t \max})$$

, jossa

V_{tot}= piirin kokonaistilavuus (litraa)

P_{t min/max}= ominaispaino veden minimi-/maksimilämpötilassa [kg/dm³].

Ominaispainot lämpötilan ja glykoliprosentin funktiona on esitetty allaolevassa taulukossa

% glykoli	Lämpötila [°C]						
	-10	0	10	20	30	40	50
0%	1.0024	1.0008	0.9988	0.9964	0.9936	0.9905	0.9869
10%	1.0177	1.0155	1.0130	1.0101	1.0067	1.0030	0.9989
20%	1.0330	1.0303	1.0272	1.0237	1.0199	1.0156	1.0110
30%	1.0483	1.0450	1.0414	1.0374	1.0330	1.0282	1.0230
40%	1.0636	1.0594	1.0525	1.0511	1.0461	1.0408	1.0350



Huomio: Täyttövaiheessa katso myös paisuntasäiliön täyttötietoja.

Jos ulkoilman lämpötila jäähdyttimessä on alle -10°C, paisuntasäiliö on siirrettävä suojattuun ympäristöön jäähdyttimen veden paluupuolen lähelle. Varoventtiilin ja ilmausventtiilin on jäätävä jäähdyttimeen.

3.4 Sähkövirtapiiri

3.4.1 Tarkistukset ja liitännät



Varmista, että virta ei ole kytkettynä ennen kuin kosket sähkökomponentteihin. Kaikkien sähköliitännöiden tulee vastata asennuspaikan vaatimia paikallisia määräyksiä.

Perustarkistukset

- Verkon jännitteen ja taajuuden tulee vastata jäähdyttimen arvokilvessä mainittuja arvoja. Syöttöjännite ei saa olla sähkökaaviossa esitettyjen toleranssialueiden ulkopuolella edes lyhyitä aikoja. Ellei toisin ole mainittu, toleranssialueet ovat: jännite +/- 10%, taajuus +/- 1%.
- Jännitteen tulee olla symmetrinen (jännitteiden tehollisten arvojen ja vaihekulmien peräkkäisissä vaiheissa keskenään samanlaisia). Suurin sallittu epätasapaino jännitteiden välillä: 2%.

Liitännät

- Jäähdyttimet kytketään sähkönsyöttöön 4-johtoisella kaapelilla, 3 napaa + maa, ilman nollajohdinta. Kaapelin minimihalkaisija, katso Kappale 7.
- Vedä kaapeli laitteen takapaneelissa olevan kaapelinpuristimen kautta ja liitä vaihejohdin ja nollajohdin päävirtakytkimen (QS) liittimiin ja maajohdin maadoitusliittimeen (PE).
- Varmista, että syöttökaapeli on varustettu suojuuksella suoria kontakteja vastaan, vähintään IP2Xo IPXXB.
- Asenna jäähdyttimen sähkönsyöttölinjaan sähkökaavion mukainen (RCCB - IDn = 0.3A): n sulakkeella varustettu automaattikytkin, jonka irtikytkentäteho on riittävä laitteen asennuspaikalla esiintyvään oikosulkuvirtaan nähden. Magnetoterminen kytkimen tulon nimellisjännite (In) on oltava sama kuin FLA ja D-tyypin toimenpidikäyrä.
- Verkkoimpedanssin maksimiarvo = 0,274 ohmia.

Lisätarkistukset

Varmista, että laite ja lisävarusteet on maadoitettu ja suojattu oikosulkua ja/tai ylikuormitusta vastaan.



Kun yksikkö on liitetty sähkövirtaan ja päävirtakytkin on suljettu (laite on kytketty jännitteeseen), sähkövirtapiiriin jännitteen arvot ovat vaarallisen korkeita. Ole erittäin varovainen!!



Asentaja on vastuussa pakollisten vähimmäistestien suorittamisesta, joilla varmistetaan asianmukainen sähköasennus paikallisten määräysten mukaisesti ja rinnastetusti asiaanliittyvän maadoitusjärjestelmän kanssa, mukaan lukien eristettyjä nollajohdinjärjestelmiä (IT) koskevat erityisvaatimukset.

3.4.2 Yleishälytys

Kaikki jäähdytinmallit on varustettu hälytystoiminnolla (katso sähkökaavio), joka koostuu riviliittimeen palaavasta vapaavaihtokontaktista: hälytys voi olla tyyppiltään ulkoinen keskitetty, äänimerkki, merkkivalo tai logiikkaan, esim. PLC:hen kytketty.

3.4.3 Etäkäynnistys/-pysäytys

Kaikkiin jäähdytinmalleihin voi asentaa etäohjauksella toimivan käynnistyksen ja pysäytyksen (Kappale 7).

- För att aktivera fjärrkontrollen rif. n.16387

- Som referensvariabel ON/OFF rif.n.8996

Obs: aktivera inte "Sup" och "Re" tillsammans.

Etäkäynnistys-/pysäytyskontaktin kytkentä, katso sähkökaavio (Kappale.7.)

3.5 Vedellä toimiva kuivainmalli(W)

Vesilauhdutuksella varustetut jäähdyttimet vaativat hydraulisen piirin, joka tuo lauhduttimeen kylmää vettä.

Vesijäähdytinmallissa on paineventtiili lauhdyttimen sisäänmenossa, jonka tehtävänä on säätää veden määrää siten, että lauhdutus on aina optimaalinen.

Ennakkotarkistukset

Jos lauhdyttimen vedensyöttö tapahtuu suljetusta piiristä, suorita kaikkihydraulisen pääpiirinkohdalla luetellut ennakkotarkistukset (kappale 3.3.1)

Liitäntä

- Onsuositeltavaa asentaa lauhdutuksen vesipiiriin erotusventtiili, jotta kone voidaan sulkea pois huollon ajaksi.
- Liitä veden lähtö- ja paluuputket yksikön takana sijaitseviin liittimiin.
- Jos lauhdutusvesi on kertakäyttöistä, on suositeltavaa asentaa piiriin suodatin lauhdyttimen sisääntulossa, jotta vältetään pintojen likaantumisaara.
- Jos piiri on suljettu, tarkista että se on täynnä vettä ja että ilmaus on suoritettu oikein.

4 Ohjaus

4.1 Ohjauspaneeli



Nuoli ylös -painike: suurentaa valitun muokattavan parametrin arvoa.



Nuoli alas -painike: pienentää valitun muokattavan parametrin arvoa.



ESC-painike: poistuu tallentamatta, palauttaa edelliselle tasolle, **PAINETTAESSA 5 s HÄLYTYKSEN KUITTAUS.**



SET-painike: poistuu ja tallentaa/vahvistaa arvon, siirtää seuraavalle tasolle, avaa asetusvalikon, **PAINETTAESSA 5 s JÄÄHDYTTIMEN KÄYNNISTYS.**

4.2 Symboleiden merkitys

Symboli	Symbolin tila	tehtävä	Symboli	Symbolin tila	tehtävä	
	Palaa	Kompressorin käy		Palaa	Lämpötilan arvo	
	Vilkkuu	Kompressorin valmiustila		Palaa	Painearvo	
	Ei pala	Kompressorin seis			Palaa	Painearvo
	Palaa	Hälytys		Palaa	Painearvo	
	Vilkkuu	Varoitus tai Hälytys kuitattavissa			Palaa	Painearvo
	Ei pala	Ei hälytystä			Palaa	Painearvo
	Palaa	Pumppu 1 käy		Palaa	Sulatuslämmitin päällä	
	Ei pala	Pumppu 1 seis		Ei pala	Sulatuslämmitin pois päältä	
	Palaa	Pumppu 2 käy (ei sisälty)		Palaa	Sulatuslämmitin päällä	
	Ei pala	Pumppu 2 seis (ei kuulu kokoonpanoon)		Ei pala	Sulatuslämmitin pois päältä	
	Palaa	Pumppu 2 käy (ei sisälty)		Palaa	Sulatuslämmitin päällä	
	Ei pala	Pumppu 2 seis (ei kuulu kokoonpanoon)		Ei pala	Sulatuslämmitin pois päältä	

4.3 Jäähdyttimen käynnistäminen

1. Kytke virta koneeseen kääntämällä päävirtakytkin QS asentoon ON.
2. Käynnistä kone painamalla painiketta "set".
3. Säädä haluttu lämpötila ohjaimen. (kappale 4.5.1)

Vaiheen tarkistus

Jos näyttöön käynnistämisen aikana tulee hälytys "Err3", käyttäjän täytyy tarkistaa, että erotuskytkimen sisääntulon liittimien johdot on asennettu oikein.

4.3.1 Käyttöön otossa tehtävät säädöt

1. Lämpötilan asettaminen, ovat kohdassa 4.5.
2. Pumpun säätäminen
Tarkista pumpun asianmukainen toiminta painemittarin avulla (lukemat P1 ja P0) ja tarkistamalla pumpun tietokilpeen merkityt paineen raja-arvot (Pmax ja Pmin).
P1 = paine pumpun käydessä
P0 = paine pumpun seisossa
 $P_{min} < (P1 - P0) < P_{max}$
- Esimerkki 1.
Olosuhteet:
suljettu piiri, paine P0 = 2 bar
pumpun tietokilpeen merkityt arvot: Pmin 1 bar / Pmax 3 bar
säädä venttiilin ulostuloa siten, että paine on 3 bar < P1 < 5 bar
- Esimerkki 2.
Olosuhteet:
avoin piiri, paine P0 = 0 bar
pumpun tietokilpeen merkityt arvot: Pmin 1 bar / Pmax 3 bar
säädä venttiilin ulostuloa siten, että paine on 1 bar < P1 < 3 bar
3. Tarkista pumpun asianmukainen toiminta samalla tavalla normaaleissa toimintaolosuhteissa. Tarkista myös, että pumpun virranvoimakkuus on tietokilpeen merkittyjen rajojen sisällä.
4. Kytke jäähdytys pois päältä ja täytä hydraulikkapiiri SET-lämpötilassa.
5. Tarkista, että "käsittävän" veden lämpötila ei laske alle 5 °C ja että hydraulikkapiirin toimintaympäristön lämpötila ei laske alle 5 °C. Jos lämpötila on liian alhainen, lisää sopiva määrä glykolia noudattaen kohdassa 3.3.3 annettuja ohjeita.

HUOMIO! Sulje vedenpoistoventtiili (asennus asiakkaan vastuulla) ennen jäähdyttimen pumpun käynnistämistä.

Pidä tuloventtiili (asennus asiakkaan vastuulla) aina auki.

Kun käynnistät pumpun, avaa jäähdyttimen vedenpoistoventtiiliä hitaasti ja säädä virtausmäärä kohdan 4.3.1 ohjeiden mukaisesti.

4.3.2 Aloittaminen korkean lämpötilan vedellä

Jos veden lämpötila piirissä on korkea (esim. 30–35 °C), sulje jäähdyttimen ulostulossa olevaa sulkuventtiiliä (asiakkaan asentama) vähitellen (mutta ei kokonaan, noin kaksi kolmasosaa!) vähentääksesi veden virtausta yksikön läpi. Avaa venttiili vähitellen heti, kun veden lämpötila laskee käyttölämpötilan alapuolelle.

Tärkeää: tässä tilanteessa voi esiintyä useita korkeapainehälytyksiä, jotka on kuitattava manuaalisesti.

Tärkeää: Tämän säädön avulla voidaan myös välttää putkissa esiintyvät vesivasarat, jotka johtuvat piirissä olevista ilmataskuista (ilmatasku on poistettava ilmausventtiileillä hydraulipiirin korkeimmissa kohdissa asiakkaan asentama).

4.4 Jäähdyttimen pysäyttäminen

Kun jäähdyttimen toimintaa ei enää tarvita, painamalla painiketta " **set** " (5 sek).
Älä kytke pääkytkintä QS pois päältä, jotta mahdolliset jäätymissuojalaitteet saavat edelleen virtaa.

4.5 Parametrien asetukset

Yleistä

Parametrien suojaustasoja on kaksi:

- Suorat User-(U): suoraan käytettävissä, **käyttäjä voi muuttaa**
- Salasanalla suojatut Service-(S): tarvitaan salasana, **(ei saa muuttaa)**.

4.5.1 Jäähdyttimen parametrit (CF9)

PARAMETRI	KOODI	TYYPPI	OLETUS-ARVO
Mittayksikkö	R1	U	OFF
Hälytysreleen hallinta	CFJ1	U	0
Oletusarvojen palautus	dEF	U	OFF
Etäkäynnistys/-pysäytys käyttöön	R7	U	0
Ohjelmistoversio	UEr	U	1.7.0
Yksikön osoite	CF30	U	1
Baudinopeus	CF31	U	5
Modbus-protokolla	CF32	U	1
Valvonta päälle/pois	SUP	U	OFF
Dynaaminen asetusarvo	Erd	U	OFF

4.5.2 Lämpötilan säätö (CNP)

PARAMETRI	KOODI	TYYPPI	OLETUS-ARVO
Lämpötilan säädön asetusarvo (vakio)	SEt	U	13.0
Lämpötilan säädön asetusarvo (tarkkuussäädön kokoonpanossa)	SEt	U	20.0
Lämpötilan säädön eroarvo (EI tarkkuussäädön kokoonpanossa)	dIF1	U	4.0

4.5.3 Huollon parametrit (PHt)

PARAMETRI	KOODI	TYYPPI	OLETUS-ARVO
Yksikön käyntitunnit	UH	U	
Yksikön käyntitunnit (X1000)	UHL	U	
Yksikön osittaiset käyntitunnit	UPH	U	
Yksikön osittaiset käyntitunnit (X1000)	UPHL	U	

PARAMETRI	KOODI	TYYPPI	OLETUS-ARVO
Kompressorin käyntitunnit 1	CIH	U	
Kompressorin käyntitunnit 1 (x1000)	CIHL	U	

4.5.4 Anturin parametrit (bt 1, bt2)

Anturi (bt 1)

PARAMETRI	KOODI	TYYPPI	OLETUS-ARVO
Korkean lämpötilan hälytys (vesi)	HR1	U	50

Anturi (bt2)

PARAMETRI	KOODI	TYYPPI	OLETUS-ARVO
Korkean lämpötilan hälytys (vesi)	HR2	U	50







4.5.5 Hälytyshistoria (ALH 1)

PARAMETRI	KOODI	TYYPPI	OLETUS-ARVO
Hälytyksen numero	HYS1	U	
Katso hälytyskoodi	HYS1	U	
Katso hälytyksen päivä ja kuukausi	HYS1	U	
Katso hälytyksen kellonaika (tunnit ja minuutit)	HYS1	U	
lämpötila bt1 hälytyksen esiintyessä	HYS1	U	
lämpötila bt2 hälytyksen esiintyessä	HYS2	U	
asetusarvot (SET) hälytyksen esiintyessä	HYS3	U	









4.6 Parametrien muuttaminen (User)

4.6.1 Jäähdyttimen parametrit (CF9)

Mittayksikkö

Kytke jäähdytyn päälle ON päävirtakytkimellä QS ja odota, kunnes näytössä näkyy OFF. Siirry parametrityyppiin U painamalla samanaikaisesti painikkeita esc ja set .	
Näkyviin tulee parametri "PAR". Siirry painikkeella set .	
Näkyviin tulee parametri "CF9". Siirry painikkeella set .	
Näkyviin tulee parametri "A1". Siirry painikkeella set .	
Oletusarvo on "OFF" = °C Valitse mittayksikkö painikkeilla ⇩ ja ⇧ . OFF : lämpötila = °C, Celsius ; paine = Bar; ON : lämpötila = °F, Fahrenheit; paine = PSI	
Vahvista painikkeella set .	
Palaat automaattisesti parametriin "A1" Parametri on nyt tallennettu. Poistu painamalla kolme kertaa painiketta esc .	

Hälytysten hallinta

Kytke jäähdytyn päälle ON päävirtakytkimellä QS ja odota, kunnes näytössä näkyy OFF. Siirry parametrityyppiin U painamalla samanaikaisesti painikkeita esc ja set .	
Näkyviin tulee parametri "PAR". Siirry painikkeella set .	
Näkyviin tulee parametri "CF9". Siirry painikkeella set .	
Näkyviin tulee parametri "A1". Valitse parametri "CFJ1" painikkeilla ⇩ ja ⇧ .	
Siirry painikkeella set .	
Oletusarvo on "0". Valitse hälytysreleen hallinta painikkeilla ⇩ ja ⇧ (kohta 4.5.1 taulukko 1)	
Vahvista painikkeella set .	
Palaat automaattisesti parametriin "CFJ1". Parametri on nyt tallennettu. Poistu painamalla kolme kertaa painiketta esc .	

Taulukko 1. Hälytysreleen hallinta (CFJ1.)

0	Rele normaalisti jännitteetön, saa jännitteen hälytyksestä.
1	Rele normaalisti jännitteinen (myös ohjauksen ollessa pois päältä), jännite poistuu hälytyksestä.
2	Rele normaalisti jännitteinen (vain ohjauksen ollessa päällä), jännite poistuu hälytyksestä tai kytkettäessä ohjaus pois päältä.

Oletusparametrit

Kytke jäädytyn päälle ON päävirtakytkimellä QS ja odota, kunnes näytössä näkyy OFF. Siirry parametrityyppiin U painamalla samanaikaisesti painikkeita esc ja set .	
Näkyviin tulee parametri "PAR". Siirry painikkeella set .	
Näkyviin tulee parametri "CF9". Siirry painikkeella set .	
Näkyviin tulee parametri "A1". Valitse parametri "dEF" painikkeilla ja .	
Siirry painikkeella set .	
Oletusarvo on "OFF". Vaihda arvo valinnasta "OFF" valintaan "On" painikkeilla ja .	
Vahvista painikkeella set .	
Muutaman sekunnin kuluttua palaat tilaan "OFF". Parametrit on palautettu automaattisesti. Poistu painamalla kolme kertaa painiketta esc .	







Etäohjaus ON/OFF

Kytke jäädytyn päälle ON päävirtakytkimellä QS ja odota, kunnes näytössä näkyy OFF. Siirry parametrityyppiin U painamalla samanaikaisesti painikkeita esc ja set .	
Näkyviin tulee parametri "PAR". Siirry painikkeella set .	
Näkyviin tulee parametri "CF9". Siirry painikkeella set .	
Näkyviin tulee parametri "A1". Valitse parametri "A7" painikkeilla ja .	
Siirry painikkeella set .	
Oletusarvo on "0". Valitse tila painikkeilla ja : (kohta 4.5.1 – Taulukko 2)	
Vahvista painikkeella set .	
Palaat automaattisesti kohtaan "A7". Parametri on nyt tallennettu. Poistu painamalla kolme kertaa painiketta esc .	

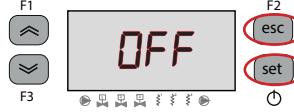
Taulukko 2. Etäkäynnistys/-pysäytys (A7)

0	Etäkäynnistys/-pysäytys pois käytöstä
1	Etäkäynnistys/-pysäytys käytössä yhdessä paikalliskäynnistysen/-pysäytyksen kanssa. Sähkökatkon sattuessa tai jos pääkytkin käännetään pois päältä, jäädytyn on käynnistettävä uudelleen paikalliskytkimellä virran kytkeytyessä uudelleen.
2	Vain etäkäynnistys/-pysäytys, paikallinen käynnistys/pysäytys pois käytöstä













Ohjelmistoversio (vain lukuoikeus)

<p>Kytke jäädytin päälle ON päävirtakytkimellä QS ja odota, kunnes näytössä näkyy OFF. Siirry parametrityyppiin U painamalla samanaikaisesti painikkeita esc ja set.</p>	
<p>Näkyviin tulee parametri "PAR". Siirry painikkeella set.</p>	
<p>Näkyviin tulee parametri "CF9". Siirry painikkeella set.</p>	
<p>Näkyviin tulee parametri "A1". Valitse parametri "UER" painikkeilla ⇩ ja ⇧.</p>	
<p>Siirry painikkeella set.</p>	
<p>Ohjelmistoversio tulee näkyviin.</p>	
<p>Poistu painamalla kolme kertaa painiketta esc.</p>	











Valvonnan käyttöönotto

<p>Kytke jäädytin päälle ON päävirtakytkimellä QS ja odota, kunnes näytössä näkyy OFF. Siirry parametrityyppiin U painamalla samanaikaisesti painikkeita esc ja set.</p>	
<p>Näkyviin tulee parametri "PAR". Siirry painikkeella set.</p>	
<p>Näkyviin tulee parametri "CF9". Siirry painikkeella set.</p>	
<p>Näkyviin tulee parametri "A1". Valitse parametri "SUP" painikkeilla ⇩ ja ⇧.</p>	
<p>Siirry painikkeella set.</p>	
<p>Oletusarvo on "OFF". Muuta arvoa painikkeilla ⇩ ja ⇧.</p>	
<p>Vahvista painikkeella set.</p>	
<p>Parametri on nyt tallennettu. Poistu painamalla kolme kertaa painiketta esc.</p>	

Modbus (osoite)

Kytke jäädytyn päälle ON päävirtakytkimellä QS ja odota, kunnes näytössä näkyy OFF. Siirry parametrityyppiin U painamalla samanaikaisesti painikkeita esc ja set .	
Näkyviin tulee parametri "PAR". Siirry painikkeella set .	
Näkyviin tulee parametri "CF9". Siirry painikkeella set .	
Näkyviin tulee parametri "A I". Valitse parametri "CF30" painikkeilla  ja  .	
Siirry painikkeella set .	
Oletusarvo on "1". Vaihda osoite painikkeilla  ja  .	
Vahvista painikkeella set .	
Parametri on nyt tallennettu. Poistu painamalla kolme kertaa painiketta esc .	

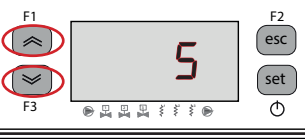









Modbus (bardinopeus)

Kytke jäädytyn päälle ON päävirtakytkimellä QS ja odota, kunnes näytössä näkyy OFF. Siirry parametrityyppiin U painamalla samanaikaisesti painikkeita esc ja set .	
Näkyviin tulee parametri "PAR". Siirry painikkeella set .	
Näkyviin tulee parametri "CF9". Siirry painikkeella set .	
Näkyviin tulee parametri "A I". Valitse parametri "CF3 I" painikkeilla  ja  .	
Siirry painikkeella set .	
Oletusarvo on "5". Vaihda protokolla painikkeilla  ja  .	
Vahvista painikkeella set .	
Parametri on nyt tallennettu. Poistu painamalla kolme kertaa painiketta esc .	

Taulukko 3. Bardinopeus (lisävaruste)(CF3 I)

1	2400	3	9600	5	38400	7	115200
2	4800	4	19200	6	57600		

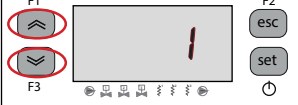
Modbus (protokolla)











Kytke jäädytyn päälle ON päävirtakytkimellä QS ja odota, kunnes näytössä näkyy OFF. Siirry parametryyppiin U painamalla samanaikaisesti painikkeita esc ja set .	
Näkyviin tulee parametri "PAR". Siirry painikkeella set .	
Näkyviin tulee parametri "CF9". Siirry painikkeella set .	
Näkyviin tulee parametri "A1". Valitse parametri "CF32" painikkeilla  ja  .	
Siirry painikkeella set .	
Oletusarvo on "1". Vaihda baudinopeus painikkeilla  ja  .	
Vahvista painikkeella set .	
Parametri on nyt tallennettu. Poistu painamalla kolme kertaa painiketta esc .	

Taulukko 4. Modbus-protokolla (lisävaruste)(CF32)

1	Parillinen	2	Ei mitään	3	Pariton
---	------------	---	-----------	---	---------

 **Huom.** Jos muutat MODBUS-parametreja, uudet parametrit on vahvistettava kytkemällä jäädytyn pois päältä ja takaisin päälle.

ERD-parametrin käyttöönotto

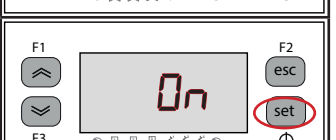
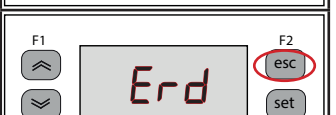
Kytke jäädytyn päälle ON päävirtakytkimellä QS ja odota, kunnes näytössä näkyy OFF. Siirry parametryyppiin U painamalla samanaikaisesti painikkeita esc ja set .	
Näkyviin tulee parametri "PAR". Siirry painikkeella set .	
Näkyviin tulee parametri "CF9". Siirry painikkeella set .	
Näkyviin tulee parametri "A1". Valitse parametri "Er-d" painikkeilla  ja  .	
Siirry painikkeella set .	
Oletusarvo on "OFF". Muuta arvoa painikkeilla  ja  .	
Vahvista painikkeella set .	
Parametri on nyt tallennettu. Poistu painamalla kolme kertaa painiketta esc .	

 **ERD-parametrin käyttöönotossa:** Veden asetustiläpötilä muuttuu ympäristön lämpötilan mukaisesti. Toiminto on käytössä vain, jos lämpötilan tarkkuussäätö on pois käytöstä (CPT=OFF).





4.6.2 Lämpötilan säätö (CNP)

Lämpötilan säädön asetus

Kytke jäädytyn päälle ON päävirtakytkimellä QS ja odota, kunnes näytössä näkyy OFF. Siirry parametrityyppiin U painamalla samanaikaisesti painikkeita esc ja set .	
Näkyviin tulee parametri "PAR". Siirry painikkeella set .	
Näkyviin tulee parametri "CF9". Valitse parametri "CNP" painikkeilla ⏏ ja ⏏ .	
Siirry painikkeella set .	
Näkyviin tulee parametri "SEt". Siirry painikkeella set .	
Oletusarvo on "13.0". Muuta arvoa painikkeilla ⏏ ja ⏏ .	
Vahvista painikkeella set .	
Parametri on nyt tallennettu. Poistu painamalla kolme kertaa painiketta esc .	

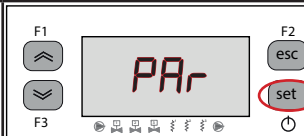
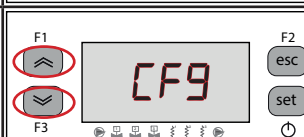
Tärkeää: Lämpötilan asettaminen välille 1–5 °C on sallittu vain asiantuntijoille tuotteen huolto-oppaan ohjeiden mukaisesti.

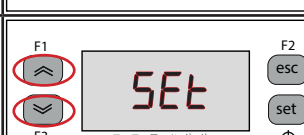
Lämpötilan eroarvon säätäminen

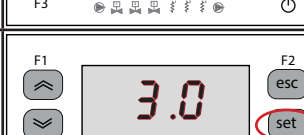
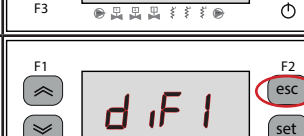
Kytke jäädytyn päälle ON päävirtakytkimellä QS ja odota, kunnes näytössä näkyy OFF. Siirry parametrityyppiin U painamalla samanaikaisesti painikkeita esc ja set .	
Näkyviin tulee parametri "PAR". Siirry painikkeella set .	
Näkyviin tulee parametri "CF9". Valitse parametri "CNP" painikkeilla ⏏ ja ⏏ .	
Siirry painikkeella set .	
Näkyviin tulee parametri "SEt". Valitse parametri "d i F I" painikkeilla ⏏ ja ⏏ .	
Siirry painikkeella set .	
Oletusarvo on "4.0". Muuta arvoa painikkeilla ⏏ ja ⏏ .	
Vahvista painikkeella set .	
Parametri on nyt tallennettu. Poistu painamalla kolme kertaa painiketta esc .	





4.6.3 Anturin parametri bt 1

Anturi bt 1

Kytke jäädytys päälle ON päävirtakytkimellä QS ja odota, kunnes näytössä näkyy OFF. Siirry parametrityyppiin U painamalla samanaikaisesti painikkeita esc ja set .	
Näkyviin tulee parametri "PAR". Siirry painikkeella set .	
Näkyviin tulee parametri "CF9". Valitse parametri "bt 1" painikkeilla ↓ ja ↑ .	
Siirry painikkeella set .	
Näkyviin tulee parametri "HA 1". Siirry painikkeella set .	
Oletusarvo on "60.0". Muuta arvoa painikkeilla ↓ ja ↑ .	
Vahvista painikkeella set .	
Parametri on nyt tallennettu. Poistu painamalla kolme kertaa painiketta esc .	

Toimenpide on sama anturille bt2.

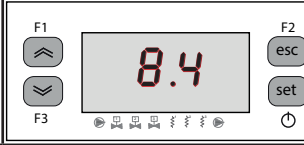
4.7 Näyttö anturi/ puhallin/ Kompressorin

Jäädytys toiminnassa. Painikkeella ↑ haetaan näkyviin anturit <i>bt 1, bt 2, bt 3, bP 1.....</i>	
Valitse anturi (esim. BT2) ja odota muutama sekunti.	
Anturin <i>bt 2</i> arvo tulee näkyviin.	
On suositeltavaa palata aina anturiin <i>bt 1</i> .	

Kuvaus:

bt 1 : poistuvan veden lämpötila-anturi

bt 2 : haihduttimen lämpötila-anturi

bt 3 : ympäristön lämpötila-anturi

bt 10 : sähköpaneelin lämpötila-anturi

bP 1 : piiri 1 lähetin

bP 2 : piiri 1 lähetin; (mallista ICEP080)

F_ _ _ : puhaltimen toiminta:

F_ _ _ : puhallin pois päältä

F_ - _ : puhallin 1 päällä, puhallin 2,3 pois päältä: (2 = mallista ICEP022) (3 = mallista ICEP080)

F- - _ : puhallin 1 ja 2 päällä, fan 3 pois päältä, (2 = mallista ICEP022) (3 = mallista ICEP080)

F- - - : puhallin 1,2 ja 3 päällä (mallista ICEP080)

[ICE] : kompressorien toiminta:

[_ _] : kompressorien disabled























[- _] : kompressorien pois päältä

[ICE-] : Kompressorin 1 ON, Kompressorin 2 pois päältä

[ICE] : kompressorien 1 ja 2 ON; (mallista ICEP055)

[ICE-] : with " i" flashing compressor ready to start, Kompressorin 2 pois päältä

4.8 Kellonajan/päivämäärän asettaminen

<p>Kytke jäädytín päälle ON päävirtakytkimellä QS ja odota, kunnes näyttössä näkyy OFF. Siirry päivämäärän/ajan valikkoon painamalla samanaikaisesti painikkeita  ja .</p>	
<p>Näkyviin tulee parametri "FrEE". Siirry painikkeella .</p>	
<p>Näkyviin tulee parametri "A1". Valitse parametri "CL" painikkeilla  ja .</p>	
<p>Siirry painikkeella .</p>	
<p>Näkyviin tulee parametri "HOUr". Paina viisi sekuntia painiketta . Parametri vilkkuu.</p>	
<p>Valitse muutettava päivä, kellonaika tai vuosi painikkeilla  ja .</p>	
<p>Siirry painikkeella .</p>	
<p>Muuta arvoa (esim. vuosi) painikkeilla  ja .</p>	
<p>Vahvista painikkeella .</p>	

Muuta toista arvoa (esim. päivä) painikkeilla  ja .



Poistu painikkeella .
Parametri lakkaa vilkkumasta.









Poistu painamalla samanaikaisesti painikkeita  ja .

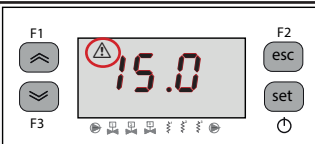

⚠ Kellon/päivämäärän muistin maksimikesto on kolme päivää. Jos ohjaimen ei kytketä virtaa yli kolmeen päivään, asetetut tunnit/kuukausi/vuosi häviävät. Aseta kello käynnistäessäsi koneen ja aina tarvittaessa.







4.9 Hälytysten hallinta

<p>Hälytystilanteessa näkyviin tulee hälytyskoodin ja hälytyksen symboli näkyvän näytön vasemmassa yläkulmassa.</p> <p>Palaa jatkuvasti = hälytys Vilkkuu = varoitus / hälytys kuitattavissa</p> 	
<p>Siirry painikkeella set.</p>	
<p>Näkyviin tulee parametri "ALH i". Valitse parametri "AL" painikkeella ↵.</p>	
<p>Siirry painikkeella set.</p>	
<p>Näkyviin tulee hälytyskoodi, esim. "Er04". Tarkista painikkeella ↵, onko muita hälytyksiä.</p>	
<p>Korjaa virhe ennen hälytyksen kuittaamista. Kun virhe on korjattu, hälytyksen symboli alkaa vilkkua. Nyt voit kuitata hälytyksen.</p>	
<p>Paina painiketta esc, kunnes hälytys häviää näkyvistä.</p>	

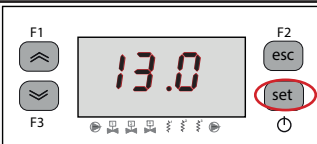
Hälytys- ja varoitusluettelo

Koodi	Kuvaus	Toimenpide	Kuittaus
Er01	Anturin bt1 kosketushäiriö tai vika	Hälytys	M
Er02	Anturin bt2 kosketushäiriö tai vika	Hälytys	M
Er03	Anturin bt3 kosketushäiriö tai vika	Hälytys	A
Er05	Anturin bt10 kosketushäiriö tai vika	Hälytys	A
Er06	Anturin bP1 kosketushäiriö tai vika	Hälytys	M
Er08	Korkeapainekeytkin piiri 1	Hälytys	M
Er09	Matalapainekeytkin piiri 1	Hälytys	M
Er12	Korkea lämpötila bt1	Hälytys	M
Er13	Alhainen lämpötila bt1	Hälytys	A
Er14	Korkea lämpötila bt2	Hälytys	M
Er15	Alhainen lämpötila bt2	Hälytys	M
Er16	Korkea lämpötila bt3	Hälytys	A
Er17	Alhainen lämpötila bt3	Hälytys	A
Er18	Kompressorin lämpösuojaus 1	Hälytys	M
Er20	Pumpun lämpösuojaus 1	Hälytys	M
Er22	Alhainen vedenpinnantas / differentiaalipainekeytkin	Hälytys	M
Er23	Vaihemonitori	Hälytys	M
Er24	Paisuntasäiliö vaurioitunut tai irronnut	Hälytys	M
Er25	Kompressorin 1 käyntiajan ylitys	Varoitus	M
Er27	Yksikön käyntiajan ylitys	Varoitus	M
Er28	Kellon muisti	Varoitus	A
Er29	Jäähdyttimen kokoonpano	Varoitus	A





4.10 Hälytyshistoria

Jäähdytin toiminnassa. Hae hälytyshistoria näkyviin painikkeella set .	
Siirry tietoihin painikkeella set .	
Näytä parametrit painikkeilla  ja  .	
Näytä arvo painikkeella set .	

5 Huolto

- Laite on suunniteltu ja tarkoitettu jatkuvatoimiseksi. Osien käyttöikä riippuu suoraan suoritetuista huolloista.
-  Huoltoa tai varaosia tilattaessa on mainittava laitteen tunnistetiedot (malli ja sarjanumero), jotka on merkitty laitteen ulkopuolelle kiinnitettyyn arvokilpeen. (www.polewr.com)

5.1 Yleisiä varoituksia

-  Tarkista aina ennen huoltotoita, että jäähdytin on irrotettu sähkövirrasta.
-  Käytä aina valmistajan alkuperäisiä varaosia, sillä muuten valmistajan takuu ei vastaa toimintahäiriöistä.
-  Jos jäähdytysnestettä vuotaa ulos, ota yhteys ammattitaitoiseen ja valtuutettuun henkilöstöön.
-  Schrader-venttiiliä saa käyttää vain laitteen toimintahäiriöiden yhteydessä. Muussa tapauksessa takuu ei vastaa jäähdytysaineen väärin suoritettua lisäyksen aiheuttamista vaurioista.

5.2 Jäähdytysaine













Jäähdytysaineen täyttö: takuu ei vastaa asiantuntemattoman henkilöstön suorittaman jäähdytysaineen lisäyksen mahdollisesti aiheuttamista vaurioista. 

-  Laite sisältää fluorattuja kasvihuonekaasuja. Jäähdytysneste R513A on normaalissa lämpötilassa ja paineessa väritön kaasu, joka kuuluu SAFETY GROUP A1 - EN378 (ryhmän 2 neste direktiivin PED 2014/68/EU) mukaisesti; GWP (Global Warming Potential) = 629.

-  Jos jäähdytysnestettä vuotaa ulos, tuuleta tila.

5.3 Ennakoiva huolto

Suorita seuraavat toimenpiteet varmistaaksesi jäädyttimen maksimaalisen tehon ja luotettavan toiminnan:

Huoltotoimenpiteenkuvaus	Huoltoväli (normaaleissa käyttöolosuhteissa)			
	Päivittäin	6 kk välein	12 kk välein	36 kk välein
<p>Toimenpide</p> <p>tarkistus  huolto </p>				
Tarkista, että POWER ON -merkkivalo palaa.				
Tarkista ohjauspaneelin merkkivalot.				
Puhdista kondensaattorin siivet.				
Tarkista sähköinen tehonotto.				
Tarkista jäädytysaineen vuodot.				
Tarkista ja puhdista Varoventtiili Vesi (jos on)*				
Kontrollera elsystemet och elpanelen**				
Tarkista lämpötila-anturit. Vaihda tarvittaessa.				 
Kuivaimen huoltovälinesarja.				



Saatavilla on seuraavat varaosasarjat (katso Kappaler 7.):

- a) huoltotarvikkeet: sähkösarja; kompressorin varaosasarja; puhaltimen varaosasarja; Haihdutin varaosasarja; Pumppu varaosasarja; Vandtank varaosasarja;
b) erillisiä varaosia.

*Täyden tehokkuuden varmistamiseksi on varoventtiilit tarkastettava säännöllisesti. Ajan myötä epäpuhtaudet voivat laskeutua lähelle pistoketta; tämän johdosta on istuin huuhdeltava säännöllisesti. Tällainen huuhtelu saadaan aikaan tyhjentämällä venttiili manuaalisesti kääntämällä nuppia nuolien osoittamaan suuntaan.

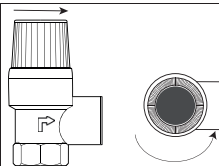

Tärkeää: Varmista tämän toimenpiteen jälkeen, että käyttöpaine tulee palautetuksi.



** Määräaikaishuollon yhteydessä on myös tarkistettava koneen sähköjärjestelmä ja sähköpaneeli paikallisen lainsäädännön mukaisesti. Lisäksi laitteisto ja sähköjohtimet on aina mahdollisuuksien mukaan tarkastettava silmämääräisesti, ja tehokomponenttien liittimien oikea kiristys on myös tarki-

stettava sähkökaaviossa ilmoitettujen kiristysmomenttien mukaisesti.

5.4 äteöljyn ja -nesteiden hävittäminen

Laitteen putkistoissa kiertävä jäädytysneste ja voiteluöljy on otettava talteen paikallisten ympäristömääräysten mukaisesti.

Jäädytysnesteen talteenotto suoritetaan ennen laitteiston lopullista romuttamista ((EU) n:o 517/2014 art. 8).

	KIERRÄTYS JÄTEHUOLTO 
Teräsrakenteet	Teräs/Epoksiharts, polyesteri
Vesisäiliö	Alumiini/Kupari/teräs
Putkistot/kokoomaputket	Kupari/Alumiini/Hiiliteräs
Putkistojen eristeet	Nitriilikumi (NBR)
Kompressori	Teräs/Kupari/Alumiini/öljy
Lauhdutin	Teräs/Kupari/Alumiini
Pumppu	Teräs/Valurauta/Pronssi
Puhaltimen	Alumiini
Jäädytysaine	R513A
Venttiilit	Pronssi/Kupari
Sähkökaapelit	Kupari/PVC

Sähkökomponentteja sisältävät laitteet on hävitettävä erikseen sähkö- ja elektroniikkajätteen mukana paikallisen ja voimassa olevan lainsäädännön mukaisesti.



6 Vianetsintä

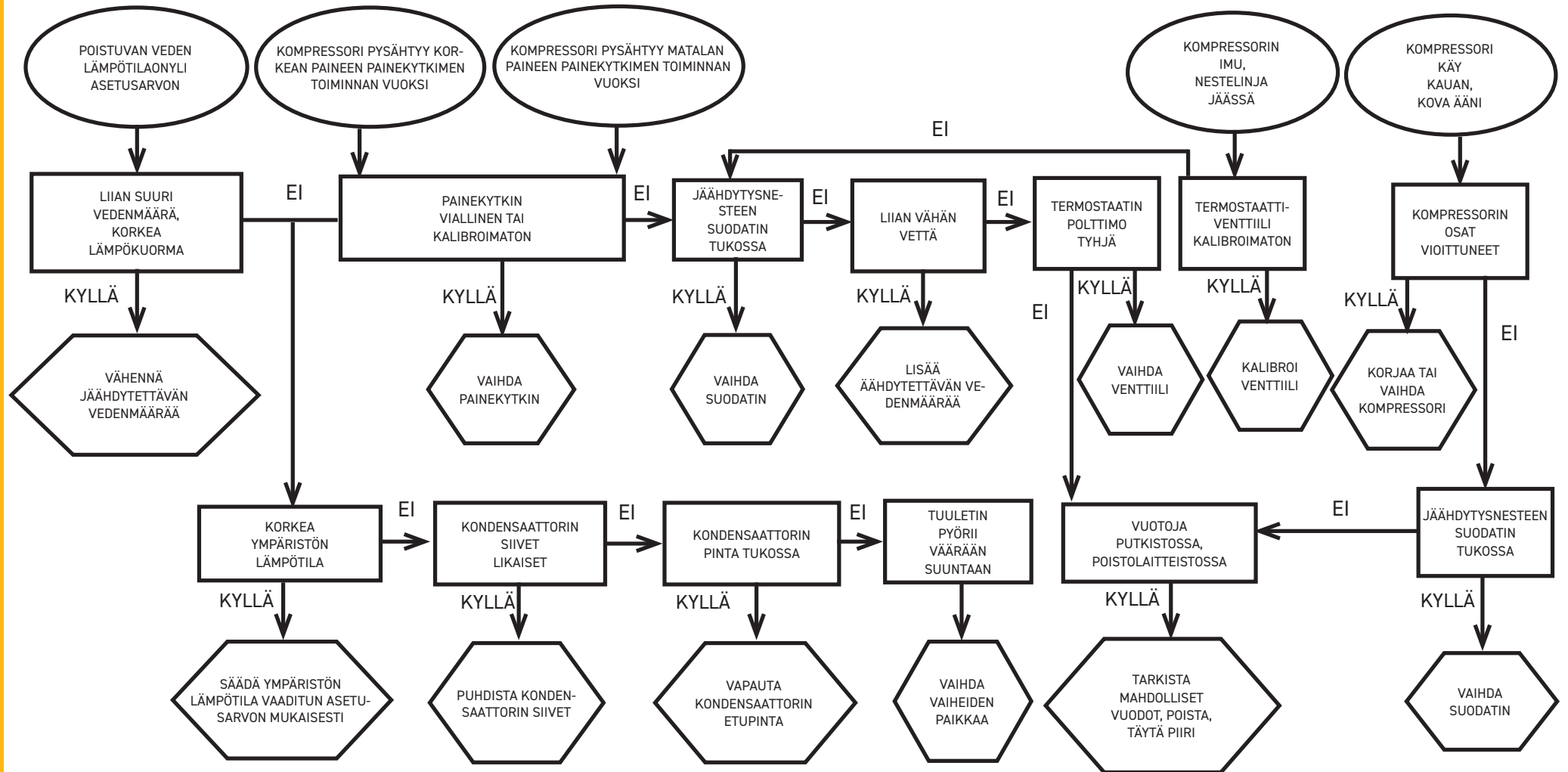
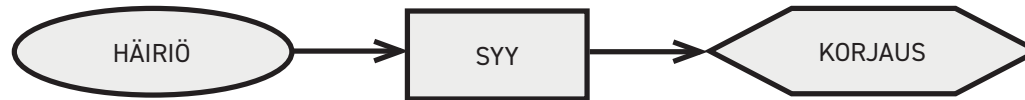

1 Sikkerhet	2
1.1 Bruksanvisningen er viktig.....	2
1.2 Advarselssignaler.....	2
1.3 Sikkerhetsinfo.....	2
1.4 Gjenværende risiko.....	2
2 Innledning	3
2.1 Transport.....	3
2.2 Flytting.....	3
2.3 Inspeksjon.....	3
2.4 Lagring.....	3
3 Installasjon	3
3.1 Arbeidsområde.....	3
3.2 Versjoner.....	3
3.3 Hydraulisk krets.....	3
3.3.1 Kontroller og tilkobling.....	3
3.3.2 Vann og etylenglykol.....	4
3.3.3 Ekspansjonstank.....	4
3.4 Elektrisk krets.....	5
3.4.1 Kontroller og tilkobling.....	5
3.4.2 Generell alarm.....	5
3.4.3 Fjernstyrt ON/OFF.....	5
3.5 Vannversjon (W).....	5
4 Kontroll	6
4.1 Kontrollpanel.....	6
4.2 Symbolenes betydning.....	6
4.3 Starte kjøleren.....	6
4.3.1 Justering ved oppstart.....	6
4.3.2 Starter med vann med høy temperatur.....	6
4.4 Stoppe kjøleren.....	7
4.5 Parameterinnstillinger.....	7
4.5.1 Kjølerparametere (CF9).....	7
4.5.2 Temperaturkontroll (CTP).....	7
4.5.3 Vedlikeholdsparametere (MHE).....	7
4.5.4 Probeparametere (bE 1, bE2).....	7
4.5.5 Alarmhistorikk (RLH 1).....	7
4.6 Endre parametere (User).....	8
4.6.1 Kjølerparametere «CF9».....	8
4.6.2 Temperaturkontroll «CTP».....	13
4.6.3 Probeparameter «bE 1».....	14
4.7 Visualisering av sensor/ vifte/ Kompressor.....	14
4.8 Stille inn klokkeslett/dato.....	15
4.9 Alarmstyring.....	16
4.10 Alarmlogg.....	17
5 Vedlikehold	17
5.1 Generelle advarsler.....	17
5.2 Kjølevæske.....	17
5.3 Forebyggende vedlikeholdsprogram.....	18
5.4 Avhending.....	18

7 Appendiks





7.1 Tegnforklaring
7.2 Installasjonsdiagram
7.3 Flytting - Arbeidsområde
7.4 Tekniske data
7.5 Mål
7.6 Reservedelsliste
7.7 Eksplosjonstegninger
7.8 Kretsskjema
7.9 Elektrisk diagram

1 Sikkerhet

1.1 Bruksanvisningen er viktig

- Ta vare på den i hele maskinens levetid.
- Les den før maskinens tas i bruk.
- Den er gjenstand for endringer: for oppdatert informasjon, se versjonen i maskinen.

1.2 Advarselssignaler

	Instruks for å unngå personskader.
	Instruks som må følges for å unngå skader på apparatet.
	En autorisert vedlikeholdstekniker må være tilstede.
	Symbolene som benyttes blir forklart i avsnitt 7.

1.3 Sikkerhetsinfo

 Hver maskin er utstyrt med elektrisk hovedbryter, slik at man kan foreta inngrep i full sikkerhet. Benytt alltid denne innretningen for å unngå risiko under vedlikehold.

 Bruksanvisningen henvender seg til sluttbrukeren kun når det gjelder operasjoner som kan utføres med lukkede skjermer: operasjoner installasjon/oppstart/Vedlikehold hvor det er behov for å åpne dem med verktøy, må utføres av faglært personell.

 Kun for installasjon på steder som ikke er tilgjengelige for allmennheten, enten på et sikret sted med begrenset tilgang eller på et nivå som ikke er under 2,5 m, eller i sikrede takområder, med mindre de har fått tilsyn eller instruksjoner om bruk av apparatet av en person som er ansvarlig for deres sikkerhet.



 Installasjonsavstanden fra veggen og ledig driftsplass er angitt i avsnitt 7.3.

 Merk: Overhold min./maks. temperatur og trykk angitt i avsnitt 7.4, og det totale driftstemperaturområdet angitt i avsnitt 7.2.

 Alle enhetene kunne installeres utendørs.

 Alle de elektriske koblingene må være i overensstemmelse med gjeldende forskrifter.

 Overstig ikke de grenseverdiene som er oppgitt på typeskiltet.

  Det er brukerens ansvar å unngå belastning som avviker fra det innvendige statiske trykket. Dersom det eksisterer jordskjelvfare, må enheten sikres på forskriftsmessig vis. Bruk maskinen kun til profesjonelt arbeid og til de arbeidsoppgaver den er laget for.

 Det er brukerens ansvar å kontrollere alle aspektene ved anlegget der produktet er installert, følge alle aktuelle sikkerhetsforskrifter for industrien og alle bruksbeskrivelsene for produktet som finnes i bruksanvisningen og i all annen dokumentasjon som følger med produktet. Tukling med eller utskifting av hvilken som helst del utført av uautorisert personell og/eller ukorrekt bruk av maskinen, fører til at garantien opphører. Produsenten fraskriver seg ethvert nåværende og fremtidig ansvar for skader på personer, gods eller på maskinen som skyldes upåpasselighet fra operatørens side, manglende overholdelse av alle instruksene i denne bruksanvisningen eller manglende hensyntagen til gjeldende sikkerhetsforskrifter når det gjelder anlegget. Produsenten påtar seg intet ansvar for eventuelle skader som skyldes tukling med og/eller endring på emballasjen. Det er brukerens ansvar å forsikre seg om at de spesifikasjoner som gis for valg av maskinen eller enhetene den består av og/eller tilleggsutstyr er tilstrekkelige for korrekt og forutsigbar bruk av maskinen eller komponentene dens.

 **ADVARSEL: Konstruktøren forbeholder seg retten til å endre informasjonene i denne manualen uten forvarsel.**

For komplett og oppdatert informasjon anbefales brukeren å konsultere manualen på enheten.

1.4 Gjenværende risiko

Installasjon, igangsetting, stansing og vedlikehold av maskinen skal alltid utføres i overensstemmelse med instruksene i den tekniske dokumentasjonen som følger med produktet og i alle tilfeller slik at det ikke oppstår noen risikabel situasjon.

Risikoene som det ikke har vært mulig å eliminere i prosjekteringsfasen, er vist i tabellen under.

angjeldende del	gjenværende risiko	sikker	fremgangsmåte
batteri varmeveksler	små kuttskader	berøring	unngå berøring, benytt arbeidshansker
ventilasjonsrist og vifte	skader	hvis det stikkes inn spisse gjenstander gjennom risten mens viften er igang	stikk aldri en gjenstand inn gjennom ventilasjonsristen og plasser aldri noen gjenstand på ristene
innvendig i enheten: kompressor og tilførselsrør	forbrenninger	kontakt	unngå berøring, benytt arbeidshansker
innvendig i enheten: metalleder og elektriske ledninger	forgiftning, støt, alvorlige forbrenninger	isolasjonsfeil på mateledningene på tilførselssiden av enhetens el-panel, metalleder under spenning	tilfredstillende elektrisk beskyttelse av mateledningen; stor nøyaktighet ved jording av metalledene

angjeldende del	gjenværende risiko	sikker	fremgangsmåte
utvendig på enheten: området rundt enheten	forgiftning, alvorlige forbrenninger	brann pga. av kortslutning eller overoppheting av mateledningen på tilførselsiden av el-panelet på enheten	snitt på lederne og beskyttelsessystem på den elektriske mateledningen i samsvar med gjeldende normer

2 Innledning

Motorene på kompressor, pumpe og vifte er utstyrt med termisk sikring som beskytter dem mot eventuell overoppheting.

2.1 Transport

Emballert enhet skal være:

- i oppreist posisjon;
- beskyttet mot vind og vær;
- ikke utsettes for støt.

2.2 Flytting

Bruk en gaffeltruck som er kraftig nok til vekten som skal løftes, og unngå enhver form for sammenstøt.

2.3 Inspeksjon

- På fabrikken blir alle enhetene satt sammen, kablet, ladet med kjølevæske og olje og utprøvet;
- når du mottar maskinen må du kontrollere at den er i god stand: reklamer umiddelbart til transport-selskapet dersom du finner noen skader;
- pakk ut enheten nærmest mulig installasjonsstedet.

2.4 Lagring

- Lagre den emballerte enheten på et rent sted, beskyttet mot fuktighet og atmosfæriske fenomener.
- sett ikke enhetene oppå hverandre;
- følg instruksene på emballasjen.

3 Installasjon

 For optimal installasjon må man følge instruksene i avsnitt.7.

 Det installerte produktet må være passende beskyttet mot brannfare (ref. EN378-3).

 **Det anbefales at alle kjølere utstyres med passende forfilter i nærheten av kjølerens vanninntak (grade av filtrering: min.05mm; max1.0mm).**

 **Væsker som avkjøles**

Væskene som skal avkjøles må være kompatible med materialene som benyttes.

Eksempler på væsker som brukes er vann eller blanding av **vann og etyl- eller propylenglykol**.

Væskene som skal avkjøles må ikke være antenkelige.

Dersom væskene som avkjøles inneholder farlige stoffer (som f. eks. etylen/propylen-glykol) må eventuell væske som lekker ut fra et lekkasjeområde samles opp, da den er skadelig for miljøet. Dersom det hydrauliske kretsløpet skal tømmes, må man følge gjeldende forskrifter og innholdet må ikke slippes ut i miljøet.

3.1 Arbeidsområde

 La det være et rom på 1,5 meter rundt enheten.

La det være minst 2 meter rom over vannkjøleren på modeller med vertikal utblåsning av kondensasjonsluften.

3.2 Versjoner

Luftversjon: Aksialvifter (A)

Unngå situasjoner med resirkulering av kjøleluften.

Ikke tildekk ventilasjonsåpningene.

På versjoner med aksiale vifter, bør ikke den brukte luften kanaliseres.

Vannversjon (W)

If the water to the condenser is in opencircuit, install a meshfilter on the condensation water inlet.

Please note that for special cooling water types such as demineralized, deionized or distilled it is necessary to contact the manufacturer to verify which kind of condenser should be used since the standard material may not be suitable.

3.3 Hydraulisk krets

3.3.1 Kontroller og tilkobling

 Før kjøleapparatet tilkobles og kretsen lades, må man forsikre seg om at rørene er rene. I motsatt tilfelle må de rengjøres nøye.

  **Hvis den hydrauliske kretsen er av lukket type, anbefales det på trykksiden en sikkerhetsventil innstilt på: 6 bar.**

 Det anbefales alltid å installere nettfiltre på vanntilførsels- og vannavløpsrøret.

 Dersom den hydrauliske kretsen er utstyrt med automatiske ventiler, må pumpen beskyttes med støtabsorberende systemer.

 Dersom kretsen tømmes i forbindelse med lengre stillstandsperioder, lønner det seg å helle et flytende smøremiddel på pumperotoren for å unngå blokkasje ved neste igangsetting. Hvis det oppstår blokkasje på rotoren, må den frigjøres manuelt.

Fjern det bakre dekselet på pumpen og drei forsiktig på plastviften. Hvis akselen fortsatt er blokkert, fjerner du viften og dreier direkte på akselen. Når rotoren er frigjort, settes viften og dekselet tilbake på plass.

Innledende kontroll

1. Kontroller at de eventuelle avlastingsventilene på den hydrauliske kretsen er åpne.
2. Hvis den hydrauliske kretsen er av den lukkede typen, må man kontrollere at det er installert en ekspansjonstank med tilfredsstillende kapasitet.

Tilkobling

1. Koble vannkjøleren til inntaks- og avløpsrørene ved hjelp av koblingene bak på apparatet. Det anbefales å benytte fleksible ledd, for å redusere stivheten på systemet.
2. Fyll hydraulikkretsen ved hjelp av ved tilkoblingspunktet bak på kjøleren () .
3. Tanken er utstyrt med en avlastingsventil som skal aktiveres manuelt i forbindelse med påfylling. I den forbindelsen må man, dersom hydraulikkretsen på noen steder er høyere, installere en avlastingsventil på disse stedene.
4. Det anbefales å utstyre tilførsels- og avløpsrørene med en kran, slik at man kan koble maskinen fra kretsen i forbindelse med vedlikehold.
5. Dersom chilleren fungerer med åpen tank, må pumpen installeres slik at væsken suges opp fra tanken og tilføres chilleren.

 **Advarsel (modell 022-120): maskinen er utstyrt med en automatisk beskyttelsesanordning for tanken.**

Hvis vanninntaket utilsiktet lukkes når pumpen går og vannuttaket er åpent, vil luft komme inn i tanken med sannsynlig inngrep fra nivåsensoren. Det vil være nødvendig å luften den hydrauliske kretsen for å eliminere luften.

Påfølgende kontroller

1. Kontroller at tanken og kretsen er helt full av vann og skikkelig utluftet.
2. Vannkretsen må alltid være full. I den forbindelse bør man kontrollere og etterfylle jevnlig, eller man kan utstyre anlegget med en anordning for automatisk påfylling

Spesifikasjoner for vann

Hvis det ikke allerede er installert, må du installere nettfiltre på vanninntaket.

  Spesifikasjoner for vann:

Temperatur	≥50°F (10°C)	CL ⁻	<50 ppm
ΔT IN/OUT	5-15°C	CaCO ₃	70-150 ppm
Max % glykol	50	O ₂	<0.1 ppm
Trykk	43.5-145 PSiG (3-10 barg)	Fe	<0.2 ppm
PH	7.5-9	NO ₃	<2 ppm
Elektrisk lederevne	10-500 μS/cm	HCO ₃ ⁻	70-300 ppm
Metningsindikasjon Langelier	0-1	H ₂ S	<0.05 ppm
SO ₄ ²⁻	<50 ppm	CO ₂	<5 ppm
NH ₃	<1 ppm	Al	<0.2 ppm

Ved bruk av bestemte kjølevann (deionisert, demineralisert, destillert) er det mulig at standardmaterialene beregnet på kjøleren.

3.3.2 Vann og etylenglykol

Dersom installasjonen skjer utendørs eller i lukkede lokaler som ikke er oppvarmet, kan det skje at vannet i kretsene fryser i forbindelse med at anlegget ikke brukes under den kalde årstid.

For å redusere denne faren:

- utstyre kjøleren med passende frostbeskyttelse, som leveres som ekstrautstyr av produsenten;
- tømme anlegget ved hjelp av dreneringsventilen i forbindelse med lengre stillstand;
- tilsette en passende mengde med frostvæske til sirkulasjonsvannet (se tabell).

Temperatur på avløpsvannet [°C]	Etylenglykol (% vol.)	Omgivelsestemperatur
4	5	-2
2	10	-5
0	15	-7
-2	20	-10
-4	25	-12
-6	30	-15
-10	40	-20

3.3.3 Ekspansjonstank

For å unngå at økning eller reduksjon av væskevolumet som følge av en større temperaturforandring kan skade maskinen eller kretsen, lønner det seg å installere en ekspansjonstank med tilstrekkelig kapasitet.

Ekspansjonstanken skal installeres på inntakssiden av pumpen, på koblingen bak på beholderen.

For å regne ut minimumsvolumet på ekspansjonstanken som skal tilkobles en lukket krets, kan man benytte følgende formel:

$$V = 2 \times V_{tot} \times (P_{t \min} - P_{t \max})$$

hvor

V_{tot} = vol. totalt i kretsen (i liter)

P_{t min/max} = spesifikk vekt ved minimal/maksimal temperatur vannet kan nå [kg/dm³].

Verdiene for spesifikk vekt på bakgrunn av temperaturen og glykolandelen er vist i tabellen under.

% glykol	Temperatur [°C]						
	-10	0	10	20	30	40	50
0%	1.0024	1.0008	0.9988	0.9964	0.9936	0.9905	0.9869
10%	1.0177	1.0155	1.0130	1.0101	1.0067	1.0030	0.9989
20%	1.0330	1.0303	1.0272	1.0237	1.0199	1.0156	1.0110
30%	1.0483	1.0450	1.0414	1.0374	1.0330	1.0282	1.0230
40%	1.0636	1.0594	1.0525	1.0511	1.0461	1.0408	1.0350

 **Viktig: Ved påfylling se også opplysningene for fylling av ekspansjonstanken.**

Hvis omgivelseslufttemperaturen ved kjøleren er mindre enn -10°C, må du flytte ekspansjonstanken til en beskyttet omgivelse nær vannretursiden av kjøleren. Sikkerhetsventilen og lufterventilen må forbli ved kjøleren.

3.4 Elektrisk krets

3.4.1 Kontroller og tilkobling



Før det foretas noen som helst operasjon på elektriske deler, må man forsikre seg om at det ikke er spenning.

Alle de elektriske koblingene må være i overensstemmelse med gjeldende forskrifter.

Innledende kontroller

- Nettspenning og frekvens må svare til verdiene som er vist på vannkjølerens typeskilt. Nettspenningen må selv ikke over kortere tidsrom være utenfor tolleransesegrensen som er vist på det elektriske skjemaet og som normalt skal være +/- 10% for spenningen og +/- 1% for frekvensen.
- Spenningen skal være symmetrisk (effektive spenningsverdier og fasevinkler blant påfølgende faser som er identiske med hverandre). Maksimalt tillatt ubalanse mellom spenningene er tilsvarende 2%.

Tilkobling

- Strømforsyningen til vannkjølerne skjer ved hjelp av en kabel med 4 ledere, 3 poler + jord. Angående nødvendig tverrsnitt på nettleddningen, se avsnittet 7.
- Før kablet gjennom kabelklemmen på det bakre panelet på maskinen og koble fase og nøytral til klemmene på hovedbryteren (QS), jordlederen skal kobles til jordklemmen (PE).
- Ved utgangspunktet til tilførselskablet skal det være en sikring mot direkte kontakt på minst IP2Xo IPXXB.
- På den elektriske tilførselslinjen til vannkjøleren installeres en automatisk differensialbryter på (RCCB - IDn = 0.3A), med den maksimumskapasiteten som er oppgitt på det elektriske referanseskjemaet og med en avbryterevne som er tilstrekkelig til den kortslutningsstrømmen som eksisterer på stedet der maskinen installeres. Den nominelle strømstyrken "In" på denne magnetotermiske bryteren må være tilsvarende FLA og aktiveringskurven av typen D.
- Nettets maks. impedensverdi = 0,274 ohm.

Påfølgende kontroller

Forsikre deg om at maskinen og tilhørende apparater er jordet og beskyttet mot kortslutning og/eller overlast.



Når enheten er tilkoblet og hovedbryteren på tilførselssiden er lukket (slik at maskinen er under spenning), vil spenningen i den elektriske kretsen nå farlige verdier. Utvis største forsiktighet!



Det er installatørens ansvar å utføre de obligatoriske minimumstestene for å sikre korrekt elektrisk installasjon i samsvar med lokale forskrifter og i samordning med det relevante jordingssystemet, inkludert spesifikke krav til isolerte nøytralsystemer (IT).

3.4.2 Generell alarm

Alle kjølerne er utstyrt med maskinalarm (se elektrisk skjema), som består av en fri utvekslingskontakt på klemmebrettet: dette gjør det mulig å koble til en sentralisert utvendig, akustisk, visuell eller logikkstyrt alarm, f. eks. PLC.

3.4.3 Fjernstyrt ON/OFF

Alle vannkjølerne kan ha en fjernstyrt igangsetting eller stans (avsnittet 7.):

- For å aktivere fjernkontrollen rif. n.16387

- Som referansevariabel PÅ/AV rif.n.8996

Merk: Ikke aktiver "Sup" og "Re" sammen.

For tilkobling av utvendig PÅ/AV-bryter, se elektrisk skjema (avsnittet 7.))

3.5 Vannversjon (W)

Kjølerne i versjonen med vannkondensering har behov for en hydraulisk krets som fører kaldt vann til kondensatoren.

Vannversjonen av kjøleren er utstyrt med en pressostat-ventil på inntaket til kondensatoren, som har som funksjon å regulere vanntilførselen slik at man alltid oppnår en optimal kondensering.

Innledende kontroller

Dersom vanntilførselen til kondensatoren skjer via en lukket krets, må man foreta de innledende kontrollene som er oppgitt for hovedhydraulikkretsen (avsnitt 3.3.1).



Tilkobling

- Kondensvannkretsen bør utstyres med avstengningsventiler, slik at maskinen kan kobles fra i forbindelse med vedlikehold.
- Koble vanntilførsels- og avløpsrørene til koblingene bak på enheten.
- Dersom kondensvannet brukes kun én gang, anbefales det å utstyre kretsen med et filter på kondensatorens inntaksside, slik at man ikke risikerer at overflatene blir skitne.
- Dersom kretsen er av lukket type, må man forsikre seg om at den er helt full av vann og er korrekt utluftet.

4 Kontroll

4.1 Kontrollpanel



















-  OPP-knapp: trykk for trinnsvis å øke verdien for en valgt redigerbar parameter.
-  NED-knapp: trykk for trinnsvis å redusere verdien for en valgt redigerbar parameter.
-  ESC-knapp : for å avslutte uten å lagre; går tilbake til forrige nivå;

TRYKKES I 5 sek. ALARMNULLSTILLING.

-  SET-knapp: for å forlate og lagre/bekreftede verdi, gå til neste nivå, gå inn i Set-meny, **TRYKKET I 5 s. START KJØLER.**

4.2 Symbolenes betydning

Symbol	Symbolstatus	funksjon	Symbol	Symbolstatus	funksjon	
	Tent	Kompressor PÅ		Tent	Temperaturverdi	
	Blinker	Kompressor stand_by				
	Av	Kompressoren Av				
	Tent	Alarm til stede		Tent	Trykkverdi	
	Blinker	Advarsel eller Alarm kan tilbakestilles				
	Av	Ingen alarm				
	 Tent	Pumpe 1 PÅ		 Tent	Frostvæskevarmer på	
	Av	Pumpe 1 av		Av	Frostvæskevarmer av	
	 Tent	Pumpe 2 PÅ (ikke til stede)		 Tent	Veivhusvarmer PÅ Kompressor 1	
	Av	Pumpe 2 av (ikke til stede)		Av	Veivhusvarmer av Kompressor 1	
	 Tent	Pumpe 2 PÅ (ikke til stede)		 Tent	Veivhusvarmer PÅ Kompressor 2 (ikke til stede)	
	Av	Pumpe 2 av (ikke til stede)		Av	Veivhusvarmer av Kompressor 2 (ikke til stede)	

4.3 Starte kjøleren

- Koble strømforsyningen til maskinen ved å dreie hovedisolatorbryteren QS til PÅ.
- Trykk på knappen "set" for å starte.
- Still inn ønsket temperatur på kontrollen. (par. 4.5.1)

Fasemonitor

Dersom displayet viser alarmen "E-23", må brukeren kontrollere at ledningene på inngangsterminale er koblet korrekt til tørkerens strømbryter.

4.3.1 Justering ved oppstart

- Temperaturinnstilling. Se avsnitt 4.5 for å tilpasse til ny innstilling.
- Regulering av pumpe
Bekreft at pumpen fungerer korrekt ved å trykke på trykkmåleren (avles P1 og P0) og kontroller trykkets grenseverdier (Pmaks og Pmin) som er angitt på pumpens merkeplate.
P1 = trykk med pumpe PÅ
P0 = trykk med pumpe AV
 $Pmin < (P1 - P0) < Pmaks$
- Eksempel n°1.
Betingelser:
lukket krets, trykk P0 = 2 bar
pumpens merkeplateverdier: Pmin 1 bar/ Pmaks 3 bar
juster ventilutgangen for å få et trykk på 3 bar < P1 < 5 bar
- Eksempel n°2.
Betingelser:
åpen krets, trykk P0 = 0 bar
pumpens merkeplateverdier: Pmin 1 bar/ Pmaks 3 bar
juster ventilutgangen for å få et trykk på 1 bar < P1 < 3 bar
- Bekreft på samme måte at pumpen fungerer korrekt under normale kjørebetingelser. Kontroller også at pumpens strømsstyrke er innenfor grensene som er angitt på merkeplaten.
- Slå av kjøleren, og fortsett å fylle opp den hydrauliske kretsen ved "SET"-temperatur.
- Kontroller at temperaturen på det "behandlede" vannet ikke faller til under 5 °C og at omgivelsestemperaturen som den hydrauliske kretsen drives i ikke faller til under 5 °C. Hvis temperaturen er for lav, tilsettes passende mengde glykol som forklart under avsnittet 3.3.2

 **OBS!** Før du slår kjølepumpen på, må du stenge vannets utløpsventil (installeres hos kunden). La alltid innløpsventilen (installeres hos kunden) være åpen.
Når du slår pumpen på, åpner du kjølevannets utløpsventil langsomt og justerer strømningsmengden som beskrevet under punkt 4.3.1.

4.3.2 Starter med vann med høy temperatur

Hvis vanntemperaturen i kretsen er høy (f.eks. 30–35 °C), må avstengningsventilen (installert av kunden) ved utløpet av kjøleren gradvis lukkes (men ikke helt, omtrent to tredjedeler!) for å redusere vannstrømmen gjennom enheten. Åpne ventilen gradvis så snart vanntemperaturen synker til driftsverdien.

Viktig: I denne tilstanden kan det oppstå flere høytrykksalarmer som må tilbakestilles manuelt.
Viktig: Denne justeringen lar deg også unngå vannslag langs rørene på grunn av luftlommer i kretsen (luftlommer må fjernes gjennom lufteventiler på de høyeste punktene i den hydrauliske kretsen installert av kunden).

4.4 Stoppe kjøleren

Når kjøleren ikke skal drives lenger, slås den av som følger: Trykk på knappen "set" (5 sek.).
Ikke slå av hovedbryteren QS for å sikre at antifrost-beskyttelsen fremdeles mottar elektrisk strøm.

4.5 Parameterinnstillinger

Generelt

Det er to nivåer av beskyttelse for parametre:

- Direkte User-(U): med øyeblikkelig tilgang, **kan endres av bruker**,
- Passordbeskyttet Service-(S): passord påkrevd for tilgang, **(kan ikke endres)**.

4.5.1 Kjølerparametere (CF9)

PARAMETER	KODE	TYPE	STANDARD
Måleenhet.	R1	U	OFF
Styring av alarmrelé	CFJ1	U	0
Gjenoppretter fabrikkinnstillingene.	dEF	U	OFF
Fjern På/Av aktivere	R7	U	0
Programvareversjon	UEr	U	1.70
Enhetsadresse	CF30	U	1
Baudhastighet	CF31	U	5
Modbus-protokoll	CF32	U	1
Inspektør på/av aktivere	SUP	U	OFF
Dynamisk settpunkt muliggjøring	Erd	U	OFF

4.5.2 Temperaturkontroll (CTP)

PARAMETER	KODE	TYPE	STANDARD
Settpunkt for temperaturkontroll (standard)	SEt	U	13.0
Settpunkt for temperaturkontroll (presisjonskontroll)	SEt	U	20.0
Temperaturkontrolldifferensial (IKKE til stede i konfigurasjonen "presisjonskontroll")	dIF1	U	4.0

4.5.3 Vedlikeholdsparmetere (nnt)

PARAMETER	KODE	TYPE	STANDARD
Driftstimer for enhet	UH	U	
Driftstimer for enhet (X1000)	UHL	U	
Delvis driftstid for enhet	UPH	U	
Delvis driftstid for enhet (X1000)	UPHL	U	
Kompressorens driftstimer 1	CIH	U	
Kompressorens driftstimer 1 (x1000)	CIHL	U	

4.5.4 Probeparametere (bt 1, bt2)

Probe (bt 1)

PARAMETER	KODE	TYPE	STANDARD
Høy temperaturalarm (vann)	HR1	U	60

Probe (bt2)

PARAMETER	KODE	TYPE	STANDARD
Høy temperaturalarm (vann)	HR2	U	60







4.5.5 Alarmhistorikk (ALH 1)

PARAMETER	KODE	TYPE	STANDARD
Alarmnummer	HYS0	U	
Se alarmkode	HYS0	U	
Se dag og måned for alarmen	HYSd	U	
Se time og minutter for alarmen	HYS0	U	
bt1 temperatur ved alarmtidspunktet	HYS1	U	
bt2 temperatur ved alarmtidspunktet	HYS2	U	
SET-forhold ved alarmtidspunktet	HYS3	U	









4.6 Endre parametere (User)

4.6.1 Kjølerparametere «CF9»

Måleenhet.

Slå kjøleren «ON» ved hjelp av hovedfrakoblingsbryteren QS, og vent på at indikasjonen «OFF» vises. Trykk på knappene «esc» «set» samtidig for å gå inn på "U"-parametere.	
Parameteren «PAr» vises. Trykk på knappen «set» for å gå inn.	
Parameteren «CF9» vises. Trykk på knappen «set» for å gå inn.	
Parameteren «A I» vises. Trykk på knappen «set» for å gå inn	
Standardverdien er «0FF» = °C 0FF: temperatur = C°, Celsius ; trykk = Bar; 0n: temperatur = °F, Fahrenheit; Trykk = PSI	
Trykk på knappen «set» for å bekrefte.	
Returnerer automatisk til «A I» Parameteren er nå lagret. Trykk på knappen «esc» for å forlate, tre ganger.	







Alarmstyring

Slå kjøleren «ON» ved hjelp av hovedfrakoblingsbryteren QS, og vent på at indikasjonen «OFF» vises. Trykk på knappene «esc» «set» samtidig for å gå inn på "U"-parametere.	
Parameteren «PAr» vises. Trykk på knappen «set» for å gå inn.	
Parameteren «CF9» vises. Trykk på knappen «set» for å gå inn.	
Parameteren «A I» vises. Bruk knappene «down» og «up» for å velge «CFJ I»-parameter.	
Trykk på knappen «set» for å gå inn.	
Standardverdien er «0» Bruk knappene «down» og «up» for å velge alarmreléstyring (par. 4.5.1- Tab.1)	
Trykk på knappen «set» for å bekrefte.	
Returnerer automatisk til «CFJ I» Parameteren er nå lagret. Trykk på knappen «esc» for å forlate, tre ganger.	





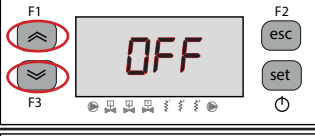

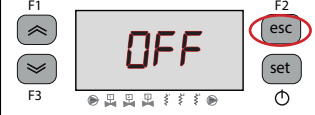

Tab.1 alarmreléstyring (CFJ I.)

0	Relé vanligvis deaktivert, aktiveres av en alarm.
1	Relé vanligvis aktivert (også med kontroll OFF), deaktivert av en alarm.
2	Relé vanligvis aktivert (kun med kontroll ON), deaktivert av en alarm eller med kontroll OFF.

Standardparametere

Slå kjøleren «ON» ved hjelp av hovedfrakoblingsbryteren QS, og vent på at indikasjonen «OFF» vises. Trykk på knappene «esc» «set» samtidig for å gå inn på "U"-parametere.	
Parameteren «PA _r » vises. Trykk på knappen «set» for å gå inn.	
Parameteren «CF ₉ » vises. Trykk på knappen «set» for å gå inn.	
Parameteren «A ₁ » vises. Bruk knappene «>>» og «<<» for å velge «dEF»-parameter.	
Trykk på knappen «set» for å gå inn.	
Standardverdien er «OFF» Bruk knappene «>>» og «<<» for å endre fra «OFF» til «On».	
Trykk på knappen «set» for å bekrefte.	
Gå tilbake til «OFF» etter noen sekunder. Parametrene ble automatisk tilbakestilt. Trykk på knappen «esc» for å forlate, tre ganger.	







Ekstern ON/OFF

Slå kjøleren «ON» ved hjelp av hovedfrakoblingsbryteren QS, og vent på at indikasjonen «OFF» vises. Trykk på knappene «esc» «set» samtidig for å gå inn på «U»-parametere.	
Parameteren «PA _r » vises. Trykk på knappen «set» for å gå inn.	
Parameteren «CF ₉ » vises. Trykk på knappen «set» for å gå inn.	
Parameteren «A ₁ » vises. Bruk knappene «>>» og «<<» for å velge «A ₇ »-parameter.	
Trykk på knappen «set» for å gå inn.	
Standardverdien er «0» Bruk knappene «>>» og «<<» for å velge modus: (par. 4.5.1- Tab.2)	
Trykk på knappen «set» for å bekrefte.	
Returnerer automatisk til «A ₇ » Parameteren er nå lagret. Trykk på knappen «esc» for å forlate, tre ganger.	









Tab.2. Fjern På/Av-modus (A₇)

0	Fjern På/Av deaktivert
1	Fjern På/Av aktivert sammen med lokal På/Av. I tilfelle strømbrudd eller hvis hovedbryteren slås av, må kjøleren startes igjen lokalt når strømmen kommer tilbake
2	Kun fjern På/Av, lokal På/Av deaktivert







Programvareversjon (skrivebeskyttet)

Slå kjøleren «ON» ved hjelp av hovedfrakoblingsbryteren QS, og vent på at indikasjonen «OFF» vises. Trykk på knappene « esc » « set » samtidig for å gå inn på «U«-parametere.	
Parameteren « PAR » vises. Trykk på knappen « set » for å gå inn.	
Parameteren « CF9 » vises. Trykk på knappen « set » for å gå inn.	
Parameteren « A » vises. Bruk knappene « ↓ » og « ↑ » for å velge « UEr »-parameter.	
Trykk på knappen « set » for å gå inn.	
Programvareversjonen vises	
Trykk på knappen « esc » for å forlate, tre ganger.	



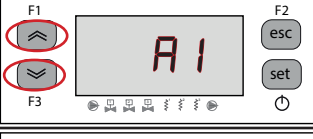



Inspektør aktivere

Slå kjøleren «ON» ved hjelp av hovedfrakoblingsbryteren QS, og vent på at indikasjonen «OFF» vises. Trykk på knappene « esc » « set » samtidig for å gå inn på "U"-parametere.	
Parameteren « PAR » vises. Trykk på knappen « set » for å gå inn.	
Parameteren « CF9 » vises. Trykk på knappen « set » for å gå inn.	
Parameteren « A » vises. Bruk knappene « ↓ » og « ↑ » for å velge « SUP »-parameter.	
Trykk på knappen « set » for å gå inn.	
Standardverdien er « OFF » Bruk knappene « ↓ » og « ↑ » for å endre.	
Trykk på knappen « set » for å bekrefte.	
Parameteren er nå lagret. Trykk på knappen « esc » for å forlate, tre ganger.	

Modbus (adresse)

Slå kjøleren «ON» ved hjelp av hovedfrakoblingsbryteren QS, og vent på at indikasjonen «OFF» vises. Trykk på knappene « esc » « set » samtidig for å gå inn på «U»-parametere.	
Parameteren « <i>PAR</i> » vises. Trykk på knappen « set » for å gå inn.	
Parameteren « <i>CF9</i> » vises. Trykk på knappen « set » for å gå inn.	
Parameteren « <i>A 1</i> » vises. Bruk knappene « ↓ » og « ↑ » for å velge « <i>CF30</i> »-parameter.	
Trykk på knappen « set » for å gå inn.	
Standardverdien er « <i>1</i> » Bruk knappene « ↓ » og « ↑ » for å endre adressen.	
Trykk på knappen « set » for å bekrefte.	
Parameteren er nå lagret. Trykk på knappen « esc » for å forlate, tre ganger.	

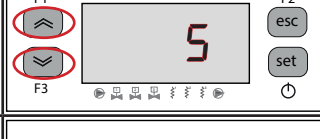





Modbus (overføringshastighet)

Slå kjøleren «ON» ved hjelp av hovedfrakoblingsbryteren QS, og vent på at indikasjonen «OFF» vises. Trykk på knappene « esc » « set » samtidig for å gå inn på «U»-parametere.	
Parameteren « <i>PAR</i> » vises. Trykk på knappen « set » for å gå inn.	
Parameteren « <i>CF9</i> » vises. Trykk på knappen « set » for å gå inn.	
Parameteren « <i>A 1</i> » vises. Bruk knappene « ↓ » og « ↑ » for å velge « <i>CF3 1</i> »-parameter.	
Trykk på knappen « set » for å gå inn.	
Standardverdien er « <i>5</i> » Bruk knappene « ↓ » og « ↑ » for å endre protokollen. (par. 4.5.1- Tab.3)	
Trykk på knappen « set » for å bekrefte.	
Parameteren er nå lagret. Trykk på knappen « esc » for å forlate, tre ganger.	

Tab.3 Overføringshastighet (valgfritt)(*CF3 1*)

1	2400	3	9600	5	38400	7	115200
2	4800	4	19200	6	57600		

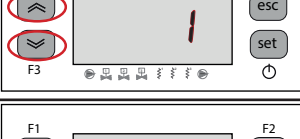
Modbus (protokoll)









Slå kjøleren «ON» ved hjelp av hovedfrakoblingsbryteren QS, og vent på at indikasjonen «OFF» vises. Trykk på knappene « esc » « set » samtidig for å gå inn på «U»-parametere.	
Parameteren «PAR» vises. Trykk på knappen « set » for å gå inn.	
Parameteren «CF9» vises. Trykk på knappen « set » for å gå inn.	
Parameteren «A 1» vises. Bruk knappene « ↓ » og « ↑ » for å velge «CF32»-parameter.	
Trykk på knappen « set » for å gå inn.	
Standardverdien er «1» Bruk knappene « ↓ » og « ↑ » for å endre overføringshastigheten. (par. 4.5.1- Tab.4)	
Trykk på knappen « set » for å bekrefte.	
Parameteren er nå lagret. Trykk på knappen « esc » for å forlate, tre ganger.	

Tab.4 Protokoll-modbus (valgfritt)(CF32)

1	PAR	2	INGEN	3	ODDE
---	-----	---	-------	---	------

 **Merk:** Hvis du endrer MODBUS-parametrene, må du slå AV kjøleren og deretter slå den PÅ igjen for å validere de nye parametrene.

ERD-aktivering

Slå kjøleren «ON» ved hjelp av hovedfrakoblingsbryteren QS, og vent på at indikasjonen «OFF» vises. Trykk på knappene « esc » « set » samtidig for å gå inn på «U»-parametere.	
Parameteren «PAR» vises. Trykk på knappen « set » for å gå inn.	
Parameteren «CF9» vises. Trykk på knappen « set » for å gå inn.	
Parameteren «A 1» vises. Bruk knappene « ↓ » og « ↑ » for å velge «ErD»-parameter.	
Trykk på knappen « set » for å gå inn.	
Standardverdien er «OFF» Bruk knappene « ↓ » og « ↑ » for å endre.	
Trykk på knappen « set » for å bekrefte.	
Parameteren er nå lagret. Trykk på knappen « esc » for å forlate, tre ganger.	

 **Med ERD-parameter aktivert:** Vannets innstilte temperatur endres med henvisning til omgivelsestemperaturen. Funksjonen er kun aktiv hvis temperaturpresisjonskontrollen er deaktivert (CPT=OFF).

4.6.2 Temperaturkontroll «CNP»

Innstilling for temperaturstyring

Slå kjøleren «ON» ved hjelp av hovedfrakoblingsbryteren QS, og vent på at indikasjonen «OFF» vises.

Trykk på knappene «esc» «set» samtidig for å gå inn på "U"-parametere.



Parameteren «PAR» vises.

Trykk på knappen «set» for å gå inn.



Parameteren «CF9» vises.

Bruk knappene «>>» og «<<» for å velge «CNP»-parameter.



Trykk på knappen «set» for å gå inn.



Parameteren «SEt» vises.

Trykk på knappen «set» for å gå inn.



Standardverdien er «13.0»

Bruk knappene «>>» og «<<» for å endre verdien.

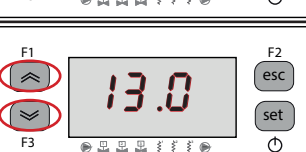

Trykk på knappen «set» for å bekrefte.

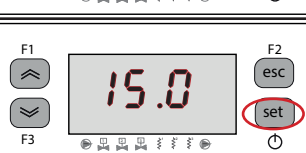

Parameteren er nå lagret.

Trykk på knappen «esc» for å forlate, tre ganger.



Viktig: Et sett med temperaturer mellom 1 °C og 5 °C, må utføres av spesialiserte teknikere som må bruke den spesifikke servicehåndboken for dette produktet.

Regulering av forskjellig temperatur

Slå kjøleren «ON» ved hjelp av hovedfrakoblingsbryteren QS, og vent på at indikasjonen «OFF» vises.

Trykk på knappene «esc» «set» samtidig for å gå inn på "U"-parametere.



Parameteren «PAR» vises.

Trykk på knappen «set» for å gå inn.

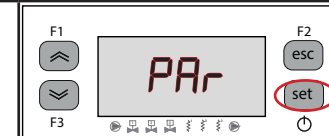

Parameteren «CF9» vises.

Bruk knappene «>>» og «<<» for å velge «CNP»-parameter.



Trykk på knappen «set» for å gå inn.



Parameteren «SEt» vises.

Bruk knappene «>>» og «<<» for å velge «d i F l»-parameter.



Trykk på knappen «set» for å gå inn.

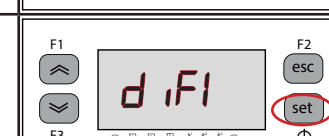

Standardverdien er «4.0»

Bruk knappene «>>» og «<<» for å endre verdien.



Trykk på knappen «set» for å bekrefte.

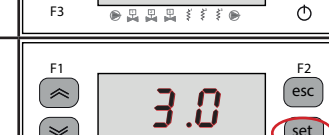

Parameteren er nå lagret.

Trykk på knappen «esc» for å forlate, tre ganger.

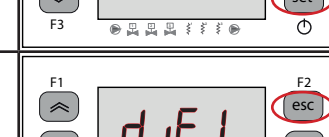

4.6.3 Probeparameter «bt l»

Probe «bt l».

Slå kjøleren «ON» ved hjelp av hovedfrakoblingsbryteren QS, og vent på at indikasjonen «OFF» vises.

Trykk på knappene «esc» «set» samtidig for å gå inn på «U»-parametere.



Parameteren «PAr» vises.

Trykk på knappen «set» for å gå inn.



Parameteren «CF9» vises.

Bruk knappene «>>» og «<<» for å velge «bt l»-parameter.



Trykk på knappen «set» for å gå inn.



Parameteren «HA l» vises.

Trykk på knappen «set» for å gå inn.



Standardverdien er «60.0»

Bruk knappene «>>» og «<<» for å endre verdien.



Trykk på knappen «set» for å bekrefte.



Parameteren er nå lagret.

Trykk på knappen «esc» for å forlate, tre ganger.



Samme sekvens for sonde «bt2».

4.7 Visualisering av sensor/ vifte/ Kompressor

Kjøler i drift.

Trykk på knappen «>>» for å se probene
bt 1, bt 2, bt 3, bP 1.....



Velg proben og vent noen sekunder. (Es. BT2)



Verdien av proben bt 2 vises.



Det er anbefales å alltid gå tilbake til probe bt 1



Beskrivelse:

bt 1 : lufttrykkmålere

bt 2 : temperatursensor fordampner

bt 3 : Omgivelsestemperaturføler

bt 10 : temperatursensor på elektrisk panel (option)

bP 1 : krets 1 transmitter

bP 2 : krets 2 transmitter; (fra modell ICEP080)

F... : viftedrift:

F... : vifte AV

F- : vifte 1 PÅ, fan 2,3 AV: (2 = fra modell ICEP022) (3 = fra modell ICEP080)

F-- : vifte 1 og 2 PÅ, fan 3 AV, (2 = fra modell ICEP022) (3 = fra modell ICEP080)

F--- : vifte 1,2 og 3 PÅ (fra modell ICEP080)

IC2 : kompressorenes drift:

IC_ : kompressorer deaktivert























IC- : kompressorer AV

IC- : kompressor 1 PÅ, kompressor 2 AV

IC2 : kompressorer 1 og 2 PÅ; (fra modell ICEP055)

IC- : med blinkende «1» kompressor klar til start, kompressor 2 AV

4.8 Stille inn klokkeslett/dato

Slå kjøleren «ON» ved hjelp av hovedfrakoblingsbryteren QS, og vent på at indikasjonen «OFF» vises. Trykk på knappene «  » og «  » samtidig for å gå inn på «Data/tid».	
Parameteren «FrEE» vises. Trykk på knappen «  » for å gå inn.	
Parameteren «A ₁ » vises. Bruk knappene «  » og «  » for å velge «CL»-parameter.	
Trykk på knappen «  » for å gå inn.	
Parameteren «HOUr» vises. Trykk på knappen i 5 sekunder «  ». Nå blinker parameteren.	
Bruk knappene «  » og «  » for å velge dato, time eller år som skal endres.	
Trykk på knappen «  » for å gå inn.	
Bruk knappene «  » og «  » for å endre verdien (es:år)	
Trykk på knappen «  » for å bekrefte.	

Bruk knappene «» og «» for å endre en annen verdi (es:dato)



Trykk på knappen «» for å forlate.
Parameteren slutter å blinke.













Trykk på knappene «» og «» samtidig for å gå ut.



⚠ Minnet for “klokkeslett / dato” har en maksimal varighet på tre dager, så dersom kontrollenheten er uten strøm i mer enn tre dager, vil innstilt klokkeslett / måned / år gå tapt. Juster klokken ved oppstart av maskinen, og ved behov.

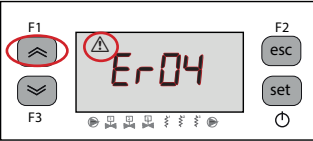
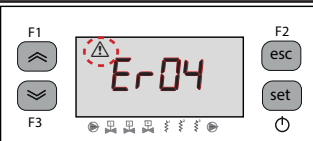





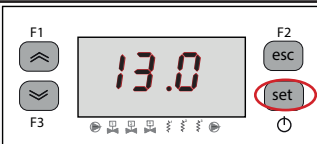

4.9 Alarmstyring

Når det oppstår en alarm, vises alarmkode og et symbol øverst til venstre  Kontinuerlig = alarm til stede Blinker = advarsel til stede / Alarm kan tilbakestilles	
Trykk på knappen «  » for å gå inn.	
Parameteren «ALH i» vises. Trykk på «  »-knappen for å velge «AL»-parameter.	
Trykk på knappen «  » for å gå inn.	
Kodealarmen vises: «Er04». Trykk på knappen «  » for å sjekke om det er flere alarmer til stede.	
Reparer feilen før du utfører tilbakestillingen. Når feilen er utbedret, begynner alarmsymbolet å blinke. Nå kan du utføre tilbakestillingen.	
trykk på knappen «  » til alarmen forsvinner.	

Alarm-/advarelliste

Kode	Beskrivelse	Handling	Nullstill
Er01	Svikt eller defekt i sensor bt1	Alarm	M
Er02	Svikt eller defekt i sensor bt2	Alarm	M
Er03	Svikt eller defekt i sensor bt3	Alarm	A
Er05	Svikt eller defekt i sensor bt10	Alarm	A
Er06	Svikt eller defekt i sensor bP2	Alarm	M
Er08	Høytrykksbryter krets1	Alarm	M
Er09	Lavtrykksbryter krets 1	Alarm	M
Er12	Høy temperatur bt1	Alarm	M
Er13	Lav temperatur bt1	Alarm	A
Er14	Høy temperatur bt2	Alarm	M
Er15	Lav temperatur bt2	Alarm	M
Er16	Høy temperatur bt3	Alarm	A
Er17	Lav temperatur bt3	Alarm	A
Er18	Varmebeskyttelse for kompressor 1	Alarm	M
Er20	Varmebeskyttelse for motor 1	Alarm	M
Er22	Lavt vannnivå / Differensialtrykksbryter	Alarm	M
Er23	Fasemonitor	Alarm	M
Er24	Utvidelsen er brutt eller frakoblet	Alarm	M
Er25	Overgår driftstimer for kompressor 1	Advarsel	M
Er27	Overgår enhetens driftstimer	Advarsel	M
Er28	Klokkeminne	Advarsel	A
Er29	Kjøleroppsett	Advarsel	A





4.10 Alarmlogg

Kjøler i drift. Trykk på knappen «  » for å se alarmhistorikken.	
Trykk på knappen «  » for å gå inn.	
Bruk knappene «  » og «  » for å se parametrene. (Par. 4.5.5)	
Trykk på knappen «  » for å se verdien.	

5 Vedlikehold

- Maskinen er utformet og fremstilt for å sikre kontinuerlig funksjon; komponentenes levetid avhenger imidlertid direkte av at vedlikeholdet utføres.
-  Ved bestilling av service eller reservedeler, må maskinen identifiseres (modell og serienummer) ved å avlese typeskiltet på utsiden av maskinen. (www.polewr.com.)

5.1 Generelle advarsler

-  Før det utføres noen form for vedlikehold, må man forsikre seg om at kjøleren er frakoblet strømmettet.
-  Bruk alltid originale reservedeler fra produsenten: ellers fritas produsenten fra ethvert ansvar for feilfunksjon på maskinen.
-  Ved kjølegasslekkasje må du tilkalle autorisert servicepersonell.
-  Schrader-ventilen skal benyttes kun ved feilfunksjon på maskinen: i motsatt tilfelle vil skader som skyldes gal lading av kjølevæske ikke dekkes av garantien.

5.2 Kjølevæske













Lading: eventuelle skader som skyldes gal ladeprosedyre av uautorisert personell dekkes ikke av garantien. 

-  Utstyret inneholder fluoriserte drivhusgasser. Kjølevæske R513A med normal temperatur og trykk er en fargeløs gass som hører til SAFETY GROUP A1 - EN378 (væske gruppe 2 ifølge direktiv PED 2014/68/EU); GWP (Global Warming Potential) = 629.

-  Hvis det lekker ut kjølevæske, må du lufte lokalet.

5.3 Forebyggende vedlikeholdsprogram

For å sikre at kjøleren alltid er effektiv og pålitelig, må du utføre:

Beskrivelse avvedlikehold	Maintenance Interval (standard operating conditions)			
	Hver dag	Hver 4. måned	Hver 12. måned	Hver 36. måned
<p style="text-align: center;">Inngrep</p> <p style="text-align: center;">kontroller  Service </p>				
Kontroller at indikatorlampen POWER ON lyser.				
Kontroller indikatorlampene på betjeningspanelet.				
Rengjør kondensatorribbene..				
Kontroller den elektriske absorpsjonen.				
Kontroller lekkasjer av kjølemiddel.				
Kontroller og rengjør Sikkerhetsvannventi(hvis til stede)*				
Kontroller elektriske system og det elektriske panelet kontrolleres.**				
Kontroller temperaturfølere. Skift ut ved behov.				 
Vedlikeholdssett				



Det finnes (se avsnitt 7.):

- servicesett: electrical kit; kompressor-sett; ventil-sett; fordampner-sett; pompe-sett; vanntank-sett;
- enkeltviser reservedeler.

*For at sikkerhetsventilene skal fungere optimalt, må de kontrolleres med jevne mellomrom.
Med tiden kan urenheter legge seg ved pluggen, og derfor er det nødvendig å spyle stussen med jevne mellomrom. En slik spyling gjøres ved at man manuelt tapper ventilen ved å vri knotten i pilens retning.

Viktig: Etter denne operasjonen må du forsikre deg om at driftstrykket er gjenopprettet.

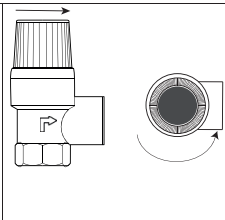



** I forbindelse med det periodiske vedlikeholdet må også maskinens elektriske system og det elektriske panelet kontrolleres i henhold til lokal lovgivning. I tillegg bør det alltid utføres en visuell inspeksjon av utstyret og de elektriske lederne der det er mulig, og det må også kontrolleres at

klemmene på strømkomponentene er korrekt tilstrammet i henhold til tiltrekkingsmomentene som er angitt i det elektriske diagrammet.

5.4 Avhending

Kjølevæsken og smøroljen i kretsen skal samles opp i henhold til de lokale miljøforskriftene. Gjenvinning av kjølevæsken blir utført før endelig kassering av apparatet ((EU) 517/2014 art.8).

	RESIRKULERING AVHENDING 
materiale i tre	stål/epoksyharpiks/polyester
tank	aluminium/kobber/stål
rør/opsamlingskanaler	kobber/aluminium/karbonstål
isoleringsrør	Nitrilgummi (NBR)
kompressor	stål/kobber/aluminium/olje
kondensator	stål/kobber/aluminium
pumpe	stål/støpejern/messing
vifte	aluminium
kjølevæske	R513A
ventiler	messing/kobber
el-kabler	kobber/PVC

Utstyr som inneholder elektriske komponenter må kastes separat sammen med elektrisk og elektronisk avfall i henhold til lokal og gjeldende lovgivning.



6 Feilsøking

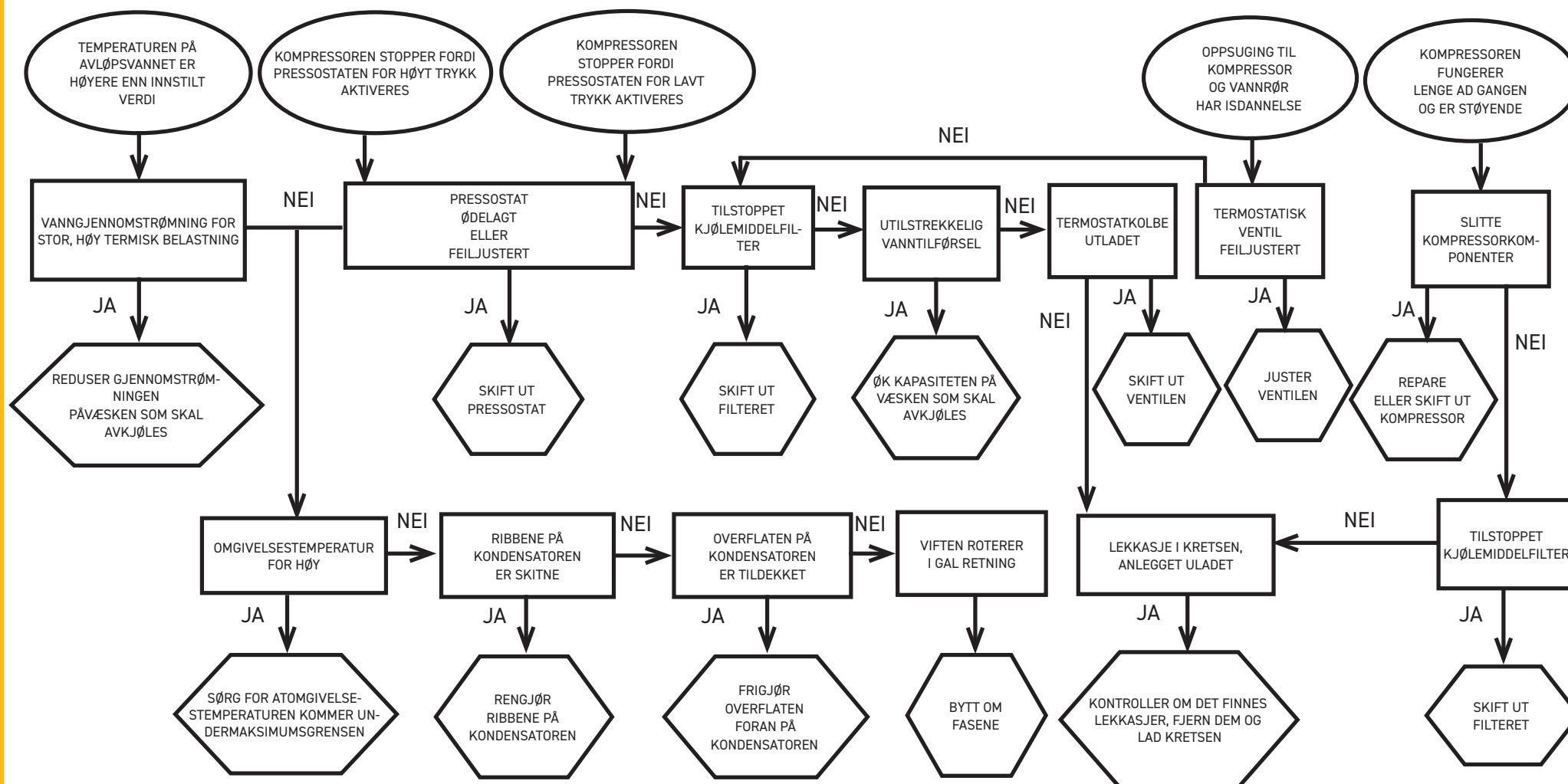
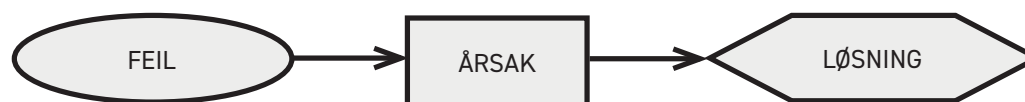

1 Veiligheid	2
1.1 Belang van de handleiding.....	2
1.2 Waarschuwingstekens.....	2
1.3 Veiligheidsaanwijzingen.....	2
1.4 Overig gevaar.....	2
2 Inleiding	3
2.1 Transport.....	3
2.2 Hantering.....	3
2.3 Inspectie.....	3
2.4 Opslag.....	3
3 Installatie	3
3.1 Werkruimte.....	3
3.2 Uitvoeringen.....	3
3.3 Hydraulisch circuit.....	3
3.3.1 Controles en aansluiting.....	3
3.3.2 Water en ethyleenglycol.....	4
3.3.3 Expansietank.....	4
3.4 Elektrisch circuit.....	5
3.4.1 Checks and connections.....	5
3.4.2 Algemeen alarm.....	5
3.4.3 ON/OFF met afstandsbediening.....	5
3.5 Uitvoering met water (W).....	5
4 Bediening	6
4.1 Bedieningspaneel.....	6
4.2 Betekenis symbolen.....	6
4.3 De koeler starten.....	6
4.3.1 Aanpassingen tijdens inbedrijfstelling.....	6
4.3.2 Beginnen met water met een hoge temperatuur.....	6
4.4 De koeler stoppen.....	7
4.5 Instellingen parameters.....	7
4.5.1 Parameters koeler (CF9).....	7
4.5.2 Temperatuurregeling (TRP).....	7
4.5.3 Onderhoudsparameters (PHL).....	7
4.5.4 Parameters sonde (b1, b2).....	7
4.5.5 Alarmgeschiedenis (ALH).....	7
4.6 Parameters wijzigen (User).....	8
4.6.1 Parameters koeler "CF9".....	8
4.6.2 Temperatuurregeling "TRP".....	13
4.6.3 Parameters sonde "b1".....	14
4.7 Weergave van sonde/ ventilator/ compressor.....	14
4.8 Instelling klok/datum.....	15
4.9 Alarmbeheer.....	16
4.10 Alarmgeschiedenis.....	17
5 Onderhoud	17
5.1 Algemene waarschuwingen.....	17
5.2 Koelvloeistof.....	17
5.3 Preventief onderhoudsprogramma.....	18
5.4 Afdanken.....	18

7 Bijlage

7.1 Legenda
7.2 Installatieschema
7.3 Hantering - Werkruimte
7.4 Technische gegevens
7.5 Afmetingen
7.6 Lijst vervangingsonderdelen
7.7 Explosietekeningen
7.8 Schema circuit
7.9 Schakelschema

1 Veiligheid

1.1 Belang van de handleiding

- Tijdens de gehele levensduur van de machine bewaren
- Voor iedere operatie eerst lezen
- Is onderhevig aan wijzigingen: voor bijgewerkte informatie de versie op de machine lezen.

1.2 Waarschuwingstekens



Instructies om gevaarlijke situaties voor personen te voorkomen.



Instructie om schade aan het apparaat te voorkomen.



Vereist de aanwezigheid van een ervaren en bevoegde technicus.



De betekenis van de aanwezige symbolen wordt verklaard in paragraaf 7.

1.3 Veiligheidsaanwijzingen



Iedere unit is met een veiligheidsschakelaar uitgerust om in veilige omstandigheden te kunnen werken. Maak altijd van deze voorzieningen gebruik om gevaarlijke situaties tijdens onderhoud te voorkomen.



Deze handleiding is bestemd voor de eindgebruiker en alleen voor werkzaamheden met gesloten panelen: ingrepen waarvoor Installatie/ inbedrijfstelling/onderhoud de machine met gereedschap moet worden geopend, mogen uitsluitend door ervaren en gekwalificeerd personeel worden uitgevoerd.



Uitsluitend voor installatie op plaatsen die niet toegankelijk zijn voor het grote publiek, hetzij op een beveiligde locatie met beperkte toegang, hetzij op een hoogte van ten minste 2,5 m of op beveiligde dakgedeelten, tenzij zij onder toezicht staan of instructies hebben gekregen over het gebruik van het apparaat door een persoon die verantwoordelijk is voor hun veiligheid.



De installatieafstand tot de muur en de vrije Bedieningsruimte worden aangegeven in paragraaf 7.3.



Let op: houd u aan de minimale/maximale temperatuur en druk zoals aangegeven in paragraaf 7.4 en het algemene bedrijfstemperatuurbereik zoals aangegeven in paragraaf 7.2.



Alle units kunnen buiten worden geïnstalleerd.



Alle elektrische aansluitingen dienen geheel in overeenstemming te zijn met de op de plaats van installatie geldende voorschriften.



Zorg ervoor de limieten op het gegevensplaatje niet te overschrijden.



De gebruiker dient andere belastingen dan de statische interne druk te voorkomen. In aardbevinggebieden moet de unit adequaat worden beschermd.

Gebruik de unit uitsluitend voor professionele doeleinden en voor het doel waarvoor deze is ontworpen.



Het is de taak van de gebruiker om alle aspecten van de toepassing waarin het product geïnstalleerd wordt te analyseren, en alle geldende veiligheidsnormen in de bedrijfstak en alle voorschriften met betrekking tot het product in de gebruiksaanwijzing en alle andere bij de unit geleverde documentatie op te volgen.

Het forceren of vervangen van een willekeurige component door onbevoegd personeel en/of het oneigenlijk gebruik van de unit ontheften de fabrikant van elke aansprakelijkheid en maken de garantie ongeldig.

Iedere huidige en toekomstige aansprakelijkheid voor schade aan personen, zaken en aan de unit zelf, die het gevolg zijn van nalatigheid van de operateurs, van het niet naleven van de instructies in deze handleiding, van het niet toepassen van de geldende voorschriften met betrekking tot de veiligheid van de installatie komt te vervallen.

De fabrikant aanvaardt geen aansprakelijkheid voor eventuele schade die te wijten is aan veranderingen en/of wijzigingen van de verpakking.

Het is de verantwoordelijkheid van de gebruiker om ervoor te zorgen dat de geleverde lijst voor het selecteren van de unit of van onderdelen en/of opties compleet is, teneinde een correct of redelijkerwijs voorspelbaar gebruik van de unit of van de onderdelen te garanderen.



LET OP: de fabrikant behoudt zich het recht voor de informatie in dit handboek zonder enige waarschuwing vooraf te wijzigen.

Voor volledige en actuele informatie raden wij de gebruiker aan het bij de fabrikant.

1.4 Overig gevaar

Installatie, start, uitschakelen en onderhoud van de machine mag uitsluitend uitgevoerd worden op grond van hetgeen beschreven staat in de technische documentatie en in elk geval zodanig dat gevaar vermeden wordt.

Onderstaande tabel vermeldt eventueel gevaar dat men tijdens het ontwerpen van de machine niet heeft kunnen voorkomen.

betreffend deel	bestaand gevaar	oorzaak	voorzorgsmaatregel
batterij voor warmteuitwisseling	kleine snijwonden	aanraking	vermijd aanraking, gebruik veiligheidshandschoenen
ventilatorrooster en ventilator	persoonlijk letsel	steken van scherpe voorwerpen in het rooster terwijl de ventilator beweegt	steek nooit voorwerpen in het ventilatorrooster en leg niets op de roosters

betreffend deel	bestaand gevaar	oorzaak	voorzorgsmaatregel
in de machine: compressor en toevoerleiding	brandwonden	aanraking	vermijd aanraking, gebruik veiligheidshandschoenen
in de machine: metaaldelen en elektrische kabels	vergiftiging, fulgoratie, ernstige brandwonden	slecht geïsoleerde voedingskabels naar elektrisch schakelbord van de unit met onder spanning staande metaaldelen	voer de elektrische isolatie van de voedingslijn naar behoren uit; voer de aarding van de metaaldelen nauwkeurig uit
uiten de machine: omliggende ruimte	vergiftiging, ernstige brandwonden	brand tengevolge van kortsluiting of oververhitting van de voedingslijn naar het elektrisch schakelbord van de machine	kabelsectie en beveiligingssysteem van de elektrische voedingslijn in overeenstemming met de geldende normen

2 Inleiding

De motoren van de compressor, de pomp en de ventilator hebben een hittebeveiliging die hen beschermt tegen eventuele oververhitting.

2.1 Transport

De verpakte eenheid moet:

- in een verticale positie worden gehouden;
- beschermd worden tegen atmosferische invloeden;
- beschermd worden tegen botsingen en stoten.

2.2 Hantering

Gebruik een vorkheftruck die geschikt is voor het te tillen gewicht en vermijd botsingen tegen de verpakking.

2.3 Inspectie

- Alle eenheden zijn in de fabriek geassembleerd, van bedrading voorzien en met koelmiddel en olie gevuld en getest;
- controleer bij ontvangst de staat van de machine: protesteer geef eventuele schade gelijk aan bij het transportbedrijf;
- pak de eenheid uit in de buurt van de installatieplaats.

2.4 Opslag

- De verpakte eenheid op een schone plaats en beschermd tegen vocht en weersinvloeden opslaan.
- de units niet op elkaar zetten;
- de instructies van de verpakking opvolgen.

3 Installatie

 Voor een optimale installatie de aanwijzingen in de paragrafen 7. respecteren.

 Het geïnstalleerde product moet op passende wijze worden beschermd tegen brandgevaar (ref. EN378-3).

 **Het is raadzaam dat alle koelers worden voorzien van de juiste voorfiltering in de buurt van de waterinlaat naar de koeler (filtra graad : min.05mm; max1.0mm).**

 **Te koelen vloeistoffen**

De af te koelen vloeistoffen dienen compatibel te zijn met de gebruikte materialen.

Als vloeistoffen kunnen bijvoorbeeld worden gebruikt: **water of mengsels van water en ethyleen- of propyleenglycol.**

De te koelen vloeistof mag niet ontvlambaar zijn.

Als de te koelen vloeistoffen gevaarlijke bestanddelen bevatten (zoals bijvoorbeeld ethyleen/propyleenglycol) moet de eventuele vloeistof die uit een lek gestroomd is opgevangen worden, omdat deze schadelijk is voor het milieu. In geval van het leeglopen van het hydraulische circuit, dient u zich aan de geldende normen te houden en de vloeistof niet in het milieu te verspreiden.

3.1 Werkruimte

 **Zorg voor een vrije ruimte van 1,5 meter rondom de eenheid.**

Bij de modellen met verticale uitstoot van de condensatielucht moet minstens 2 meter ruimte boven de koeler worden vrijgehouden.

3.2 Uitvoeringen

Uitvoering met lucht (A)

Zorg dat er geen situaties van hercirculatie van de koellucht kunnen ontstaan.

Sluit de ventilatieroosters niet af.

Voor de uitvoeringen met axiale ventilator is de kanalisatie van de verbruikte lucht afgeraden.

Uitvoering met water (W)

Als het water naar de condensor in een open circuit zit, installeer dan een netfilter op de ingang van het condensatiewater.

Voor speciale soorten koelwater (gedeïoniseerd, gedemineraliseerd, gedistilleerd) zijnde standaardmaterialen die voor de condensor voorzien zijn mogelijk niet geschikt. Neem in dat geval contact op met de fabricant.

3.3 Hydraulisch circuit

3.3.1 Controles en aansluiting

 Zorg ervoor, alvorens de koelmachine aan te sluiten en het circuit te vullen, dat de leidingen geheel schoon zijn. Reinig ze grondig indien dit nodig is.

  **Als het hydraulische circuit een gesloten circuit is, er is een drukzichtig geregelde veiligheidsklep geïnstalleerd: 6 bar.**

 Het wordt aangeraden om altijd netfilters te installeren op de watertoevoer- en -afvoerleidingen.

 Voor gevallen waarin het hydraulisch circuit onderschept wordt door automatische kleppen, moet de pomp beveiligd worden met systemen ter voorkoming van waterslag.

 Indien het circuit voor lange periodes van stilstand geleegd wordt, is het aanbevolen om smervloeistof aan de rotor van de pomp toe te voegen om te voorkomen dat deze bij de volgende start blokkeert. Ga bij een geblokkeerde rotor als volgt te werk om hem handmatig te deblokken. Verwijder het achterste deksel van de pomp en draai de kunststof ventilator voorzichtig. Als de as nog geblokkeerd is, moet de ventilator worden verwijderd om direct op de as in te grijpen. Plaats de ventilator en het deksel weer zodra de rotor gedeblokkeerd is.

Voorafgaande controles

1. Controleer of de eventueel aangebrachte schakelbare kleppen van het hydraulisch circuit open zijn.
2. Betreft het een circuit van het gesloten type, controleer dan of er een expansievat met geschikt vermogen is aangebracht.

Aansluiting

1. Verbind de waterkoeler met de ingangs- en uitgangsledingen door middel van de aansluitingen die hiervoor op de achterkant van de unit zitten. Het wordt aangeraden om van flexibele aansluitingen gebruik te maken, zodat het systeem soepel blijft.
2. Vul het hydraulisch circuit via de betreffende vulaansluiting aan de achterkant van de koelmachine ().
3. De tank is uitgerust met een speciale ontluichtingsklep, die bij het vullen met de hand bediend moet worden. Mocht het hydraulisch systeem uit bepaalde hoger gelegen punten bestaan, dan moet er op die punten een ontluichtingsklep geïnstalleerd worden.
4. Het verdient aanbeveling de aan- en afvoerleidingen van een kraan te voorzien, zodat tijdens onderhoudswerkzaamheden de machine van het circuit kan worden losgekoppeld.
5. Als de chiller met open systeem werkt, dan moet de pomp op de inlaatzijde van het vat worden geïnstalleerd en op de uitlaatzijde van de chiller.

 **Waarschuwing (modellen 022-120): de machine is uitgerust met een automatische beveiliging voor de tank.**

Als de waterinlaat per ongeluk wordt gesloten terwijl de pomp draait en de wateruitlaat open is, zal er lucht in de tank komen met de waarschijnlijke tussenkomst van de niveausensor. Het hydraulische circuit moet worden ontluicht om de lucht te verwijderen.

Subsequent checks

1. Controleer of reservoir en circuit volledig met water gevuld en naar behoren ontluicht zijn.
2. Het hydraulische circuit moet altijd gevuld zijn. Hiertoe kan men regelmatig controleren en bijvullen; als alternatief kan de installatie van een automatische vulkit voorzien worden.

Kenmerken van het water

Installeer een netfilter op de inlaat van het water, indien de machine zonder filter is geleverd.

  Kenmerken van het water

Temperatuur	≥50°F (10°C)	CL ⁻	<50 ppm
ΔT IN/OUT	5-15°C	CaCO ₃	70-150 ppm
Max % glycol	50	O ₂	<0.1 ppm
Druk	43.5-145 PSig (3-10 barg)	Fe	<0.2 ppm

PH	7.5-9	NO ₃	<2 ppm
Elektrisch geleidings-vermogen	10-500 μS/cm	HCO ₃ ⁻	70-300 ppm
Verzadigingsgraad van Langelier	0-1	H ₂ S	<0.05 ppm
SO ₄ ²⁻	<50 ppm	CO ₂	<5 ppm
NH ₃	<1 ppm	Al	<0.2 ppm

Voor speciale soorten water (gedeïoniseerd, gedemineraliseerd, gedistilleerd) zijn de standaard materialen die voor de koelmachine voorzien zijn mogelijk niet geschikt. Neem in dat geval contact op met de fabrikant.

3.3.2 Water en ethyleenglycol

Bevindt de machine zich buiten of in elk geval in een niet verwarmde omgeving, dan kan het voorkomen dat tijdens stilstand van de installatie in de koudste maanden van het jaar het water binnenin het circuit bevriest.

Om dit gevaar te verminderen:

- rust de koelmachine uit met geschikte, door de fabrikant als optie meegeleverde antivriesbeveiliging;
- laat de installatie in geval van langdurige stilstand leeglopen met behulp van de betreffende uitlaatklep;
- voeg een geschikte hoeveelheid antivries toe aan het water in circulatie (zie tabel).

Temperatuur afvoerwater [°C]	Ethyleenglycol (% vol.)	Omgevings-temperatuur
4	5	-2
2	10	-5
0	15	-7
-2	20	-10
-4	25	-12
-6	30	-15
-10	40	-20

3.3.3 Expansietank

Om te voorkomen dat tengevolge van toename/afname van het vloeistofvolume, veroorzaakt door aanzienlijke temperatuurschommelingen, schade ontstaat aan machine of circuit, is het raadzaam een expansievat met het juiste vermogen aan te brengen.

Het expansievat dient te worden geïnstalleerd aan de zuigzijde van de pomp op de aansluiting achterop de tank.

Maak voor het berekenen van het minimum volume van het op een gesloten circuit aan te brengen expansievat gebruik van onderstaande formule:

$$V=2 \times V_{tot} \times (P_{t \text{ min}} - P_{t \text{ max}})$$

waar

V_{tot} = tot. volume van het circuit (in liter)

$P_{t \text{ min}}/P_{t \text{ max}}$ = soortelijk gewicht bij de hoogst/laagst bereikbare watertemperatuur [kg/dm³].

Onderstaande tabel geeft de waarden weer van het soortelijk gewicht op grond van temperatuur en glycolpercentage.

% glycol	Temperatuur [°C]						
	-10	0	10	20	30	40	50
0%	1.0024	1.0008	0.9988	0.9964	0.9936	0.9905	0.9869
10%	1.0177	1.0155	1.0130	1.0101	1.0067	1.0030	0.9989
20%	1.0330	1.0303	1.0272	1.0237	1.0199	1.0156	1.0110
30%	1.0483	1.0450	1.0414	1.0374	1.0330	1.0282	1.0230
40%	1.0636	1.0594	1.0525	1.0511	1.0461	1.0408	1.0350



Let op: Raadpleeg tijdens het vullen ook de laadgegevens van het expansievat.

Als de omgevingsluchttemperatuur bij de koelmachine lager is dan -10°C, moet u het expansievat naar een beschermde omgeving verplaatsen, dicht bij de waterretourzijde van de koelmachine. De veiligheidsklep en ontluichtingsklep moeten bij de koelmachine blijven.

3.4 Elektrisch circuit

3.4.1 Checks and connections



Controleer of er geen spanning aanwezig is alvorens te beginnen met werken aan elektrische componenten.

Alle elektrische aansluitingen dienen geheel in overeenstemming te zijn met de op de plaats van installatie geldende voorschriften.

Voorafgaande controles

1. De netspanning en -frequentie dienen overeen te komen met de waarden op het typeplaatje van de koelmachine. De voedingsspanning mag, zelfs niet kortstondig, buiten de tolerantiewaarden van het elektrisch schema vallen: deze waarden bedragen, mits anders vermeld, +/- 10% voor de spanning; +/- 1% voor de frequentie.
2. De spanning dient symmetrisch te zijn (effectieve waarden van de spanning en fasehoeken tussen opeenvolgende fasen aan elkaar gelijk]. De maximaal toegestane spanningsverschil is 2%.

Aansluiting

1. De elektrische voeding van de koelmachine vindt plaats via een 4-dradige kabel, 3 polen + aarde, zonder nulleder. Zie voor de minimale kabeldoorsnede paragraaf 7.
2. Steek de kabel door de draadleider op het achterpaneel van de machine en sluit fase en neutraal aan op de klemmen van de algemene scheidingsschakelaar (QS); sluit de aarde op de betreffende aardklem aan (PE).
3. Breng bij het begin van de voedingskabel een beveiliging aan van minstens IP2X of IPXXB voor in geval van aanraking.
4. Installeer op de elektrische voedingslijn van de koelmachine een automatische schakelaar met (RCCB - IDn = 0.3A) differentiaal, met een maximum vermogen volgens het elektrisch referentieschema en een onderbrekingsvermogen dat afgestemd is op de bestaande kortsluitstroom in de ruimte waar de machine zich bevindt.
De nominale stroom "In" van deze installatieautomaat moet gelijk zijn aan FLA en de D-curve.
5. De maximum impedantiewaarde van het net = 0.274 ohm.

Volgende controles

Zorg ervoor dat koelmachine en hulpapparatuur geaard zijn en beveiligd tegen kortsluiting en/of overbelasting.



Wanneer de unit aangesloten is en de hoofdschakelaar aan het begin gesloten is (waardoor er

spanning op de machine staat), kunnen de voltagedaarden in het elektrisch circuit gevaarlijk hoog oplopen. Ga zeer behoedzaam te werk!



De installateur is er verantwoordelijk voor dat de verplichte minimale tests worden uitgevoerd om de correcte elektrische installatie te verzekeren, in overeenstemming met de plaatselijke regelgeving en in coördinatie met het relevante aardingssysteem, inclusief de specifieke vereisten voor geïsoleerde neutrale systemen (IT).

3.4.2 Algemeen alarm

Alle waterkoelers hebben de mogelijkheid machine-alarm te melden (zie het schakelschema); dit geschiedt via een vrij contact op het klemmenbord, waarmee een centraal extern alarm, geluids-, visueel of met logicafunctie, verbonden kan worden. PLC.

3.4.3 ON/OFF met afstandsbediening

Alle koelmachines beschikken over de mogelijkheid in- en uitgeschakeld te worden via afstandsbediening (paragraaf 7.).

- Om de externe rif. n.16387
- Als referentievariabele ON-OFF rif.n.8996

Let op: schakel "Sup" en "Re" niet samen in.

Voor aansluiting van het remote ON-OFF contact, zie het schakelschema (paragraaf 7.)

3.5 Uitvoering met water (W)

Voor de chillers in de uitvoering met watercondensatie is een hydraulisch circuit nodig dat koud water naar de condensor voert.

De chiller in de wateruitvoering is voorzien van een drukklep op de ingang naar de condensor, die tot taak heeft de hoeveelheid water zo te regelen dat er altijd een optimale condensatie wordt bewerkstelligd.

Controles vooraf

Als de watertoevoer naar de condensor wordt gerealiseerd via een gesloten circuit, moeten alle voorafgaande controles worden uitgevoerd die worden genoemd voor het hydraulische hoofdcircuit (par. 3.3.1).

Aansluiting

1. Het is raadzaam het condensatiewatercircuit te voorzien van stopkranen, om de machine te kunnen uitsluiten als er onderhoud moet worden gepleegd.
2. Verbind de toevoer -/ en retourleidingen van het water met de aansluitingen die hiervoor op de achterkant van de unit zitten.
3. Als het condensatiewater na gebruik wordt afgevoerd, wordt geadviseerd het circuit te voorzien van een filter aan de ingang van de condensor, om minder risico te lopen dat de oppervlakken vervuild raken.
4. Als het circuit een gesloten circuit is, moet worden nagegaan of het goed gevuld is met water, en of het goed ontluicht is.

4 Bediening

4.1 Bedieningspaneel



Toets OMHOOG: druk om de waarde van een geselecteerde, bewerkbare parameter te verhogen.



Toets OMLAAG: druk om de waarde van een geselecteerde, bewerkbare parameter te verlagen.



Toets ESC: om af te sluiten zonder op te slaan; keert terug naar het vorige niveau;

INGEDRUKT GEDURENDE 5 sec. RESETTEN ALARM.



Toets SET: om af te sluiten en de waarde op te slaan/te bevestigen; gaat naar het volgende niveau; openen menu Set; **INGEDRUKT GEDURENDE 5 sec. START KOELER.**

4.2 Betekenis symbolen

Symbol	Status symbool	functie	Symbol	Status symbool	functie
	Brandt	Compressor ON		Brandt	Temperatuurwaarde
	Knippert	Compressor in stand-by		Brandt	Drukwaarde
	Uit	Compressor OFF			Brandt
	Brandt	Alarm aanwezig		Uit	Antivriesverwarming OFF
	Knippert	Waarschuwing of Alarm kan gereset worden		Brandt	Carterverwarming ON Compressor 1
	Uit	Geen alarm		Uit	Carterverwarming OFF Compressor 1
	Brandt	Pomp 1 ON		Brandt	Carterverwarming ON Compressor 2 (niet aanwezig)
	Uit	Pomp 1 OFF		Uit	Carterverwarming OFF Compressor 2 (niet aanwezig)
	Brandt	Pomp 2 ON (niet aanwezig)		Uit	Carterverwarming OFF Compressor 2 (niet aanwezig)
	Uit	Pomp 2 OFF (niet aanwezig)			

4.3 De koeler starten

1. Sluit de voeding naar de machine aan door de hoofdschakelaar QS in de stand AAN te zetten.
2. Druk op de toets "set" om te starten.
3. Stel de gewenste temperatuur in met de bediening. (par. 4.5.1)

Fasebewaker

Als bij het starten van op het display het alarm "E-23" verschijnt, moet worden gecontroleerd of de bedrading van de ingangsklemmen naar de scheidingsschakelaar van correct is uitgevoerd.

4.3.1 Aanpassingen tijdens inbedrijfstelling

1. Temperatuurinstelling: zie paragraaf 4.5 om een nieuwe instelling te gebruiken.
2. Regeling van de pomp
 - Controleer de goede werking van de pomp, gebruik de drukmeter (lees P1 en P0) en controleer de druklimietwaarden (Pmax en Pmin) op het typeplaatje van de pomp.
 - P1 = druk met pomp AAN
 - P0 = druk met ppmp UIT
 - $P_{min} < (P1 - P0) < P_{max}$
 - Voorbeeld nr. 1.
 - Voorwaarden: gesloten circuit, druk P0 = 2 bar
 - waarden typeplaatje pomp: Pmin 1 bar/ Pmax 3 bar
 - pas de klepuitlaat aan om een druk van 3 bar < P1 < 5 bar te verkrijgen
 - Voorbeeld nr. 2.
 - Voorwaarden: open circuit, druk P0 = 0 bar
 - waarden typeplaatje pomp: Pmin 1 bar/ Pmax 3 bar
 - pas de klepuitlaat aan om een druk van 1 bar < P1 < 3 bar te verkrijgen
3. Controleer de goede werking van de pomp ook onder normale bedrijfsomstandigheden. Controleer ook dat het aantal ampère van de pomp binnen de limieten op het typeplaatje ligt.
4. Schakel de koeler uit en vul het hydraulisch circuit bij met de ingestelde ("SET") temperatuur.
5. Controleer dat de temperatuur van het "behandelde" water niet onder 5°C daalt en dat de omgevingstemperatuur waarin het hydraulisch circuit werkt niet onder 5°C daalt. Als de temperatuur te laag is, voegt u de juiste hoeveelheid glycol toe, zoals wordt uitgelegd in paragraaf 3.3.3.

LET OP! voordat u de koelpomp inschakelt, dient u de wateruitlaatklep (te installeren door de klant) te sluiten.

Houd de inlaatklep (te installeren door de klant) altijd open.

Open bij het inschakelen van de pomp langzaam de wateruitlaatklep van de koeler en stel het debiet in zoals beschreven in punt 4.3.1.

4.3.2 Beginnen met water met een hoge temperatuur

Als de watertemperatuur in het circuit hoog is (bijvoorbeeld 30-35 °C), sluit dan geleidelijk (maar niet volledig, ongeveer twee derde!) de (door de klant geïnstalleerde) afsluiter aan de uitlaat van de koelmachine om de waterstroom door de unit te verminderen. Open de afsluiter geleidelijk zodra de watertemperatuur daalt tot de bedrijfstemperatuur.

Belangrijk: in deze situatie kunnen er meerdere hogedrukalarmen optreden die handmatig moeten worden gereset.

Belangrijk: met deze afstelling voorkomt u ook waterslag in de leidingen als gevolg van luchtballen in het circuit (luchtballen moeten worden verwijderd via ontluchtingsventielen op de hoogste punten in het hydraulische circuit, door de klant geïnstalleerde).

4.4 De koeler stoppen

Wanneer de koeler niet meer moet werken, schakelt u de koeler als volgt uit: Druk op de toets "set" (5 sec.).

Zet de hoofdschakelaar QS niet uit, om te garanderen dat de beveiligingsinrichtingen tegen bevriezing nog steeds van stroom worden voorzien.

4.5 Instellingen parameters

Algemeen

Er zijn twee beveiligingsniveaus voor parameters:

- Direct User-(U): met rechtstreekse toegang, **kan gewijzigd worden door de gebruiker**;
- Beveiligd met wachtwoord Service-(S): wachtwoord vereist voor toegang, **(kan niet gewijzigd worden)**.

4.5.1 Parameters koeler (CF9)

PARAMETER	CODE	TYPE	STAN-DAARD
Meeteenheid.	R1	U	OFF
Beheer alarmrelais	CFJ1	U	0
Reset standaard parameters	DEF	U	OFF
Activering externe in-/uitschakeling	R7	U	0
Softwareversie	UER	U	1.7.0
Adres eenheid	CF30	U	1
Baudrate	CF31	U	5
Modbus-protocol	CF32	U	1
Activering aan/uit supervisor	SUP	U	OFF
Activering dynamisch setpoint	Er d	U	OFF

4.5.2 Temperatuurregeling (CTP)

PARAMETER	CODE	TYPE	STAN-DAARD
Setpoint temperatuurregeling (standaard)	SET	U	13.0
Setpoint temperatuurregeling (precisieregeling)	SET	U	20.0
Regeling temperatuurverschil (NIET aanwezig bij configuratie "precisieregeling")	d1 F1	U	4.0

4.5.3 Onderhoudsparameters (Pnt)

PARAMETER	CODE	TYPE	STAN-DAARD
Bedrijfsuren eenheid	UH	U	-
Bedrijfsuren eenheid (x1000)	UHL	U	-
Gedeeltelijke bedrijfsuren eenheid	UPH	U	-

PARAMETER	CODE	TYPE	STAN-DAARD
Gedeeltelijke bedrijfsuren eenheid (x1000)	UPHL	U	-
Bedrijfsuren compressor 1	CIH	U	-
Bedrijfsuren compressor 1 (x1000)	CIHL	U	-

4.5.4 Parameters sonde (bt 1, bt2)

Sonde (bt 1)

PARAMETER	CODE	TYPE	STAN-DAARD
Alarm hoge temperatuur (water)	HR1	U	60

Sonde (bt2)

PARAMETER	CODE	TYPE	STAN-DAARD
Alarm hoge temperatuur (water)	HR2	U	60







4.5.5 Alarmgeschiedenis (ALH 1)

PARAMETER	CODE	TYPE	STAN-DAARD
Alarmnummer	HYS P	U	-
Weergave alarmcode	HYS C	U	-
Weergave dag en maand van het alarm	HYS d	U	-
Weergave uur en minuten van het alarm	HYS t	U	-
bt1 temperatuur op het moment van het alarm	HYS 1	U	-
bt2 temperatuur op het moment van het alarm	HYS 2	U	-
Ingestelde voorwaarden (SET) op het moment van het alarm	HYS 3	U	-







4.6 Parameters wijzigen (User)

4.6.1 Parameters koeler "CF9"

Meeteenheid.

Schakel de koeler in "ON" met de hoofdschakelaar QS, en wacht op de weergave van de aanduiding "OFF". Druk tegelijkertijd op de toetsen "esc" "set" om parameters "U" te openen.	
Parameter "PAR" verschijnt. Druk op de toets "set" om te openen.	
Parameter "CF9" verschijnt. Druk op de toets "set" om te openen.	
Parameter "R1" verschijnt. Druk op de toets "set" om te openen	
De standaardwaarde is "0FF" = °C Gebruik de toetsen "↓" en "↑" om de meeteenheid te selecteren. 0FF : temperatuur = C°, Celsius ; druk = Bar; 0n : temperatuur = °F, Fahrenheit; druk =PSI	
Druk op de toets "set" om te bevestigen.	
Keert automatisch terug naar "R1" De parameter is nu opgeslagen. Druk driemaal op de toets "esc" om af te sluiten.	

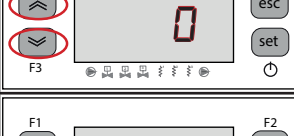
Alarmbeheer

Schakel de koeler in "ON" met de hoofdschakelaar QS, en wacht op de weergave van de aanduiding "OFF". Druk tegelijkertijd op de toetsen "esc" "set" om parameters "U" te openen.	
Parameter "PAR" verschijnt. Druk op de toets "set" om te openen.	
Parameter "CF9" verschijnt. Druk op de toets "set" om te openen.	
Parameter "R1" verschijnt. Druk op de toetsen "↓" en "↑" om de parameter "CFJ1" te selecteren.	
Druk op de toets "set" om te openen.	
De standaardwaarde is "0" Gebruik de toetsen "↓" en "↑" om het beheer alarmrelais te selecteren (par. 4.5.1- Tab.1)	
Druk op de toets "set" om te bevestigen.	
Keert automatisch terug naar "CFJ1" De parameter is nu opgeslagen. Druk driemaal op de toets "esc" om af te sluiten.	

Tab.1 Beheer alarmrelais (CFJ1.)

0	Relais normaal gedeactiveerd, geactiveerd door een alarm.
1	Relais normaal geactiveerd (ook bij bediening OFF), gedeactiveerd door een alarm.
2	Relais normaal geactiveerd (alleen bij bediening ON), gedeactiveerd door een alarm of bij bediening OFF.

Standaard parameters

<p>Schakel de koeler in "ON" met de hoofdschakelaar QS, en wacht op de weergave van de aanduiding "OFF".</p> <p>Druk tegelijkertijd op de toetsen "esc" "set" om parameters "U" te openen.</p>	
<p>Parameter "PRr" verschijnt.</p> <p>Druk op de toets "set" om te openen.</p>	
<p>Parameter "CF9" verschijnt.</p> <p>Druk op de toets "set" om te openen.</p>	
<p>Parameter "A i" verschijnt.</p> <p>Gebruik de toetsen "⏴" en "⏵" om de parameter "dEF" te selecteren.</p>	
<p>Druk op de toets "set" om te openen.</p>	
<p>De standaardwaarde is "OFF".</p> <p>Gebruik de toetsen "⏴" en "⏵" om van "OFF" te wijzigen naar "0n".</p>	
<p>Druk op de toets "set" om te bevestigen.</p>	
<p>Keert na een paar seconden terug naar "OFF".</p> <p>De parameters werden automatisch gereset.</p> <p>Druk driemaal op de toets "esc" om af te sluiten.</p>	







Externe ON/OFF

<p>Schakel de koeler in "ON" met de hoofdschakelaar QS, en wacht op de weergave van de aanduiding "OFF".</p> <p>Druk tegelijkertijd op de toetsen "esc" "set" om parameters "U" te openen.</p>	
<p>Parameter "PRr" verschijnt.</p> <p>Druk op de toets "set" om te openen.</p>	
<p>Parameter "CF9" verschijnt.</p> <p>Druk op de toets "set" om te openen.</p>	
<p>Parameter "A i" verschijnt.</p> <p>Gebruik de toetsen "⏴" en "⏵" om de parameter "A7" te selecteren.</p>	
<p>Druk op de toets "set" om te openen.</p>	
<p>De standaardwaarde is "0".</p> <p>Gebruik de toetsen "⏴" en "⏵" om de modus te selecteren: (par. 4.5.1- Tab.2)</p>	
<p>Druk op de toets "set" om te bevestigen.</p>	
<p>Keert automatisch terug naar "A7"</p> <p>De parameter is nu opgeslagen.</p> <p>Druk driemaal op de toets "esc" om af te sluiten.</p>	







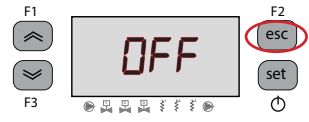

Tab.2 Modus externe inschakeling/uitschakeling (A7)

0	Externe inschakeling/uitschakeling gedeactiveerd
1	Externe inschakeling/uitschakeling geactiveerd, samen met lokale inschakeling/uitschakeling. In geval van stroomuitval, of als de hoofdschakelaar op uit wordt geplaatst, dan moet de koeler na de terugkeer van de voeding lokaal worden opgestart
2	Alleen externe inschakeling/uitschakeling, lokale inschakeling/uitschakeling gedeactiveerd









Softwareversie (alleen lezen)

<p>Schakel de koeler in "ON" met de hoofdschakelaar QS, en wacht op de weergave van de aanduiding "OFF".</p> <p>Druk tegelijkertijd op de toetsen "esc" "set" om parameters "U" te openen.</p>	
<p>Parameter "PRr" verschijnt.</p> <p>Druk op de toets "set" om te openen.</p>	
<p>Parameter "CF9" verschijnt.</p> <p>Druk op de toets "set" om te openen.</p>	
<p>Parameter "R i" verschijnt.</p> <p>Gebruik de toetsen "⏪" en "⏩" om de parameter "iUEr" te selecteren.</p>	
<p>Druk op de toets "set" om te openen.</p>	
<p>De softwareversie wordt weergegeven</p>	
<p>Druk driemaal op de toets "esc" om af te sluiten.</p>	







Activering supervisor

<p>Schakel de koeler in "ON" met de hoofdschakelaar QS, en wacht op de weergave van de aanduiding "OFF".</p> <p>Druk tegelijkertijd op de toetsen "esc" "set" om parameters "U" te openen.</p>	
<p>Parameter "PRr" verschijnt.</p> <p>Druk op de toets "set" om te openen.</p>	
<p>Parameter "CF9" verschijnt.</p> <p>Druk op de toets "set" om te openen.</p>	
<p>Parameter "R i" verschijnt.</p> <p>Gebruik de toetsen "⏪" en "⏩" om de parameter "SUP" te selecteren.</p>	
<p>Druk op de toets "set" om te openen.</p>	
<p>De standaardwaarde is "OFF"</p> <p>Gebruik de toetsen "⏪" en "⏩" om te wijzigen.</p>	
<p>Druk op de toets "set" om te bevestigen.</p>	
<p>De parameter is nu opgeslagen.</p> <p>Druk driemaal op de toets "esc" om af te sluiten.</p>	

Modbus (adres)

Schakel de koeler in "ON" met de hoofdschakelaar QS, en wacht op de weergave van de aanduiding "OFF". Druk tegelijkertijd op de toetsen "esc" "set" om parameters "U" te openen.	
Parameter "PAr" verschijnt. Druk op de toets "set" om te openen.	
Parameter "CF9" verschijnt. Druk op de toets "set" om te openen.	
Parameter "A i" verschijnt. Gebruik de toetsen "set" en "esc" om de parameter "CF30" te selecteren.	
Druk op de toets "set" om te openen.	
De standaardwaarde is "1". Gebruik de toetsen "set" en "esc" om het adres te wijzigen.	
Druk op de toets "set" om te bevestigen.	
De parameter is nu opgeslagen. Druk driemaal op de toets "esc" om af te sluiten.	

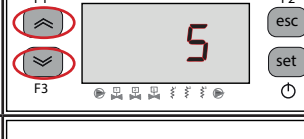
Modbus (baudrate)

Schakel de koeler in "ON" met de hoofdschakelaar QS, en wacht op de weergave van de aanduiding "OFF". Druk tegelijkertijd op de toetsen "esc" "set" om parameters "U" te openen.	
Parameter "PAr" verschijnt. Druk op de toets "set" om te openen.	
Parameter "CF9" verschijnt. Druk op de toets "set" om te openen.	
Parameter "A i" verschijnt. Gebruik de toetsen "set" en "esc" om de parameter "CF31" te selecteren.	
Druk op de toets "set" om te openen.	
De standaardwaarde is "5". Gebruik de toetsen "set" en "esc" om het protocol te wijzigen. (par. 4.5.1- Tab.3)	
Druk op de toets "set" om te bevestigen.	
De parameter is nu opgeslagen. Druk driemaal op de toets "esc" om af te sluiten.	

Tab.3 Baudrate (optioneel)(CF3 1)

1	2400	3	9600	5	38400	7	115200
2	4800	4	19200	6	57600		

Modbus (protocol)

<p>Schakel de koeler in "ON" met de hoofdschakelaar QS, en wacht op de weergave van de aanduiding "OFF".</p> <p>Druk tegelijkertijd op de toetsen "esc" "set" om parameters "U" te openen.</p>	
<p>Parameter "PAR" verschijnt.</p> <p>Druk op de toets "set" om te openen.</p>	
<p>Parameter "CF9" verschijnt.</p> <p>Druk op de toets "set" om te openen.</p>	
<p>Parameter "A i" verschijnt.</p> <p>Gebruik de toetsen "⏪" en "⏩" om de parameter "CF32" te selecteren.</p>	
<p>Druk op de toets "set" om te openen.</p>	
<p>De standaardwaarde is "1"</p> <p>Gebruik de toetsen "⏪" en "⏩" om de baudrate te wijzigen. (par. 4.5.1- Tab.4)</p>	
<p>Druk op de toets "set" om te bevestigen.</p>	
<p>De parameter is nu opgeslagen.</p> <p>Druk driemaal op de toets "esc" om af te sluiten.</p>	

Tab.4 Modbus-protocol (optioneel)(CF32)

1	EVEN	2	GEEN	3	ONEVEN
---	------	---	------	---	--------

Opmerking: als u de parameters MODBUS wijzigt, moet de koeler voor de validatie van de nieuwe parameters worden uitgeschakeld en weer ingeschakeld.

Activering ERD

<p>Schakel de koeler in "ON" met de hoofdschakelaar QS, en wacht op de weergave van de aanduiding "OFF".</p> <p>Druk tegelijkertijd op de toetsen "esc" "set" om parameters "U" te openen.</p>	
<p>Parameter "PAR" verschijnt.</p> <p>Druk op de toets "set" om te openen.</p>	
<p>Parameter "CF9" verschijnt.</p> <p>Druk op de toets "set" om te openen.</p>	
<p>Parameter "A i" verschijnt.</p> <p>Gebruik de toetsen "⏪" en "⏩" om de parameter "Er-d" te selecteren.</p>	
<p>Druk op de toets "set" om te openen.</p>	
<p>De standaardwaarde is "OFF"</p> <p>Gebruik de toetsen "⏪" en "⏩" om te wijzigen.</p>	
<p>Druk op de toets "set" om te bevestigen.</p>	
<p>De parameter is nu opgeslagen.</p> <p>Druk driemaal op de toets "esc" om af te sluiten.</p>	

Bij activering parameter ERD: De ingestelde watertemperatuur wijzigt onder verwijzing naar de omgevingstemperatuur. De functie is alleen actief als de precisie-regeling van de temperatuur gedeactiveerd is (CPT=OFF).

4.6.2 Temperatuurregeling "CNP"

Instelling temperatuurregeling

<p>Schakel de koeler in "ON" met de hoofdschakelaar QS, en wacht op de weergave van de aanduiding "OFF".</p> <p>Druk tegelijkertijd op de toetsen "esc" "set" om parameters "U" te openen.</p>	
<p>Parameter "PAR" verschijnt.</p> <p>Druk op de toets "set" om te openen.</p>	
<p>Parameter "CF9" verschijnt.</p> <p>Gebruik de toetsen "⏪" en "⏩" om de parameter "CNP" te selecteren.</p>	
<p>Druk op de toets "set" om te openen.</p>	
<p>Parameter "SEt" verschijnt.</p> <p>Druk op de toets "set" om te openen.</p>	
<p>De standaardwaarde is "13.0"</p> <p>Gebruik de toetsen "⏪" en "⏩" om de waarde te wijzigen.</p>	
<p>Druk op de toets "set" om te bevestigen.</p>	
<p>De parameter is nu opgeslagen.</p> <p>Druk driemaal op de toets "esc" om af te sluiten.</p>	

Belangrijk: Een temperatuurinstelling tussen 1°C en 5°C moet worden uitgevoerd door een gespecialiseerde technicus, die daarvoor de specifieke onderhoudshandeling van dit product moet gebruiken.

Regeling van het temperatuurverschil

<p>Schakel de koeler in "ON" met de hoofdschakelaar QS, en wacht op de weergave van de aanduiding "OFF".</p> <p>Druk tegelijkertijd op de toetsen "esc" "set" om parameters "U" te openen.</p>	
<p>Parameter "PAR" verschijnt.</p> <p>Druk op de toets "set" om te openen.</p>	
<p>Parameter "CF9" verschijnt.</p> <p>Gebruik de toetsen "⏪" en "⏩" om de parameter "CNP" te selecteren.</p>	
<p>Druk op de toets "set" om te openen.</p>	
<p>Parameter "SEt" verschijnt.</p> <p>Gebruik de toetsen "⏪" en "⏩" om de parameter "dIF I" te selecteren.</p>	
<p>Druk op de toets "set" om te openen.</p>	
<p>De standaardwaarde is "4.0"</p> <p>Gebruik de toetsen "⏪" en "⏩" om de waarde te wijzigen.</p>	
<p>Druk op de toets "set" om te bevestigen.</p>	
<p>De parameter is nu opgeslagen.</p> <p>Druk driemaal op de toets "esc" om af te sluiten.</p>	

4.6.3 Parameters sonde "bt 1"

Sonde "bt 1".

Schakel de koeler in "ON" met de hoofdschakelaar QS, en wacht op de weergave van de aanduiding "OFF". Druk tegelijkertijd op de toetsen "esc" "set" om parameters "U" te openen.	
Parameter "PAR" verschijnt. Druk op de toets "set" om te openen.	
Parameter "CF9" verschijnt. Gebruik de toetsen "down" en "up" om de parameter "bt 1" te selecteren.	
Druk op de toets "set" om te openen.	
Parameter "HA 1" verschijnt. Druk op de toets "set" om te openen.	
De standaardwaarde is "60.0" Gebruik de toetsen "down" en "up" om de waarde te wijzigen.	
Druk op de toets "set" om te bevestigen.	
De parameter is nu opgeslagen. Druk driemaal op de toets "esc" om af te sluiten.	

Dezelfde procedure voor sonde "bt2".

4.7 Weergave van sonde/ ventilator/ compressor

Koeler in bedrijf. Druk op de toets "up" om de sondes te bekijken <i>bt 1, bt 2, bt 3, bP 1.....</i>	
Selecteer de sonde en wacht enkele seconden. (Bijv. BT2)	
De waarde van sonde <i>bt 2</i> verschijnt.	
Aangeraden wordt om altijd terug te keren naar sonde <i>bt 1</i>	

Beschrijving:

bt 1 : temperatuursonde afvoerwater
bt 2 : temperatuursonde verdamper
bt 3 : voeler omgevingstemperatuur
bt 10 :temperatuursonde schakelkast (optie)
bP 1 : circuit 1 transmitter
bP 2 : circuit 2 transmitter; (van model ICEP080)

F_ _ _ : ventilatorwerking

F_ _ _ : ventilator UIT
F- _ _ : ventilator 1 AAN, ventilator 2,3 UIT: (2 = van model ICEP022) (3 = van model ICEP080)
F- - _ : ventilatoren 1 en 2 AAN, ventilator 3 UIT, (2 = van model ICEP022) (3 = van model ICEP080)
F- - - : ventilatoren 1,2 en 3 AAN (van model ICEP080)

[IC2 : compressoren werking:

[_ _ _ : compressoren uitgeschakeld
[- _ _ : compressoren UIT
[IC- : compressor 1 AAN, compressor 2 UIT
[IC2 : compressoren 1 en 2 AAN; (van model ICEP055)
[IC- : met "1" knipperende compressor klaar om te starten, compressor 2 UIT

4.8 Instelling klok/datum

<p>Schakel de koeler in "ON" met de hoofdschakelaar QS, en wacht op de weergave van de aanduiding "OFF".</p> <p>Druk tegelijkertijd op de toetsen "⏪" en "⏩" om het menu "Datum/tijd" te openen.</p>	
<p>Parameter "FrEE" verschijnt.</p> <p>Druk op de toets "set" om te openen.</p>	
<p>Parameter "A1" verschijnt.</p> <p>Gebruik de toetsen "⏪" en "⏩" om de parameter "CL" te selecteren.</p>	
<p>Druk op de toets "set" om te openen.</p>	
<p>Parameter "HOUr" verschijnt.</p> <p>Druk gedurende 5 seconden op de toets "set".</p> <p>De parameter wordt nu knipperend weergegeven.</p>	
<p>Gebruik de toetsen "⏪" en "⏩" om de datum, het uur of het jaar te selecteren voor de wijziging.</p>	
<p>Druk op de toets "set" om te openen.</p>	
<p>Gebruik de toetsen "⏪" en "⏩" om de waarde te wijzigen (bijv.: jaar)</p>	
<p>Druk op de toets "set" om te bevestigen.</p>	

Gebruik de toetsen "⏪" en "⏩" om nog een waarde te wijzigen (bijv.: datum)



Druk op de toets "esc" om af te sluiten.

De parameter stopt met knipperen.











Druk tegelijkertijd op de toetsen "⏪" en "⏩" om af te sluiten.



⚠ Het geheugen van de "klok/datum" heeft een maximale duur van drie dagen. Dus, als de controller langer dan drie dagen niet wordt gevoed, gaat de instelling van voor uur / maand / jaar verloren. Stel de klok in bij het starten van de machine, en wanneer dat nodig is.





4.9 Alarmbeheer

<p>Wanneer er sprake is van een alarm, worden linksboven een alarmcode en een symbool weergegeven</p> <p> Continu = alarm aanwezig Knipperend = waarschuwing aanwezig / alarm kan gereset worden</p>	
<p>Druk op de toets "set" om te openen.</p>	
<p>Parameter "ALH," verschijnt.</p> <p>Druk op de toets "↵" om de parameter "AL" te selecteren.</p>	
<p>Druk op de toets "set" om te openen.</p>	
<p>De alarmcode verschijnt, bijv.: "Er04".</p> <p>Druk op de toets "↵" om te controleren of er meer alarmen aanwezig zijn.</p>	
<p>Verhelp de storingen alvorens de reset uit te voeren.</p> <p>Nadat de storing is verholpen, gaat het alarmsymbool knipperen. Nu kunt u de reset uitvoeren.</p>	
<p>Druk op de toets "esc", tot het alarm verdwijnt.</p>	

Lijst alarmen/waarschuwingen

Code	Beschrijving	Actie	Reset
Er01	Sensor bt1 losgekoppeld of defect	Alarm	M
Er02	Sensor bt2 losgekoppeld of defect	Alarm	M
Er03	Sensor bt3 losgekoppeld of defect	Alarm	A
Er05	Sensor bt10 losgekoppeld of defect	Alarm	A
Er06	Sensor bP1 losgekoppeld of defect	Alarm	M
Er08	Hogedrukschakelaar circuit 1	Alarm	M
Er09	Lagedrukschakelaar circuit 1	Alarm	M
Er12	Hoge temperatuur bt1	Alarm	M
Er13	Lage temperatuur bt1	Alarm	A
Er14	Hoge temperatuur bt2	Alarm	M
Er15	Lage temperatuur bt2	Alarm	M
Er16	Hoge temperatuur bt3	Alarm	A
Er17	Lage temperatuur bt3	Alarm	A
Er18	Thermische beveiliging compressor 1	Alarm	M
Er20	Thermische beveiliging pomp 1	Alarm	M
Er22	Laag waterniveau / Drukverschilschakelaar	Alarm	M
Er23	Bewaking fase	Alarm	M
Er24	Uitbreiding defect of losgekoppeld	Alarm	M
Er25	Bedrijfsuren compressor 1 overschreden	Waarschuwing	M
Er27	Bedrijfsuren eenheid overschreden	Waarschuwing	M
Er28	Geheugen klok	Waarschuwing	A
Er29	Configuratie koeler	Waarschuwing	A





4.10 Alarmgeschiedenis

<p>Koeler in bedrijf. Druk op de toets "set" om de alarmgeschiedenis te bekijken.</p>	
<p>Druk op de toets "set" om te openen.</p>	
<p>Gebruik de toetsen "⏮" en "⏭" om de parameters te bekijken. (Par. 4.5.5)</p>	
<p>Druk op de toets "set" om de waarde te bekijken.</p>	

5 Onderhoud

- De machine is ontworpen en gebouwd om constant te kunnen functioneren; de levensduur van zijn componenten is echter afhankelijk van het uitgevoerde onderhoud.
-  Geef bij de aanvraag van assistentie of vervangingsonderdelen de machine model en serienummer van de door het typeplaatje aan de buitenkant van de eenheid te lezen. (www.polewr.com)

5.1 Algemene waarschuwingen

-  Alvorens onderhoud te plegen moet worden nagegaan of de koeler is afgekoppeld van de voeding.
-  Gebruik altijd originele vervangingsonderdelen van de fabrikant: anders is de fabrikant niet aansprakelijk in geval van storingen aan de machine.
-  Wendt u ingeval van het lekken van het koelmiddel tot ervaren en erkend personeel.
-  De Schrader klep mag uitsluitend gebruikt worden wanneer de machine niet naar behoren functioneert: indien de klep toch wordt gebruikt zal de schade, die door het verkeerd laden van het koelmiddel wordt veroorzaakt, niet door de garantie worden gedekt.

5.2 Koelvloeistof













Vullen van machine: eventuele schade, die het gevolg is van het op verkeerde wijze vullen van de machine door niet erkend personeel, zal niet door de garantie worden gedekt. 

-  Het apparaat bevat gefluoreerde broeikasgassen. De koelvloeistof R513A is bij een normale temperatuur en normale druk een kleurloos gas en behoort tot de SAFETY GROUP A1 - EN378 (vloeistof groep 2 tweede richtlijn PED 2014/68/EU); GWP (Global Warming Potential) = 629.

-  Bij lekken van koelvloeistof de ruimte luchten.

5.3 Preventief onderhoudsprogramma

Om een blijvende, maximale efficiëntie en betrouwbaarheid van de chiller te garanderen moet het volgende worden gedaan:

Beschrijving onderhoudswerkzaamheid	Onderhoudsinterval (onder standaard werkingsomstandigheden)				
	Werkzaamheid controlleren  Service 	Dagelijks	Om de 6 maanden	Om de 12 maanden	Om de 36 maanden
Controleren of het lampje POWER ON brandt.					
De lampjes van het controlepaneel controleren.					
De vinnen van de condensor reinigen					
De stroomopname controleren.					
Controleer de koelmiddellekken.					
De Veiligheidsklep controleren en reinigen water(indien aanwezig)*					
Elektrische systeem en de schakelkast controleren.**					
Controleer temperatuursondes. Vervang indien nodig.				 	
Onderhoudsset.					

 Beschikbaar zijn (zie paragraaf 7.):

- servicekit: elektrischekit; compressorkit; ventilatorkit; verdamperkit; pompkit; watertankkit;
- Losse vervangingsonderdelen.

*Om volledige efficiëntie te garanderen, moeten de veiligheidskleppen regelmatig gecontroleerd worden.

Na verloop van tijd kunnen zich in de nabijheid van de plug onzuiverheden afzetten; derhalve is een periodiek spoeling van de zitting noodzakelijk. Voor deze spoeling moet de klep handmatig worden afgetapt door de knop in de richting van de pijlen te draaien.

Belangrijk: Zorg ervoor dat na deze handeling de bedrijfsdruk wordt hersteld.

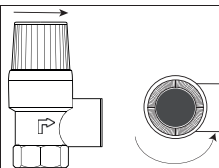



** Tijdens het periodieke onderhoud moeten het elektrische systeem van de machine en de schakelkast ook gecontroleerd worden, in overeenstemming met de plaatselijke regelgeving. Verder moet er altijd, wanneer dat mogelijk is, een visuele inspectie van de apparatuur en de elektrische geleiders worden uitgevoerd en moet ook gecontroleerd worden of de aanscherping van de aansluitklemmen van de voedingscomponenten overeenkomt met de aanhaalmomenten aangegeven op het elektrische schema.

5.4 Afdanken

De koelvloeistof en de smeerolie in het circuit moeten worden verwerkt overeenkomstig de plaatselijke geldende milieuvoorschriften.

De koelvloeistof wordt teruggewonnen voordat het apparaat definitief wordt vernietigd ((EU) Nr 517/2014 art.8).

 RECYCLING VERWERKING 	
structuur	staal/epoxyharsen, polyester
reservoir	aluminium/koper/staal
leidingen/collectoren	koper/aluminium/koolstofstaal
isolatie leidingen	nitrilrubber (NBR)
compressor	staal/koper/aluminium/olie
Condensador	staal/koper/aluminium
pomp	staal/gietijzer/messing
ventilator	aluminium
koelmiddel	R513A
kleppen	messing/koper
elektriciteitskabels	koper/PVC

Apparatuur die elektrische componenten bevat, moet apart worden ingezameld met elektrisch en elektronisch afval in overeenstemming met de lokale en huidige wetgeving.



6 Opsporen van storingen

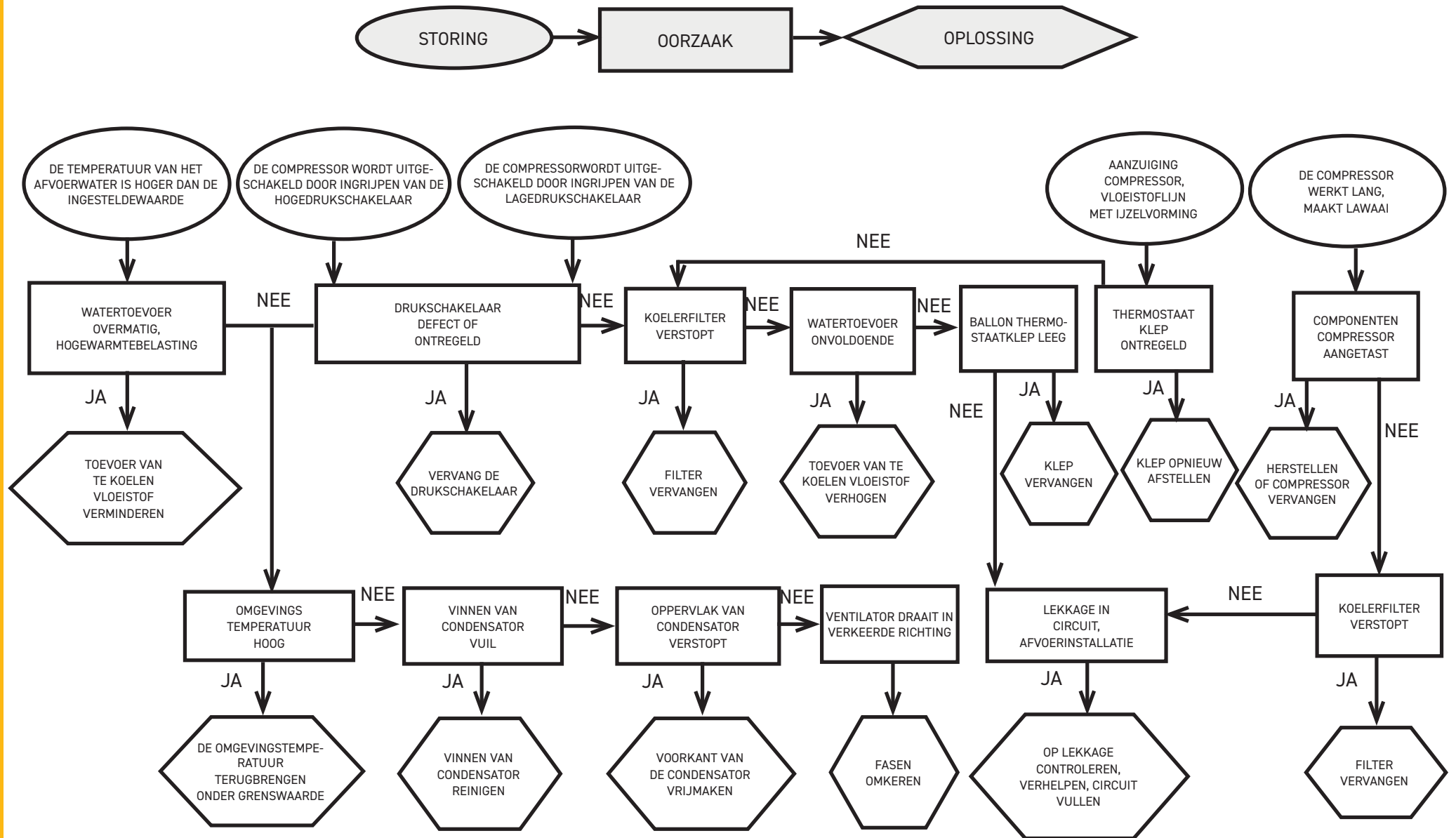

1 Sikkerhed	2
1.1 Instruktionsbogens vigtighed.....	2
1.2 Advarselssignaler	2
1.3 Sikkerhedsforskrifter	2
1.4 Resterende risici.....	2
2 Indledning	3
2.1 Transport	3
2.2 Flytning.....	3
2.3 Inspektion.....	3
2.4 Oplagring	3
3 Installation	3
3.1 Arbejdsrum.....	3
3.2 Versioner.....	3
3.3 Vandkredsløb.....	3
3.3.1 Kontroller og tilslutning.....	3
3.3.2 Vand og etylenglykol.....	4
3.3.3 Ekspansionsbeholder	4
3.4 Elektrisk kredsløb.....	5
3.4.1 Kontroller og tilslutning.....	5
3.4.2 Generelle alarmer.....	5
3.4.3 ON/OFF via fjernbetjening	5
3.5 Version med vand (W).....	5
4 Betjening	6
4.1 Kontrolpanel	6
4.2 Symbolernes betydning	6
4.3 Start køleren.....	6
4.3.1 Justeringer ved ibrugtagning.....	6
4.3.2 Starter med vand med høj temperatur.....	6
4.4 Slukning af køleren.....	7
4.5 Parameterindstillinger.....	7
4.5.1 Kølerparametre (CF9).....	7
4.5.2 Temperaturstyring (CNP).....	7
4.5.3 Vedligeholdelsesparametre (PnE).....	7
4.5.4 Sondeparametre (bE 1, bE2).....	7
4.5.5 Alarmhistorik (ALH i).....	7
4.6 Skift parametre (User)	8
4.6.1 Kølerparametre "CF9".....	8
4.6.2 Temperaturstyring "CNP".....	13
4.6.3 Sondeparameter "bE 1".....	14
4.7 Visualisering af sonde/ ventilator/ Kompressor.....	14
4.8 Indstilling af ur/ dato.....	15
4.9 Alarmstyring.....	16
4.10 Alarmhistorik.....	17
5 Vedligeholdelse	17
5.1 Generelle advarsler.....	17
5.2 Kølevæske	17
5.3 Program preventivní údržby.....	18
5.4 Demontering	18





7 Tillæg
7.1 Tegnforklaring
7.2 Installationsdiagram
7.3 Flytning - Arbejdsrum
7.4 Tekniske data
7.5 Mål
7.6 Reservedelstliste
7.7 Eksplosionstegninger
7.8 Kredsløbsdiagram
7.9 Eldiagram

1 Sikkerhed

1.1 Instruktionsbogens vigtighed

- Opbevar den i hele maskinens levetid.
- Læs den før alle indgreb.
- Den kan ændres: for ajourførte informationer, se i bogen i maskinen.

1.2 Advarselssignaler

	Instruktioner for at undgå farer for personer.
	Instruktion, der skal følges for at undgå skader på apparatet.
	Det kræves, at en kompetent og autoriseret tekniker er til stede.
	Der er symboler, hvis betydning er beskrevet i afsnittet 7.

1.3 Sikkerhedsforskrifter

 Hver enhed er forsynet med en elektrisk afbryder til at gribe ind for at bevare sikkerheden. Brug altid denne anordning til at fjerne farer under vedligeholdelsen.

 Instruktionsbogen er kun beregnet til slutbrugeren til operationer, der kan udføres med lukkede paneler: operationer Installation/ ibrugtagning/ Vedligeholdelse , der kræver åbning med værktøj, skal udføres af kvalificerede fagfolk.

 Kun til installation på steder, der ikke er tilgængelige for offentligheden, enten på et sikret sted med begrænset adgang eller i en højde af mindst 2,5 m eller i sikrede tagområder, medmindre de er under opsyn eller har fået instruktion i brugen af apparatet af en person, der er ansvarlig for deres sikkerhed.



 Installationsafstanden fra væggen og den frie driftsplads er angivet i afsnit 7.3.

 Advarsel: Overhold min./maks. temperatur og tryk angivet i afsnit 7.4, og det samlede driftstemperaturområde angivet i afsnit 7.2.

 Alle enhederne kunne installeres udendørs.

 Alle elektriske tilslutninger skal overholde gældende regulativer i det land, hvor maskinen skal installeres.

 Overskrid aldrig de projekterede begrænsninger som angivet på typepladen.

  Det er brugerens ansvar at undgå belastninger, der er anderledes end det indre statiske tryk. Hvis der er risiko for seismisk aktivitet, skal enheden være passende beskyttet. Anvend udelukkende enheden til professionel brug og til det formål, hvortil den er beregnet.

 Det er brugerens opgave at evaluere alle aspekter ved produktets anvendelse og installation, at efterleve alle relevante industristandarder mht. sikkerheden samt at følge alle forskrifter vedrørende produktet, som er beskrevet i brugsvejledningen og i den supplerende dokumentation leveret med enheden.

Ulovlig ændring eller udskiftning af en hvilken som helst komponent, der udføres af uautoriseret personale og/eller ukorrekt brug af enheden, vil friholde producenten for ethvert ansvar og medføre bortfald af garantien.

Producenten frasiger sig ethvert ansvar nu og i fremtiden for skader på personer, ting og selve maskinen som følge af operatørernes forsømmelighed, manglende overholdelse af alle instruktioner anført i denne instruktionsbog og manglende overholdelse af de gældende regler for anlæggets sikkerhed. Producenten påtager sig intet ansvar for eventuelle skader på grund af ændringer og/eller forandringer af emballagen.

Det er brugerens ansvar at sikre sig, at de angivne specifikationer til brug for valget af enheden og dens komponenter og/eller det valgfri ekstraudstyr er udtømmende for en korrekt eller rimelig forventelig brug af selve enheden eller dens komponente

 **IEMÆRK: Producenten forbeholder sig retten til at foretage ændringer i denne vejledning uden forudgående varsel. Brugeren opfordres til at konsultere vejledningen på maskinen for at få de mest fyldestgørende og opdaterede oplysninger.**

1.4 Resterende risici

Installation, opstart, standsning og vedligeholdelse af maskinen skal udføres nøjagtigt i henhold til instruktionerne i den tekniske dokumentation, der følger med maskinen, og således at der ikke opstår farlige situationer.

De risici, der ikke har været muligt at eliminere på konstruktionsstadiet, fremgår af følgende tabel..

del	resterende risiko	opstår ved	forholdsregler
varmevekslerspiralen	små snitsår	kontakt	undgå kontakt, bær beskyttelseshandsker
blæser og blæserrist	læsioner	indførelse af spidse genstande gennem risten, medens blæserristen er i funktion	undlad at stikke nogen form for genstande ind igennem blæserristen og stil ikke noget oven på risten
indvendig i enheden: kompressor og udløbsrør	forbrændinger	kontakt	undgå kontakt, bær beskyttelseshandsker

del	resterende risiko	opstår ved	forholdsregler
indvendig i enheden: metaldele og elektriske ledninger	forgiftninger, elektriske stød, alvorlige forbrændinger	defekter i strømforsyningskablet før enhedens elektriske panel, strømførende metaldele	tilstrækkelig elektrisk beskyttelse af strømforsyningsledningen; sørg for, at alle metaldele er jordet omhyggeligt
uden for enheden: området rundt om enheden	forgiftninger, alvorlige forbrændinger	brand som følge af kortslutning eller overophedning af forsyningsledningen før enhedens elektriske panel	sørg for, at kablernes tværsnit og forsyningsledningens beskyttelsessystem overholder gældende regler

2 Indledning

Kompressorens, pumpens og ventilatorens motorer er udstyret med termosikring, der beskytter mod overophedning.

2.1 Transport

Den emballerede enhed skal forblive:

- I lodret position.
- Beskyttet mod atmosfæriske kræfter.
- Beskyttet mod stød.

2.2 Flytning

Brug gaffeltruck, der er egnet til vægten, der skal løftes, og undgå enhver form for stød.

2.3 Inspektion

- På fabrikken samles alle enheder, forsynes med ledninger, påfyldes kølevæske og olie og afprøves.
- kontrollér maskinens stand efter modtagelsen: klag straks til transportfirmaet over eventuelle skader.
- udpak enheden så tæt som muligt ved installationsstedet.

2.4 Oplagring

- Opbevar den emballerede enhed på et rent sted, der er beskyttet mod fugtighed og dårligt vejr.
- Anbring ikke enhederne oven på hinanden.
- Følg anvisningerne på emballagen.

3 Installation

 Den optimale installation opnås ved at overholde anvisningerne i afsnittene 7.

 Det installerede produkt skal være passende beskyttet mod brandrisiko (ref. EN378-3).

 **Det anbefales at udstyre alle kølere med et passende forfilter i nærheden af kølerens vandindgang (grade af filterrin: min.05mm; max 1.0mm).**

 **Væsker, der skal nedkøles**

De væsker, der skal nedkøles, skal være kompatible med de anvendte materialer.

Eksempler på anvendte væsker er **vand eller blandinger af vand og ætylen- eller propilenglykol.**

De væsker, der skal nedkøles, må ikke være brændbare.

Hvis væskekerne, der skal afkøles, indeholder farlige stoffer (som for eksempel ætylen/propylenglykol), skal den eventuelle væske, der er løbet ud fra et tæt område, opsamles fordi den er farlig for miljøet. I tilfælde af tømning af det hydrauliske kredsløb skal man følge de gældende regler og ikke sprede indholdet i miljøet.

3.1 Arbejdsrum

 Lad der være en plads på 1,5 meter rundt om enheden.

Der skal være mindst 2 meters fri plads over køleanlægget for de modeller, der har en lodret udstødning af kondensatorluften.

3.2 Versioner

Version med luft - Aksialventilatorer (A)

Skab ikke situationer med recirkulering af afkølingsluften.

Spær ikke ventilationsristene.

Til versioner med aksiale ventilatorer frarådes det at kanalisere udtømningsluften.

Version med vand (W)

Hvis kondensatorvandet løber i et lukket kredsløb, installeres et netfilter på kondensatorvandets indløb.

For specielt kølevand (afioniseret, afmineraliseret, destilleret) kan det forekomme, at standardmaterialerne beregnet til kondensatoren, ikke er egnede. I så fald bedes man kontakte producenten.

3.3 Vandkredsløb

3.3.1 Kontroller og tilslutning

 Inden køleanlægget tilsluttes og vandkredsløbet fyldes, skal det kontrolleres, at rørene er rene. Hvis det ikke er tilfældet skylles de grundigt.

  **Hvis det hydrauliske kredsløb er lukket, en sikkerhedsventil indstillet til: 6 bar.**

 Det anbefales altid at installere meshfiltre på vandets ind- og udløbsrør.

 Hvis hydraulikkredsløbet afbrydes af automatiske ventiler, skal pumpen beskyttes med systemer mod vandslag.

 Hvis kredsløbet skal tømmes i forbindelse med længerevarende stilstand, anbefales det at

tilsætte smørevæske til pumpens svinghjul for at undgå blokeringer ved den efterfølgende igangsætelse. I tilfælde af blokering af svinghjulet gøres følgende til manuel frigørelse.

Fjern pumpens bagerste dæksel, og drej forsigtigt på plasticvingen. Hvis akslen stadig er blokeret, skal man fjerne vingen og forsøge at dreje direkte på akslen. Når svinghjulet er frigjort, monteres vingen og dækslet igen.

Indledende kontroller

1. Kontroller, at de eventuelle stophaner i vandkredsløbet er åbne.
2. Hvis vandkredsløbet er af den lukkede type, kontrolleres det, om der er installeret en ekspansionsbeholder med passende kapacitet.

Tilslutning

1. Forbind vandkøleanlægget til ud- og indgangsrørene ved hjælp af forbindelserne på bagsiden af enheden.
Det tilrådes at benytte bøjelige tilslutninger for at reducere systemet stivhed.
2. Fyld vandkredsløbet ved hjælp af den dertil beregnede påfyldningstilslutning bag på () køleanlægget .
3. Tanken er udstyret med en ådeventil, der skal betjenes manuelt under fyldningen. Til det formål skal man, hvis hydraulikkredsløbet har nogle punkter ved større højde, installere en afluftningsventil i disse punkter.
4. Det tilrådes at udstyre indgangs- og udgangsrørene med en hane, så maskinen kan isoleres fra kredsløbet under vedligeholdelse.
5. Hvis køleren arbejder med åbent kar, skal pumpen installeres i karrets sugeside og i kølerens trykside.



Advarsel (modeller 022-120): maskinen er udstyret med en automatisk beskyttelsesanordning til tanken.

Hvis vandindløbet utilsigtet lukkes, når pumpen kører, og vandudløbet er åbent, kommer luft ind i tanken med sandsynligvis indgreb fra niveausensoren. Det vil være nødvendigt at udlufte det hydrauliske kredsløb for at eliminere luften.

Efterfølgende kontroller

1. Kontroller, at tanken og vandkredsløbet er helt fyldt med vand, og at der ikke er luft i systemet.
2. Hydraulikkredsløbet skal fyldes op. Af den grund skal der foretages regelmæssige kontroller, og kredsløbet skal om nødvendigt fyldes efter, eller der skal monteres en automatisk påfyldningsanordning.

Specifikationer for vandet

Hvis ikke det medfølger, installeres netfilter på indgangen til kondenseringsvandet.



Specifikationer for vandet:

Temperatur	≥50°F (10°C)	CL ⁻	<50 ppm
ΔT IN/OUT	5-15°C	CaCO ₃	70-150 ppm
Max % glycol	50	O ₂	<0.1 ppm
Tryk	43.5-145 PSiG (3-10 barg)	Fe	<0.2 ppm
PH	7.5-9	NO ₃	<2 ppm
Elektrisk ledesevne	10-500 μS/cm	HCO ₃ ⁻	70-300 ppm
Mætningsindeks for Langelier	0-1	H ₂ S	<0.05 ppm
SO ₄ ²⁻	<50 ppm	CO ₂	<5 ppm

NH ₃	<1 ppm	Al	<0.2 ppm
-----------------	--------	----	----------

For specielt vand (afoniseret, afmineraliseret, destilleret) kan det forekomme, at standardmaterialerne beregnet til køleanlægget, ikke er egnede. I så fald bedes man kontakte producenten.

3.3.2 Vand og etylenglykol

Hvis køleanlægget monteres udenørs eller i et uopvarmet område, kan vandet i kredsløbet fryse, hvis anlægget ikke kører i den koldeste tid på året.

For at reducere denne fare:

- forsyne køleanlægget med den passende antifrostbeskyttelse, som producenten leverer som ekstraudstyr;
- tømme systemet gennem afløbsventilen, hvis køleanlægget ikke skal køre i en længere periode;
- tilsætte den korrekte mængde frostvæske til vandet i kredsløbet (se tabellen).

Vandets udløbstemperatur [°C]	Etylenglykol (% vol.)	Rumtemperatur
4	5	-2
2	10	-5
0	15	-7
-2	20	-10
-4	25	-12
-6	30	-15
-10	40	-20

3.3.3 Ekspansionsbeholder

For at undgå, at væskens volumen øges eller reduceres på grund af ændringer i dens temperatur, hvilket kan medføre skader på maskinen eller vandkredsløbet, anbefaler vi, at De monterer en ekspansionsbeholder af passende størrelse.

Ekspansionskarret installeres til udsugning på den pumpen, der er tilsluttet bag tanken.

Man kan udregne minimumvolumen for en ekspansionsbeholder, der skal monteres i et lukket kredsløb, på følgende måde:

$$V=2 \times V_{tot} \times (P_{t \text{ min}} - P_{t \text{ maks}})$$

hvor

V_{tot}= den totale volumen i kredsløbet (i liter)

P t min./maks. = den vægt, der kan opnås af vandet ved henholdsvis minimum- og maksimumtemperatur [kg/dm³].

Værdierne for vægten ved forskellige temperaturer og forskelligt glykolindhold fremgår af nedenstående tabel.

% glycol	Temperatur [°C]						
	-10	0	10	20	30	40	50
0%	1.0024	1.0008	0.9988	0.9964	0.9936	0.9905	0.9869
10%	1.0177	1.0155	1.0130	1.0101	1.0067	1.0030	0.9989
20%	1.0330	1.0303	1.0272	1.0237	1.0199	1.0156	1.0110
30%	1.0483	1.0450	1.0414	1.0374	1.0330	1.0282	1.0230
40%	1.0636	1.0594	1.0525	1.0511	1.0461	1.0408	1.0350



Pas på: I påfyldningsfasen skal man også referere til data for påfyldning i ekspansionsbeholderen.

Hvis den omgivende lufttemperatur ved køleren er mindre end -10°C, skal du flytte ekspansionsbeholderen til en beskyttet omgivelsestemperatur tæt på vandretursiden af køleren.

Sikkerhedsventilen og udluftningsventilen skal forblive ved køleren.

3.4 Elektrisk kredsløb

3.4.1 Kontroller og tilslutning

 Inden der udføres noget arbejde på det elektriske system, skal man sikre sig, at maskinen er afbrudt fra strømforsyningen.

Alle elektriske tilslutninger skal overholde gældende regulativer i det land, hvor maskinen skal installeres.

Indledende kontroller

1. Nettets spænding og frekvens skal svare til de værdier, der er anført på køleanlæggets typeskilt. Forsyningsspændingen må aldrig, heller ikke i korte perioder, være uden for de grænser, der er angivet i det elektriske diagram, hvilket, medmindre andet er angivet, vil sige +/- 10 % for spændingen og +/- 1 % for frekvensen.
2. Spændingen skal være symmetrisk (de effektive værdier for spænding og fasevinkler mellem efterfølgende faser skal være ens). Den maksimale ubalance som er tilladt mellem spændingerne er lig med 2%.

Tilslutning

1. Den elektriske forsyning af køleanlæggene skal ske med et kabel med 4 tråde, 3 poler + jord, uden nul. For kablets minimumssnit, se afsnit 7.
2. Træk kablet gennem kabelindgangen i maskinens bagpanel, og forbind fasen og nulledningen til isolatorkontaktens terminaler (QS). Forbind jordledningen til jordterminalen (PE).
3. 3) Kontroller, at forsyningskablet ved udgangspunktet har en beskyttelse imod direkte kontakt på mindst IP2X eller IPXXB.
4. På den elektriske forsyningslinje til køleanlægget installeres et fejlstrømsrelæ med en udløsningsfølsomhed på (RCCB - IDn = 0.3A) med den maksimale strømforsyning, der er angivet på strømdiagrammet, og med en brydeevne svarende til kortslutningsstrømmen i maskinens installationsområde.
Den nominelle inputstrøm i denne termosikring skal være lig med FLA, og aktiveringskurven skal være type D.
5. Maks. værdi for netmodstand = 0,274 ohm.

Efterfølgende kontroller

Kontroller, at maskinen og ekstraudstyret er jordforbundet og beskyttet mod kortslutning og/eller overbelastning.

 Når enheden er blevet tilsluttet, og hovedafbryderen er lukket (så strømmen er sluttet til maskinen), vil spændingen i det elektriske kredsløb nå et farligt niveau. Der bør udvises stor forsigtighed!

 Det er installatørens ansvar at udføre de obligatoriske minimumstest for at sikre korrekt elektrisk installation i overensstemmelse med lokale regler og i koordinering med det relevante jordingssystem, inklusive specifikke krav til isolerede neutral-systemer (IT).

3.4.2 Generelle alarmer

Alle køleanlæggene er udstyret med en maskinalarm (se eldiagrammet), bestående af en spændingsfri skiftekontakt forbundet med klemkassen: herved gøres det muligt at slutte en centraliseret udvendig alarm, akustisk, visuel eller tilsluttet logiske enheder som f.eks. en PLC.

3.4.3 ON/OFF via fjernbetjening

Samtlige køleanlæg kan tilsluttes en fjernbetjening (afsnit 7.).

- For at aktivere fjernbetjeningen rif. n.16387

- Som referencevariabel ON/OFF rif.n.8996

Bemærk: Aktiver ikke "Sup" og "Re" sammen.

Se eldiagrammet vedrørende tilslutning af afbryderkontakten (afsnit 7.).

3.5 Version med vand (W)

I Kølere med vandkondensering har brug for et hydraulisk kredsløb, der fører friskt vand til kondensatoren.

Chilleren er i versionen med vand, udstyret med en pressostatventil ved indgangen til kondensatoren, hvis funktion er at regulere vandkapaciteten, således at der hele tiden opnås en optimal kondensering.

Indledende eftersyn

Hvis vandet, der forsyner kondensatoren, kommer fra et lukket kredsløb, udføres først de kontroller, der er opført på listen for det hydrauliske hovedkredsløb (afsnit 3.3.1).

Tilslutning

1. Det anbefales, at udstyre kondensatorens vandkredsløb med en stopventil, så maskinen kan isoleres i tilfælde af vedligeholdelse.
2. Forbind rørene til vandindgang/---afløb til de tilsvarende tilslutninger bag på enheden.
3. Hvis vandet til kondensatoren ikke kommer fra et lukket kredsløb, anbefales det at udstyre kredsløbet med et indgangsfilter for at mindske forurening af overfladerne.
4. Hvis vandet kommer fra et lukket kredsløb, kontrolleres det, at der er fyldt tilstrækkeligt vand på, og at kredsløbet er udluftet.

4 Betjening

4.1 Kontrolpanel



OP-knap: tryk for at øge værdien af et valgt redigerbart parameter.



NED-knap: tryk for at mindske værdien af et valgt redigerbart parameter.



ESC-knap: for at afslutte uden at gemme. Går tilbage til forrige niveau.

HOLDES INDE I 5s. NULSTILLING AF ALARM.



SET-knap: for at forlade og gemme/bekræfte værdien, gå til næste niveau, gå ind i Set-menuen; **HOLDES INDE I 5s. START KØLER.**

4.2 Symbolernes betydning

Symbol	Symbolstatus	Funktion	Symbol	Symbolstatus	Funktion
	Lyser	Kompressor ON		Lyser	Temperaturværdi
	Blinker	Kompressor standby			
	Off	Kompressor OFF			
	Lyser	Alarm		Lyser	Trykværdi
	Blinker	Advarsel eller Alarm kan nulstilles			
	Off	Ingen alarm			
	Lyser	Pumpe 1 ON		Lyser	Frostvæskevarmer ON
	Off	Pumpe 1 Off		Off	Frostvæskevarmer Off
	Lyser	Pumpe 2 ON (forefindes ikke)		Lyser	Krumtaphusvarmer ON Kompressor 1
	Off	Pumpe 2 Off (forefindes ikke)		Off	Krumtaphusvarmer Off Kompressor 1
	Lyser	Pumpe 2 ON (forefindes ikke)		Lyser	Krumtaphusvarmer ON Kompressor 2 (forefindes ikke)
	Off	Pumpe 2 Off (forefindes ikke)		Off	Krumtaphusvarmer Off Kompressor 2 (forefindes ikke)

4.3 Start køleren

1. Slut strøm til apparatet ved at dreje hovedafbryderen QS TIL.
2. Tryk på knappen "set" for at starte.
3. Indstil den ønskede temperatur på styreenheden. (par. 4.5.1)

Fasemonitor

Hvis der ved start vises "Er23" i alarmdisplayet, skal brugeren kontrollere, at kablerne er monteret rigtigt på klemmskrueerne på indgangssiden ledningsadskillelseskontakt.

4.3.1 Justeringer ved ibrugtagning

1. Temperaturindstilling. Se afsnit 4.5 vedrørende ændring af indstillingen.
2. Regulering af Pumpe

Kontroller at pumpen virker korrekt ved hjælp af en trykmåler (aflæs P1 og P0), og kontroller trykgrænseværdierne (Pmax og Pmin), der er angivet på pumpens mærkeplade.

P1 = tryk med pumpen TIL

P0 = tryk med pumpen FRA

$P_{min} < (P1 - P0) < P_{max}$

- Eksempel nr. 1.

Driftsbetingelser:

lukket kredsløb, tryk P0 = 2 bar

pumpens mærkepladeværdier: Pmin 1 bar/ Pmax 3 bar

juster ventiludgangen til at give et tryk på 3 bar < P1 < 5 bar

- Eksempel nr. 2.

Driftsbetingelser:

Åbent kredsløb, tryk P0 = 0 bar

pumpens mærkepladeværdier: Pmin 1 bar/ Pmax 3 bar

juster ventiludgangen til at give et tryk på 1 bar < P1 < 3 bar

3. Kontroller, at pumpen virker korrekt på samme måde som under normale driftsforhold. Kontroller også, at pumpens strømstyrke er inden for de grænser, der er angivet på mærkepladen.
4. Sluk for køleren, og fortsæt med at fylde det hydrauliske kredsløb op ved "SET"-temperaturen.
5. Kontroller, at temperaturen i det "behandlede" vand ikke kommer under 5 °C, og at omgivelsestemperaturen, ved hvilken det hydrauliske kredsløb virker, ikke falder under 5 °C. Hvis temperaturen er for lav, tilføjes en passende mængde glykol, som forklaret i afsnit 3.3.3



OBS! Luk for vandudløbsventilen (skal monteres af kunden), inden der tændes for kølepumpen.

Hold altid vandindløbsventilen (skal monteres af kunden) åben.

Åbn langsomt for kølerens vandudløbsventil, når der tændes for pumpen, og juster flowhastigheden som beskrevet i punkt 4.3.1.

4.3.2 Starter med vand med høj temperatur

Hvis vandtemperaturkredsløbet er højt (f.eks. 30-35 °C), skal afspærringsventilen (installeret af kunden) ved kølerens udløb gradvist lukkes (men ikke helt, ca. to tredjedele!) for at reducere vandgennemstrømningen gennem enheden. Åbn ventilen gradvist, så snart vandtemperaturen falder til driftsværdien.

Vigtigt: I denne situation kan der forekomme flere højtryksalarmer, som skal nulstilles manuelt.

Vigtigt: Denne justering giver dig også mulighed for at undgå vandslag langs rørene på grund af luftlommer i kredsløbet (luftlommer skal elimineres via udluftningsventiler på de højeste punkter i det hydrauliske kredsløb installeret af kunden).

4.4 Slukning af køleren

Når køleren ikke længere er nødvendig, slukkes der for den således: Tryk på knappen "set" (5 sec.). Sluk ikke på QS-hovedafbryderen for at sikre, at der stadig er strøm til frostbeskyttelsesenhederne.

4.5 Parameterindstillinger

Generelt

Der findes to niveauer for parameterbeskyttelse:

- Direkte User-(U): med øjeblikkelig adgang, **kan ændres af brugeren**.
- Adgangskodebeskyttet Service(S): adgang kræver adgangskode, **(må ikke ændres)**.

4.5.1 Kølerparametre (CFG)

PARAMETER	KODE	TYPE	STANDARD
Måleenhed.	R1	U	OFF
Alarmrelæstyring	CFJ1	U	0
Gendan standardparametre	dEF	U	OFF
Fjernbetjeningsmodus til/fra	R7	U	0
Softwareversion	UEr	U	1.70
Enhedsadresse	CF30	U	1
Baudrate	CF31	U	5
Modbus-protokol	CF32	U	1
Aktivering overvågning til/fra	SUP	U	OFF
Dynamisk indstillingspunkt aktivering	Erd	U	OFF

4.5.2 Temperaturstyring (ENP)

PARAMETER	KODE	TYPE	STANDARD
Temperaturstyring indstillingspunkt (standard)	SEt	U	13.0
Temperaturstyring indstillingspunkt (præcisionsstyring)	SEt	U	20.0
Temperaturstyring differentiale (IKKE til stede i konfigurationen "præcisionsstyring")	dIF1	U	4.0

4.5.3 Vedligeholdelsesparametre (Mnt)

PARAMETER	KODE	TYPE	STANDARD
Enhedens arbejdstimer	UH	U	-
Enhedens arbejdstimer (X1000)	UHL	U	-
Enhedens delvise arbejdstimer	UPH	U	-
Enhedens delvise arbejdstimer (X1000)	UPHL	U	-
Kompressorens arbejdstimer 1	CIH	U	-
Kompressorens arbejdstimer 1 (X1000)	CIHL	U	-

4.5.4 Sondeparametre (bt 1, bt2)

Sonde (bt 1)

PARAMETER	KODE	TYPE	STANDARD
Alarm for høj temperatur (vand)	HR1	U	60

Sonde (bt2)

PARAMETER	KODE	TYPE	STANDARD
Alarm for høj temperatur (vand)	HR2	U	60

4.5.5 Alarmhistorik (ALH 1)

PARAMETER	KODE	TYPE	STANDARD
Alarmnummer	HYS1	U	-
Se alarmkode	HYS2	U	-
Se dag og måned for alarmerne	HYS3	U	-
Se time og minutter for alarmerne	HYS4	U	-
bt1 temperatur på tidspunktet for alarmerne	HYS5	U	-
bt2 temperatur på tidspunktet for alarmerne	HYS6	U	-
SET forholdene på tidspunktet for alarmerne	HYS7	U	-

4.6 Skift parametre (User)

4.6.1 Kølerparametre "CF9"

Måleenhed.

Tænd for køleren "ON" på hovedafbryderen QS, og vent, til displayet viser "OFF". Tryk samtidigt på knapperne "esc" og "set" for at gå ind i parametertype "U".	
Parameteret "PAR" vises. Tryk på knappen "set" for at gå ind.	
Parameteret "CF9" vises. Tryk på knappen "set" for at gå ind.	
Parameter "A I" vises. Tryk på knappen "set" for at gå ind	
Standardværdien er "OFF" = °C Brug knapperne "∇" og "∧" til at vælge måleenhed. OFF : temperatur = °C, Celsius ; tryk = Bar; ON : temperatur = °F, Fahrenheit; tryk =PSI	
Tryk på knappen "set" for at bekræfte.	
Returner automatisk til "A I" Parameteret er nu gemt. Tryk tre gange på knappen "esc" for at afslutte.	

Alarmstyring

Tænd for køleren "ON" på hovedafbryderen QS, og vent, til displayet viser "OFF". Tryk samtidigt på knapperne "esc" og "set" for at gå ind i parametertype "U".	
Parameteret "PAR" vises. Tryk på knappen "set" for at gå ind.	
Parameteret "CF9" vises. Tryk på knappen "set" for at gå ind.	
Parameter "A I" vises. Brug knapperne "∇" og "∧" til at vælge parameteret "CFJ I".	
Tryk på knappen "set" for at gå ind.	
Standardværdien er "0" Brug knapperne "∇" og "∧" til at vælge alarmrelæstyringen (par. 4.5.1- Tab.1)	
Tryk på knappen "set" for at bekræfte.	
Returner automatisk til "CFJ I" Parameteret er nu gemt. Tryk tre gange på knappen "esc" for at afslutte.	

Tab.1 Alarmrelæstyring (CFJ I.)

0	Relæet er normalt deaktiveret, aktiveres af en alarm.
1	Relæet er normalt aktiveret (også med kontrol OFF) og deaktiveres af en alarm.
2	Relæet er normalt aktiveret (også med kontrol ON) og deaktiveres af en alarm.

Standardparametre

Tænd for køleren "ON" på hovedafbryderen QS, og vent, til displayet viser "OFF". Tryk samtidigt på knapperne "esc" og "set" for at gå ind i parametertype "U".	
Parameteret "PAR" vises. Tryk på knappen "set" for at gå ind.	
Parameteret "CF9" vises. Tryk på knappen "set" for at gå ind.	
Parameter "A i" vises. Brug knapperne "v" og "u" til at vælge parameteret "dEF".	
Tryk på knappen "set" for at gå ind.	
Standardværdien er "0FF". Brug knapperne "v" og "u" til at skifte fra "0FF" til "0n".	
Tryk på knappen "set" for at bekræfte.	
Returner efter et par sekunder til "0FF". Parametre nulstilles automatisk. Tryk tre gange på knappen "esc" for at gå ud.	

Fjernbetjening ON/OFF

Tænd for køleren "ON" på hovedafbryderen QS, og vent, til displayet viser "OFF". Tryk samtidigt på knapperne "esc" og "set" for at gå ind i parametertype "U".	
Parameteret "PAR" vises. Tryk på knappen "set" for at gå ind.	
Parameteret "CF9" vises. Tryk på knappen "set" for at gå ind.	
Parameter "A i" vises. Brug knapperne "v" og "u" til at vælge parameteret "A7".	
Tryk på knappen "set" for at gå ind.	
Standardværdien er "0". Brug knapperne "v" og "u" til at vælge tilstanden: (par. 4.5.1- Tab.2)	
Tryk på knappen "set" for at bekræfte.	
Returner automatisk til "A7". Parameteret er nu gemt. Tryk tre gange på knappen "esc" for at afslutte.	

Tab.2 Fjernbetjeningsmodus til/fra (A7)

0	Fjernbetjening til/fra deaktiveret
1	Fjernbetjening til/fra aktiveret sammen med lokal til/fra. Hvis der er strømsvigt, eller hvis der slukkes på hovedafbryderen, skal køleren genstartes lokalt, når strømmen er vendt tilbage.
2	Kun fjernbetjening til/fra, lokal til/fra deaktiveret









Softwareversion (skrivebeskyttet)

Tænd for køleren "ON" på hovedafbryderen QS, og vent, til displayet viser "OFF". Tryk samtidigt på knapperne "esc" og "set" for at gå ind i parametertype "U".	
Parameteret "PAR" vises. Tryk på knappen "set" for at gå ind.	
Parameteret "CF9" vises. Tryk på knappen "set" for at gå ind.	
Parameter "A i" vises. Brug knapperne "v" og "u" til at vælge parameteret "iUER".	
Tryk på knappen "set" for at gå ind.	
Softwareversionen vises	
Tryk tre gange på knappen "esc" for at afslutte.	







Aktivering af overvågning

Tænd for køleren "ON" på hovedafbryderen QS, og vent, til displayet viser "OFF". Tryk samtidigt på knapperne "esc" og "set" for at gå ind i parametertype "U".	
Parameteret "PAR" vises. Tryk på knappen "set" for at gå ind.	
Parameteret "CF9" vises. Tryk på knappen "set" for at gå ind.	
Parameter "A i" vises. Brug knapperne "v" og "u" til at vælge parameteret "SUP".	
Tryk på knappen "set" for at gå ind.	
Standardværdien er "OFF" Brug knapperne "v" og "u" til at skifte.	
Tryk på knappen "set" for at bekræfte.	
Parameteret er nu gemt. Tryk tre gange på knappen "esc" for at afslutte.	

Modbus (adresse)

Tænd for køleren "ON" på hovedafbryderen QS, og vent, til displayet viser "OFF". Tryk samtidigt på knapperne "esc" og "set" for at gå ind i parametertype "U".	
Parameteret "PAR" vises. Tryk på knappen "set" for at gå ind.	
Parameteret "CF9" vises. Tryk på knappen "set" for at gå ind.	
Parameter "A i" vises. Brug knapperne "↵" og "⏪" til at vælge parameteret "CF30".	
Tryk på knappen "set" for at gå ind.	
Standardværdien er "1" Brug knapperne "↵" og "⏪" til at ændre adressen.	
Tryk på knappen "set" for at bekræfte.	
Parameteret er nu gemt. Tryk tre gange på knappen "esc" for at afslutte.	

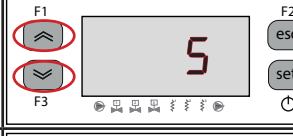
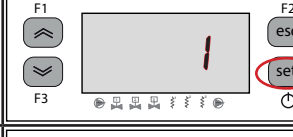





Modbus (baudrate)

Tænd for køleren "ON" på hovedafbryderen QS, og vent, til displayet viser "OFF". Tryk samtidigt på knapperne "esc" og "set" for at gå ind i parametertype "U".	
Parameteret "PAR" vises. Tryk på knappen "set" for at gå ind.	
Parameteret "CF9" vises. Tryk på knappen "set" for at gå ind.	
Parameter "A i" vises. Brug knapperne "↵" og "⏪" til at vælge parameteret "CF31".	
Tryk på knappen "set" for at gå ind.	
Standardværdien er "5" Brug knapperne "↵" og "⏪" til at ændre protokollen. (par. 4.5.1- Tab.3)	
Tryk på knappen "set" for at bekræfte.	
Parameteret er nu gemt. Tryk tre gange på knappen "esc" for at afslutte.	

Tab.3 Baudrate (tilvalg)(CF3 1)

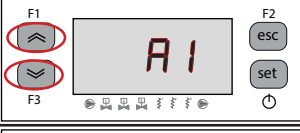
1	2400	3	9600	5	38400	7	115200
2	4800	4	19200	6	57600		

Modbus (protokol)









Tænd for køleren "ON" på hovedafbryderen QS, og vent, til displayet viser "OFF". Tryk samtidigt på knapperne "esc" og "set" for at gå ind i parameterstype "U".	
Parameteret "PAR" vises. Tryk på knappen "set" for at gå ind.	
Parameteret "CF9" vises. Tryk på knappen "set" for at gå ind.	
Parameter "A i" vises. Brug knapperne "⏪" og "⏩" til at vælge parameteret "CF32".	
Tryk på knappen "set" for at gå ind.	
Standardværdien er "1" Brug knapperne "⏪" og "⏩" til at ændre baudraten. (par. 4.5.1- Tab.4)	
Tryk på knappen "set" for at bekræfte.	
Parameteret er nu gemt. Tryk tre gange på knappen "esc" for at afslutte.	

Tab.4 Protokol-modbus (tilvalg)(CF32)

1	EVEN (LIGE)	2	NONE (INGEN)	3	ODD (IKKE LIGE)
---	-------------	---	--------------	---	-----------------

 **Bemærk:** Hvis du ændrer MODBUS-parametrene, skal du slå køleren fra og derefter igen slå den til for at validere de nye parametre.

Aktivering af ERD

Tænd for køleren "ON" på hovedafbryderen QS, og vent, til displayet viser "OFF". Tryk samtidigt på knapperne "esc" og "set" for at gå ind i parameterstype "U".	
Parameteret "PAR" vises. Tryk på knappen "set" for at gå ind.	
Parameteret "CF9" vises. Tryk på knappen "set" for at gå ind.	
Parameter "A i" vises. Brug knapperne "⏪" og "⏩" til at vælge parameteret "Er-d".	
Tryk på knappen "set" for at gå ind.	
Standardværdien er "OFF" Brug knapperne "⏪" og "⏩" til at skifte.	
Tryk på knappen "set" for at bekræfte.	
Parameteret er nu gemt. Tryk tre gange på knappen "esc" for at afslutte.	

 **Aktiver med ERD-parameter:** Den indstillede vandtemperatur ændres med den omgivende temperatur. Funktionen er kun aktiv, hvis temperaturens præcisionsstyring deaktiveres (CPT=OFF).

4.6.2 Temperaturstyring "CNP"

Temperaturstyringsindstilling

Tænd for køleren "ON" på hovedafbryderen QS, og vent, til displayet viser "OFF". Tryk samtidigt på knapperne "esc" og "set" for at gå ind i parametertype "U".	
Parameteret "PAR" vises. Tryk på knappen "set" for at gå ind.	
Parameteret "CF9" vises. Brug knapperne "v" og "a" til at vælge parameteret "CNP".	
Tryk på knappen "set" for at gå ind.	
Parameteret "SEt" vises. Tryk på knappen "set" for at gå ind.	
Standardværdien er "13.0" Brug knapperne "v" og "a" til at ændre værdien.	
Tryk på knappen "set" for at bekræfte.	
Parameteret er nu gemt. Tryk tre gange på knappen "esc" for at afslutte.	

Vigtigt: En indstilling af temperaturen mellem 1 °C og 5 °C skal udføres af specialiserede teknikere, der skal anvende den specifikke servicevejledning til dette produkt.

Regulering af temperaturredifferentialet

Tænd for køleren "ON" på hovedafbryderen QS, og vent, til displayet viser "OFF". Tryk samtidigt på knapperne "esc" og "set" for at gå ind i parametertype "U".	
Parameteret "PAR" vises. Tryk på knappen "set" for at gå ind.	
Parameteret "CF9" vises. Brug knapperne "v" og "a" til at vælge parameteret "CNP".	
Tryk på knappen "set" for at gå ind.	
Parameteret "SEt" vises. Brug knapperne "v" og "a" til at vælge parameteret "dIF".	
Tryk på knappen "set" for at gå ind.	
Standardværdien er "4.0" Brug knapperne "v" og "a" til at ændre værdien.	
Tryk på knappen "set" for at bekræfte.	
Parameteret er nu gemt. Tryk tre gange på knappen "esc" for at afslutte.	

4.6.3 Sondeparameter "bt 1"

Sonde "bt 1".

Tænd for køleren "ON" på hovedafbryderen QS, og vent, til displayet viser "OFF". Tryk samtidigt på knapperne "esc" og "set" for at gå ind i parameterstype "U".	
Parameteret "PAR" vises. Tryk på knappen "set" for at gå ind.	
Parameteret "CF9" vises. Brug knapperne "V" og "A" til at vælge parameteret "bt 1".	
Tryk på knappen "set" for at gå ind.	
Parameteret "HA 1" vises. Tryk på knappen "set" for at gå ind.	
Standardværdien er "60.0" Brug knapperne "V" og "A" til at ændre værdien.	
Tryk på knappen "set" for at bekræfte.	
Parameteret er nu gemt. Tryk tre gange på knappen "esc" for at afslutte.	

Samme sekvens for sonde "bt2".

4.7 Visualisering af sonde/ ventilator/Kompressor

Køler i gang. Tryk på knappen "A" for at se sonderne..... bt 1, bt 2, bt 3, bP 1.....	
Vælg sonde og vent nogle sekunder. (Es. BT2)	
Værdien for sonden bt 2 vises.	
Det anbefales altid at returnere til sonde bt 1	

Beskrivelse:

bt 1 : temperaturføler i vandudløb
 bt 2 : fordampers temperaturføler
 bt 3 : temperaturføler for omgivelsestemperatur
 bt 10 : temperaturføler for Elektrisk panel (valgmulighed)
 bP 1 : kredsløb 1 transducer
 bP 2 : kredsløb 1 transducer; (fra model ICEP080)









F___ : ventilatordrift:

F___ : ventilator slukket
 F-- : ventilator 1 tændt, ventilator 2,3 slukket; (2 = fra model ICEP022) (3 = fra model ICEP080)
 F-- : ventilator 1 og 2 tændt, fan 3 slukket; (2 = fra model ICEP022) (3 = fra model ICEP080)
 F-- : ventilator 1,2 og 3 tændt (from model ICEP080)

ICE : kompressorernes drift:

ICE : kompressorer deaktiveret
 ICE- : kompressorer slukket
 ICE- : kompressor 1 tændt, kompressor 2 slukket
 ICE : kompressorer 1 og 2 tændt; (fra model ICEP055)
 ICE- : med blinkende "1" kompressor klar til start, kompressor 2 slukket

4.8 Indstilling af ur/dato

Tænd for køleren "ON" på hovedafbryderen QS, og vent, til displayet viser "OFF". Tryk samtidigt på knapperne "⏪" og "⏩" for at gå ind i menuen "Dato/tid".	
Parameteret "FrEE" vises. Tryk på knappen "set" for at gå ind.	
Parameter "A," vises. Brug knapperne "⏪" og "⏩" til at vælge parameteret "CL".	
Tryk på knappen "set" for at gå ind.	
Parameteret "HOUr" vises. Tryk i 5 sekunder på knappen "set". Nu blinker parameteret.	
Brug knapperne "⏪" og "⏩" til at vælge dato, time eller år, der skal ændres.	
Tryk på knappen "set" for at gå ind.	
Brug knapperne "⏪" og "⏩" til at ændre værdien (f.eks.: år)	
Tryk på knappen "set" for at bekræfte.	

Brug knapperne "⏪" og "⏩" til at ændre en anden værdi (es:dato)



Tryk på knappen "esc" for at afslutte.
Parameteret holder op med at blinke.













Tryk samtidigt på knapperne "⏪" og "⏩" for at afslutte.



! "Ur / dato" huskes i tre dage, så hvis kontrolenheden er uden strøm i over tre dage, mistes dataindstillingen af time / måned / år.
Juster uret ved opstarten, eller når det er nødvendigt.





4.9 Alarmstyring

<p>I tilfælde af en alarm vises alarmkoden og et symbol foroven til venstre</p> <p> Kontinuerlig = alarm forefindes Blinker = advarsel forefindes/Alarm kan nulstilles</p>	
<p>Tryk på knappen "set" for at gå ind.</p>	
<p>Parameteret "ALH," vises.</p> <p>Tryk på knappen "" for at vælge parameteret "AL".</p>	
<p>Tryk på knappen "set" for at gå ind.</p>	
<p>Kodealarmen vises, f.eks.:"Er04".</p> <p>Tryk på knappen "" for at kontrollere, om der er flere alarmer.</p>	
<p>Reparer fejlen, inden der udføres nulstilling.</p> <p>Når fejlen er afhjulpnet, begynder alarmsymbolet at blinke.</p> <p>Nu kan du udføre nulstillingen.</p>	
<p>Tryk på knappen "esc", indtil alarmeren vises.</p>	

Alarm-/advarselstabe

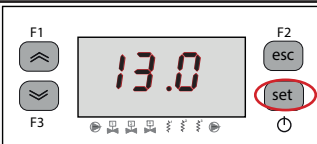
Kode	Beskrivelse	Handling	Reset
Er01	Sensor bt1 afbrudt eller defekt	Alarm	M
Er02	Sensor bt2 afbrudt eller defekt	Alarm	M
Er03	Sensor bt3 afbrudt eller defekt	Alarm	A
Er05	Sensor bt10 afbrudt eller defekt	Alarm	A
Er06	Sensor bP1 afbrudt eller defekt	Alarm	M
Er08	Højtrykskontakt kredsløb 1	Alarm	M
Er09	Lavtrykskontakt kredsløb 1	Alarm	M
Er12	Høj temperatur bt1	Alarm	M
Er13	Lav temperatur bt1	Alarm	A
Er14	Høj temperatur bt2	Alarm	M
Er15	Lav temperatur bt2	Alarm	M
Er16	Høj temperatur bt3	Alarm	A
Er17	Lav temperatur bt3	Alarm	A
Er18	Kompressor termisk beskyttelse 1	Alarm	M
Er20	Kompressor termisk beskyttelse 1	Alarm	M
Er22	Lav vandstand/Differentialtrykkontakt	Alarm	M
Er23	Fasemonitor	Alarm	M
Er24	Ekspansion defekt eller afbrudt	Alarm	M
Er25	Kompressor 1, for mange arbejdstimer	Advarsel	M
Er27	Enhedens arbejdstimer oversteget	Advarsel	M
Er28	Urhukommelse	Advarsel	A
Er29	Kølerkonfiguration	Advarsel	A

4.10 Alarmhistorik

Køler i gang. Tryk på knappen "set" for at se alarmhistorikken.	
Tryk på knappen "set" for at gå ind.	
Brug knapperne "⏪" og "⏩" til at se parametrene. (Par. 4.5.5)	
Tryk på knappen "set" for at se værdien.	

5 Vedligeholdelse

- Maskinen er projekteret og konstrueret til at sikre løbende drift; dens komponenters levetid afhænger dog direkte af den udførte vedligeholdelse.
-  Ved henvendelse om service eller reservedele, identificér maskinen (model og serienr.), der fremgår af fabrikkationspladen udenpå maskinen. (www.polewr.com)

5.1 Generelle advarsler

 Før enhver form for vedligeholdelse, kontrolleres det, at køleanlægget ikke er tilsluttet strømforsyningen.

 Brug altid producentens originale reservedele: hvis dette overholdes, fritages producenten for ethvert ansvar for maskinens dårlige funktion.

 Ved spild af kølevæske skal man kontakte kompetent og autoriseret personale.

 Ventilen Schrader skal kun bruges ved unormal funktion af maskinen: i modsat fald anerkendes fejl som følge af forkert påfyldning af kølevæske ikke under garantien.

5.2 Kølevæske













Påfyldning: eventuelle skader fremkaldt af forkert påfyldning udført af uautoriseret personale anerkendes ikke under garantien. 

 Udstyret indeholder fluorholdige gasser med drivhuseffekt
Den kuldefrembringende væske R513A ved normal temperatur og tryk er en ufarvet gas, der hører til SAFETY GROUP A1 - EN378 (væske gruppe 2 i henhold til direktiv PED 2014/68/EU); GWP (Global Warming Potential) = 629.

 I tilfælde af udslip af kølevæske udluftes lokalet.

5.3 Program preventivní údržby

For at kunne garantere at chilleren yder maksimalt og er pålidelig, skal følgende udføres:

Beskrivelse af vedligeholdelsesaktiviteter	Vedligeholdelsesinterval (for standarddrift)			
	Hver dag	hver 6. måned	hver 12. måned	hver 36. måned
Aktivitet kontroller  Service 				
Kontroller, at kontrollampen POWER ON er tændt.				
Kontroller kontrolpanelets kontrollamper.				
Rengør kondensatorens ribber.				
Kontroller elforbruget.				
Kontrollér udslip af kølevæske.				
Kontroller og rengør sikkerhedsventilen (hvis den findes)*				
Kontrollér elektriske system og den elektriske tavle.**				
Styr temperaturkontrol. Udskift dem om nødvendigt.				 
Vedligeholdelsessæ				



Følgende er tilgængelige på komplet manual (viz částr 7.):

- servicesæt: elektrisk sæt; kompressorsæt; ventilatorsæt; fordampersæt; pumpesæt; vandbeholdersæt;
- individuelle reservedele.

*For at sikre fuld effektivitet skal sikkerhedsventiler kontrolleres med jævne mellemrum.

Over tid kan urenheder sætte sig i nærheden af stikket; derfor er periodisk skylning af sædet nødvendig. En sådan skylning opnås ved manuelt at dræne ventilen ved at dreje knappen i den retning, pilene angiver.

Vigtigt: Sørg for, efter denne operation, at driftstrykket er genoprettet.

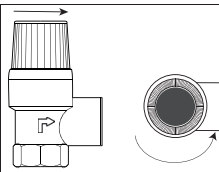



Under den periodiske vedligeholdelse skal det elektriske system på maskinen og den elektriske tavle også kontrolleres i henhold til lokal lovgivning. Desuden bør en visuel inspektion af udstyret og de elektriske ledere altid udføres, hvor det er muligt, og den korrekte tilspænding af strømkomponenternes klemmer skal også kontrolleres i henhold til de tilspændingsmomenter, der er angivet i det

elektriske diagram.

5.4 Demontering

Den kuldefrembringende væske og smøreolien i kredsløbet skal genvindes i henhold til de gældende miljøregler.

Der skal foretages opsamling af kølevæsken inden den endelige bortskaffelse af apparaturet ((EU) Nr. 517/2014 art. 8).

	GENBRUG BORTSKAFFELSE 
tømrerarbejde	stål/epoxyharpiks, polyester
tank	aluminium/kobber/stål
rør/samlerør	kobber/aluminium/kulstofstål
rørens isolering	nitrilgummi (NBR)
kompressor	stål/kobber/aluminium/olie
kondensator	stål/kobber/aluminium
pumpe	stål/støbejern/messing
blæser	aluminium
kølevæske	R513A
ventiler	messing/kobber
elkabler	kobber/PVC

Udstyr, der indeholder elektriske komponenter, skal bortskaffes separat indsamlet sammen med elektrisk og elektronisk affald i henhold til lokal og gældende lovgivning.



6 Fejlsøgning

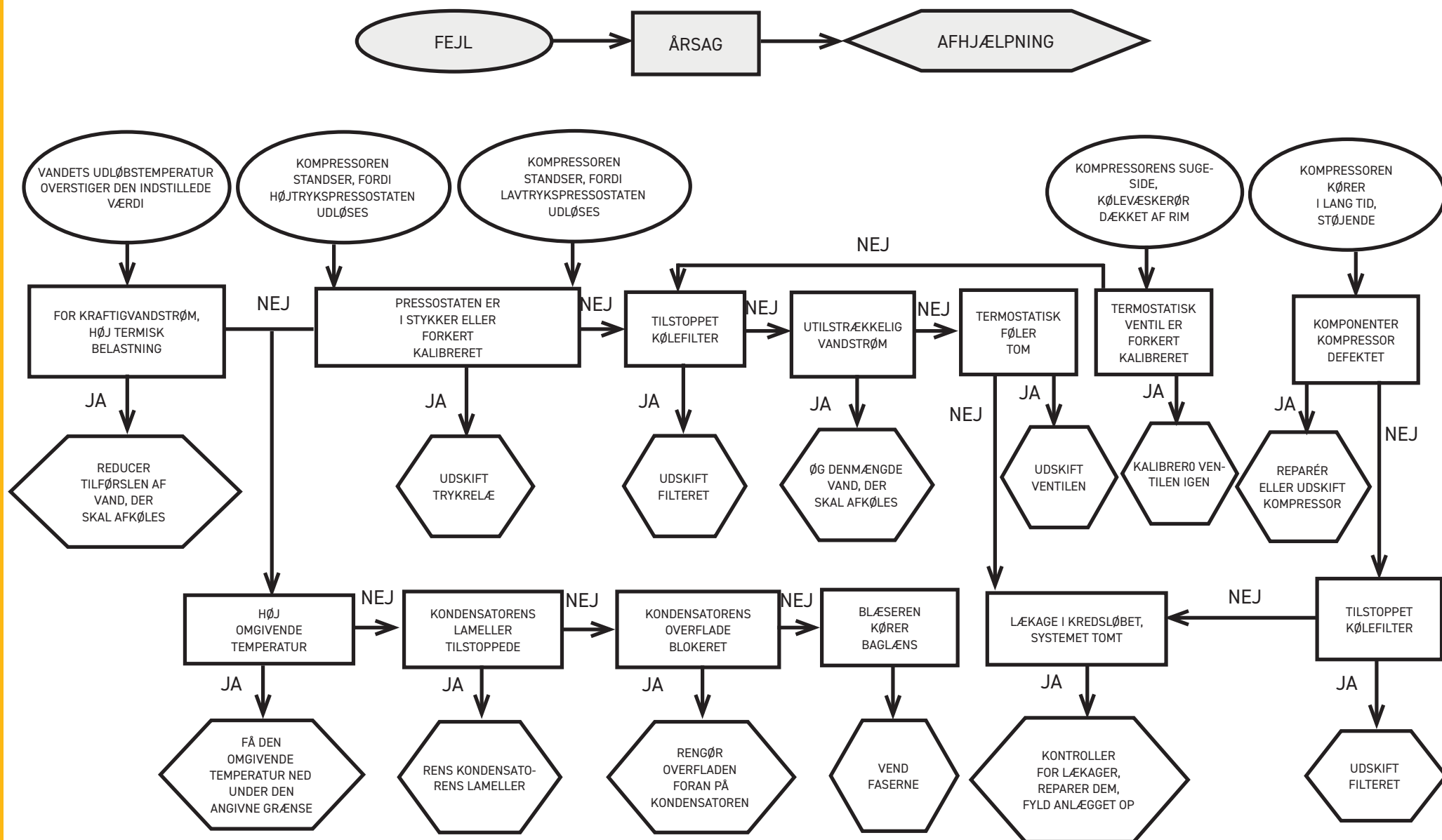

1 Bezpieczeństwo	2
1.1 Istotność instrukcji.....	2
1.2 Sygnalizacja ostrzegawcza.....	2
1.3 Wskazówki dotyczące bezpieczeństwa.....	2
1.4 Pozostałe zagrożenia.....	2
2 Wprowadzenie	3
2.1 Transport.....	3
2.2 Przenoszenie.....	3
2.3 Inspekcja.....	3
2.4 Magazynowanie.....	3
3 Instalacja	3
3.1 Przestrzeń robocza.....	3
3.2 Wersje.....	3
3.3 Obwód hydrauliczny.....	3
3.3.1 Kontrole i podłączenie.....	3
3.3.2 Woda i glikol etylenowy.....	4
3.3.3 Zbiornik wyrównawczy.....	4
3.4 Obwód elektryczny.....	5
3.4.1 Kontrole i podłączenia.....	5
3.4.2 Alarm ogólny.....	5
3.4.3 Zdalny wyłącznik ON/OFF.....	5
3.5 Wersja chłodzona wodą (W)	5
4 Sterowanie	6
4.1 Panel sterowania.....	6
4.2 Znaczenie symboli.....	6
4.3 Uruchamianie agregatu chłodniczego.....	6
4.3.1 Regulacje podczas pierwszego uruchomienia.....	6
4.3.2 Zaczynając od wody o wysokiej temperaturze.....	6
4.4 Zatrzymanie.....	7
4.5 Ustawienia parametrów.....	7
4.5.1 Parametry agregatu chłodniczego (CF9).....	7
4.5.2 Regulacja temperatury (CNP).....	7
4.5.3 Parametry konserwacji (FLN).....	7
4.5.4 Parametry sondy (bŁ 1, bŁ 2).....	7
4.5.5 Historia alarmów (RLH 1).....	7
4.6 Zmiana parametrów (User).....	8
4.6.1 Parametry agregatu chłodniczego „CF9”.....	8
4.6.2 Regulacja temperatury „CNP”.....	13
4.6.3 Parametry sondy „bŁ 1”.....	14
4.7 Wyświetlenie sonda/ wentylator/ kompresor.....	14
4.8 Ustawianie zegara/daty.....	15
4.9 Zarządzanie alarmami.....	16
4.10 Historia alarmów.....	17
5 Konserwacja	17
5.1 Uwagi ogólne.....	17
5.2 Czynnik chłodniczy.....	17
5.3 Program konserwacji prewencyjnej.....	18
5.4 Demontaż.....	18





7 Aneks
7.1 Legenda
7.2 Schemat instalacji
7.3 Przenoszenie - Przestrzeń robocza
7.4 Dane techniczne
7.5 Wymiary
7.6 Lista części zamiennych
7.7 Rysunki rozstrzelone
7.8 Schemat obwodu
7.9 Schemat elektryczny

1 Bezpieczeństwo

1.1 Istotność instrukcji

- Przechowywać ją przez cały okres eksploatacji maszyny.
- Przeczytać ją przed przystąpieniem do jakichkolwiek czynności.
- Podlega zmianom: w celu aktualizacji informacji, zapoznać się z instrukcją dołączaną do maszyny.

1.2 Sygnalizacja ostrzegawcza

	Polecenie w celu wyeliminowania zagrożeń dla osób.
	Polecenie, którego należy przestrzegać w celu wyeliminowania ryzyka uszkodzenia urządzenia.
	Wymagana obecność upoważnionego, doświadczonego technika.
	Wymagana obecność upoważnionego, doświadczonego technika.

1.3 Wskazówki dotyczące bezpieczeństwa

 Każde urządzenie wyposażone jest w odłącznik elektryczny umożliwiający przeprowadzenia interwencji w bezpiecznych warunkach. Odłącznika należy używać zawsze do wyeliminowania ryzyka podczas konserwacji.

 Instrukcja przeznaczona jest dla użytkownika końcowego i dotyczy wyłącznie czynności wykonywanych przy zamkniętych panelach: czynności wymagające instalacja/pierwszego uruchomienia/konserwacja ich otwarcia przy pomocy narzędzi mogą być wykonywane przez doświadczonego i wykwalifikowanego personel.

 Do montażu wyłącznie w miejscach niedostępnych dla ogółu społeczeństwa, w miejscach zabezpieczonych z ograniczonym dostępem lub na wysokości nie mniejszej niż 2,5 m lub na zabezpieczonych obszarach dachowych, chyba że osoba odpowiedzialna za ich bezpieczeństwo zapewni im nadzór lub przekaze im instrukcje dotyczące korzystania z urządzenia.

 Odległość montażowa od ściany i wolna przestrzeń robocza podane są w punkcie 7.3.

 Uwaga: należy przestrzegać wartości temperatury i ciśnienia min./maks. wskazanych w pkt 7.4 oraz całkowitego zakresu temperatur roboczych wskazanego w pkt 7.2.

 Wszystkie jednostki mogą być instalowane na zewnątrz.

 Wszystkie połączenia elektryczne muszą być zgodne z lokalnymi przepisami w miejscu instalacji.

 Nie przekraczać ograniczeń projektowych podanych na tabliczce znamionowej.

 Użytkownik jest zobowiązany nie dopuścić do działania innych obciążeń oprócz wewnętrznego ciśnienia statycznego. W razie zaistnienia niebezpieczeństwa wstrząsów sejsmicznych, należy odpowiednio zabezpieczyć urządzenie.

Urządzenia należy używać wyłącznie do zastosowań profesjonalnych i do celu, do którego zostało przeznaczone.

 Użytkownik ma obowiązek przeanalizowania wszystkich aspektów zastosowania i miejsca instalacji produktu, przestrzegania wszystkich stosownych standardów bezpieczeństwa przemysłowego oraz wszystkich zaleceń dotyczących produktu zawartych w instrukcji obsługi oraz wszelkiej innej dokumentacji dołączonej do urządzenia.

Przeróbki lub wymiana jakiegokolwiek komponentu przez osoby nieupoważnione i/lub nieprawidłowa obsługa urządzenia powodują u nieważnienie gwarancji i zwalniają producenta z jakiegokolwiek odpowiedzialności.

Producent nie ponosi odpowiedzialności teraz ani w przyszłości za szkody doznane przez osoby, mienie i samo urządzenie wynikłe z zaniedbań ze strony operatorów, nieprzestrzegania wskazówek podanych w niniejszej instrukcji oraz niezastosowania obowiązujących norm odnośnie bezpieczeństwa instalacji.

Producent nie ponosi odpowiedzialności za ewentualne szkody wynikłe wskutek zmiany i/lub modyfikacji opakowania.

Użytkownik ma obowiązek upewnić się, że dane techniczne niezbędne do wyboru urządzenia lub jego komponentów i/lub opcji są wyczerpujące w celu zagwarantowania prawidłowej lub przewidywalnej obsługi i eksploatacji samego urządzenia lub jego komponentów.

 **UWAGA: Producent zastrzega sobie prawo do zmiany informacji zawartych w niniejszej instrukcji bez uprzedniego powiadomienia. Aby zawsze uzyskać pełne i aktualne informacje, użytkownik powinien zawsze przechowywać instrukcje w pobliżu urządzenia.**

1.4 Pozostałe zagrożenia

Instalacja, uruchomienie, wyłączenie, konserwacja maszyny muszą być kategorycznie wykonywane zgodnie z dokumentacją techniczną produktu a w każdym razie unikając stworzenia jakiegokolwiek zagrożenia.

Zagrożenia, których nie można było wyeliminować w fazie projektowania, podano w poniższej tabeli.

część maszyny	ryzyko resztkowe	metodologia	środki ostrożności
bateria wymiany termicznej	niewielkie rany cięte	kontakt	unikać kontaktu, używać rękawic ochronnych
kratka wentylatora i wentylator	uszkodzenia	wkładanie ostrych przedmiotów przez kratkę podczas pracy wentylatora	nie wkładać przedmiotów jakiegokolwiek rodzaju do kratki wentylatorów i nie kłaść przedmiotów na kratkach
wnętrze jednostki: sprężarka i rura doprowadzająca	oparzenia	kontakt	unikać kontaktu, używać rękawic ochronnych

część maszyny	ryzyko resztkowe	metodologia	środki ostrożności
wnętrze jednostki: części metalowe i kable elektryczne	zatrucia, porażenie prądem, poważne oparzenia	wada izolacji kabli zasilających przed tablicą elektryczną jednostki części metalowe pod napięciem	ochrona elektryczna odpowiednia do linii zasilającej; maksymalna dbałość przy podłączaniu uzimienia części metalowych
na zewnątrz jednostki: obszar przylegający do jednostki	zatrucia, poważne oparzenia	pożar z powodu krótkiego spięcia lub przegrzania lub przegrzania linii zasilającej przed tablicą elektryczną jednostki	przekrój kabli i system osłon elektrycznej linii zasilającej zgodne z obowiązującymi normami

2 Wprowadzenie

Silniki sprężarki, pompy i wentylatora są wyposażone w osłonę termiczną chroniącą je przed ewentualnymi przegrzaniem.

2.1 Transport

Zapakowana jednostka musi być:

- w pozycji pionowej;
- chroniona przed wpływem czynników atmosferycznych;
- chroniona przed uderzeniami.

2.2 Przenoszenie

Używać wózka podnośnikowego widłowego dostosowanego do podnoszonego ciężaru, unikając jakichkolwiek uderzeń.

2.3 Inspekcja

- W fabryce wszystkie jednostki są montowane, wyposażane w okablowanie, napełniane czynnikiem chłodniczym i olejem oraz przechodzą odbiór techniczny;
- Po odbiorze maszyny sprawdzić jej stan: zgłaszać bezzwłocznie firmie przewoźowej ewentualne uszkodzenia;
- rozpakować jednostkę jak najbliżej miejsca instalacji.

2.4 Magazynowanie

- Przechowywać jednostkę w opakowaniu w miejscu czystym i chronionym przed wilgocią i złymi warunkami atmosferycznymi.
- nie ustawiać jednostek na sobie;
- postępować zgodnie z instrukcjami na opakowaniu.

3 Instalacja

 Wskazówki odnośnie optymalnej instalacji podano w paragrafach.7.

 Zainstalowany produkt musi być odpowiednio zabezpieczony przed zagrożeniem pożarowym (odn. EN378-3).

 **Zaleca się zamontowanie w agregatach chłodniczych odpowiedniego filtra wstępnego w pobliżu wlotu wody (filtra stopniu: min.05mm; max1.0mm).**

 **Ciecze do chłodzenia**

Ciecze do chłodzenia muszą być kompatybilne z użytymi materiałami.

Przykładowo stosowanymi cieczami są **woda lub mieszanina wody oraz glikolu etylenowego lub propylenu**.

Ciecze do chłodzenia nie mogą być palne.

Jeśli płyn chłodzący zawiera niebezpieczne substancje (np. glikol etylenowy/propylenowy), ewentualne wycieki płynu należy zbierać, ponieważ są szkodliwe dla środowiska. W razie opróżniania układu hydraulicznego, należy przestrzegać obowiązujących przepisów i nie wylewać zawartości instalacji bezpośrednio do środowiska.

3.1 Przestrzeń robocza

 **Zostawić przestrzeń 1.5 m wokół jednostki.**

Zostawić przestrzeń 2 m nad osuszaczem w przypadku modeli z pionowym wyrzutem powietrza kondensacyjnego

3.2 Wersje

Wersja powietrzna: Wentylatory osiowe (A)

Unikać recyrkulacji powietrza chłodzącego.

Nie zatykać kratki wentylacyjnych.

Dla wersji z wentylatorami osiowymi nie zaleca się odprowadzania rurami zużytego powietrza.

Wersja chłodzona wodą (W)

Jeżeli woda w kondensatorze znajduje się w obiegu otwartym, zainstalować filtr sieciowy nawęściu wody służącej do kondensacji.

W przypadku szczególnego rodzaju wody użytej do chłodzenia (dejonizowana, demineralizowana, destylowana) standardowe materiały przewidziane dla kondensatorów mogą okazać się nieodpowiednie. W takich przypadkach zaleca się kontakt z producentem.

3.3 Obwód hydrauliczny

3.3.1 Kontrole i podłączenie

 Przed podłączeniem agregatu i napełnieniem obwodu upewnić się, czy przewody rurowe są czyste. W przeciwnym wypadku należy je dokładnie umyć.

  **Jeżeli obieg wody jest obiegiem zamkniętym, w części ciśnieniowej zainstalowany jest zawór bezpieczeństwa 6 bar.**

 Na rurach doprowadzających i odprowadzających wodę zaleca się zawsze instalować filtry siatkowe.

 Jeśli obieg hydrauliczny zostanie przejęty przez zawory automatyczne, zabezpieczyć pompę systemami chroniącymi przed uderzeniami.

 Jeśli obwód zostanie opróżniony na dłuższy okres spoczynku, zaleca się dodanie płynu smarującego na wirnik pompy, aby uniknąć jego zablokowania się przy ponownym uruchamianiu. W przypadku zablokowania się wirnika przystąpić do odblokowania ręcznego. Zdjąć pokrywę tylną pompy i delikatnie obrócić plastikowy wentylator. Jeśli wał pozostaje nadal zablokowany, zdjąć wentylator i obracać bezpośrednio wał. Po odblokowaniu wirnika, należy ponownie założyć wentylator i pokrywę.

Kontrole wstępne

1. Sprawdzić, czy ewentualne zawory odcinające obwodu hydraulicznego są otwarte.
2. Jeśli obwód hydrauliczny jest typu zamkniętego, sprawdzić, czy został zamontowany zbiornik wyrównawczy o odpowiedniej pojemności.

Connection

1. Podłączyć chłodziarkę wody do przewodów wejściowych i wyjściowych stosując odpowiednie połączenia, znajdujące się w tylnej części urządzenia. Zaleca się użycie złączy giętkich aby zmniejszyć sztywności układu.
2. Napełnić obwód hydrauliczny korzystając z właściwego przyłącza umieszczonego w tylnej części agregatu ().
3. Zbiornik jest wyposażony w odpowiedni zawór odpowietrzający, który powinien być załączany ręcznie w momencie napełniania. W tym celu, jeśli w obiegu hydraulicznym są punkty o wyższej wysokości, należy tam zainstalować zawory odpowietrzające.
4. Zaleca się wyposażenie rur wlotowych i wylotowych w kurek tak, by można było wyłączyć maszynę z obwodu w przypadku konserwacji.
5. Jeśli agregat pracuje z otwartym zbiornikiem, pompa musi być zainstalowana na wlocie do zbiornika i na tłoczeniu do agregatu.

 **Ostrzeżenie (modele 022-120): maszyna jest wyposażona w automatyczne urządzenie zabezpieczające zbiornik.**

Jeżeli wlot wody zostanie przypadkowo zamknięty podczas pracy pompy, a wylot wody jest otwarty, powietrze wejdzie do zbiornika z prawdopodobną interwencją czujnika poziomu. Konieczne będzie odpowietrzenie obwodu hydraulicznego w celu wyeliminowania powietrza.

Kolejne kontrole

1. Sprawdzić, czy zbiornik i obwód są całkowicie napełnione wodą i prawidłowo odpowietrzone.
2. Obieg wody powinien być zawsze wypełniony. W tym celu można stosować okresową kontrolę i uzupełnianie albo można wyposażyć instalację w zestaw do napełniania automatycznego.

Charakterystyki wody

Jeśli nie przewidziano w dostawie, zamontować filtr siatkowy na wejściu wody kondensacyjnej.

  Charakterystyki wody:

Temperatura	≥50°F (10°C)	CL ⁻	<50 ppm
ΔT IN/OUT	5-15°C	CaCO ₃	70-150 ppm
Max % glikol	50	O ₂	<0.1 ppm
Ciśnienie	43.5-145 PSIG (3-10 barg)	Fe	<0.2 ppm
PH	7.5-9	NO ₃	<2 ppm
Przewodność elektryczna	10-500 μS/cm	HCO ₃ ⁻	70-300 ppm

Indeks nasycenia Langeliera	0-1	H ₂ S	<0.05 ppm
SO ₄ ²⁻	<50 ppm	CO ₂	<5 ppm
NH ₃	<1 ppm	Al	<0.2 ppm

W przypadku szczególnego rodzaju wody użytej do chłodzenia (dejonizowana, demineralizowana, destylowana) standardowe materiały przewidziane dla chłodziarki mogą okazać się nieodpowiednie. W takich przypadkach zaleca się kontakt z producentem.

3.3.2 Woda i glikol etylenowy

Przy instalacji w miejscu odkrytym lub nieogrzewanym pomieszczeniu zamkniętym istnieje możliwość, że w okresach zatrzymania instalacji w czasie mrozów woda wewnątrz obwodu zamrze.

Aby zmniejszyć to zagrożenie:

- wyposażyć chiller w odpowiednie zabezpieczenia przeciwzamrazaniowe, dostarczane przez producenta jako opcjonalne;
- opróżnić instalację za pomocą odpowiedniego zaworu spustowego w przypadku przedłużonych postojów;
- dodać odpowiednią ilość substancji przeciwzamrazaniowej do wody obiegowej (patrz tabela).

Temperatura wody na wyjściu [°C]	Glikol etylenowy (% vol.)	Temperatura otoczenia
4	5	-2
2	10	-5
0	15	-7
-2	20	-10
-4	25	-12
-6	30	-15
-10	40	-20

3.3.3 Zbiornik wyrównawczy

Aby uniknąć wzrostu lub zmniejszenia objętości płynu spowodowanych zmianą jego temperatury, co mogłoby uszkodzić maszynę lub obwód, zaleca się zainstalowanie zbiornika wyrównawczego o odpowiedniej pojemności.

Zbiornik ekspansyjny powinien być podłączony przed pompą do tylnego gniazda zbiornika.

Aby obliczyć minimalną objętość zbiornika wyrównawczego, jaki trzeba zastosować w obwodzie zamkniętym, można postąpić następującą formułą:

$$V=2 \times V_{tot} \times (P_{t \min} - P_{t \max})$$

gdzie

V_{tot}= obj. całkowita obwodu (w litrach)

P_{t min/max}= ciężar właściwy przy minimalnej/maksymalnej temperaturze osiąganą przez wodę [kg/dm³].

Wartości ciężaru właściwego zależnie od temperatury i procentu glikolu są podane w tabeli.

% glikol	Temperatura [°C]						
	-10	0	10	20	30	40	50
0%	1.0024	1.0008	0.9988	0.9964	0.9936	0.9905	0.9869
10%	1.0177	1.0155	1.0130	1.0101	1.0067	1.0030	0.9989
20%	1.0330	1.0303	1.0272	1.0237	1.0199	1.0156	1.0110
30%	1.0483	1.0450	1.0414	1.0374	1.0330	1.0282	1.0230
40%	1.0636	1.0594	1.0525	1.0511	1.0461	1.0408	1.0350

Uwaga: Podczas napełniania zwrócić uwagę na dane dotyczące napełniania również zbiornika wyrównawczego.

Jeśli temperatura powietrza otoczenia w agregacie jest niższa niż -10°C, należy przenieść zbiornik wyrównawczy w bezpieczne miejsce po stronie powrotu wody z agregatu. Zawór bezpieczeństwa i zawór upustowy muszą pozostać w agregacie chłodniczym.

3.4 Obwód elektryczny

3.4.1 Kontrole i podłączenia

Przed przystąpieniem do jakichkolwiek czynności na częściach elektrycznych upewnić się, czy nie są pod napięciem.

Wszystkie połączenia elektryczne muszą być zgodne z lokalnymi przepisami w miejscu instalacji.

Kontrole wstępne

- Napięcie i częstotliwość sieci muszą odpowiadać wartościom odcisniętym na tabliczce znamionowej agregatu. Napięcie zasilania nie może, nawet w krótkich okresach, przekraczać tolerancji podanej na schemacie elektrycznym, która, jeśli nie podano inaczej, wynosi +/- 10% dla napięcia; +/- 1% dla częstotliwości.
- Napięcie musi być symetryczne (wartości składowych czynnych napięć i kąty faz między sąsiednimi fazami równe między sobą). Maksymalna dopuszczalna utrata równowagi między napięciami wynosi 2%.

Podłączenie

- Zasilanie elektryczne agregatów wykonywane jest kablem 4-żyłowym, 3 bieguny +uziemiaenie, bez zera. Przekrój minimalny kabla, patrz paragraf 7.
- Przewód powinien przejść przez docisk umieszczony z tyłu na tylnym panelu urządzenia. Podłączyć fazę i zero do zacisków na odłączniku głównym (QS), a uziemiaenie do zacisku uziemiającego (PE).
- Zapewnić na początku kabla zasilającego ochronę przed kontaktem bezpośrednim co najmniej IP2X lub IPXXB.
- Zainstalować, na linii zasilania elektrycznego chillera, automatyczny wyłącznik różnicowy (RCCB - IDn = 0.3A), o obciążalności maksymalnej podanej na odnośnym schemacie elektrycznym, o zdolności wyłączenia odpowiedniej do prądu zwarcowego występującego na obszarze instalacji maszyny.
Nominalny prąd wejściowy ("In") takiego wyłącznika magnetyczno-termicznego musi być równy wartości FLA oraz krzywej zadziałania typu D.
- Maksymalna wartość oporu pozornego sieci = 0.274 ohm.

Kolejne kontrole

Upewnić się, czy maszyna i urządzenia pomocnicze zostały uziemione i czy są chronione przed zwarcie i/lub przeciążeniami.

Uwaga: Po podłączeniu jednostki i zamknięciu wyłącznika głównego przed maszyną (włączając w ten sposób zasilanie maszyny), napięcie w obwodzie elektrycznym osiąga wartości niebezpieczne. Maksymalna ostrożność!!

Uwaga: Instalator odpowiada za przeprowadzanie obowiązkowych, minimalnych prób w celu zapewnienia prawidłowej instalacji elektrycznej spełniającej postanowienia lokalnych przepisów, przy jednoczesnym zastosowaniu odpowiedniego systemu uziemienia, spełniającego szczególne wymagania dotyczące systemów z izolowanym punktem neutralnym.

3.4.2 Alarm ogólny

Wszystkie chillery posiadają sygnalizację alarmu maszyny (patrz schemat elektryczny), którą tworzy wolny styk zwrotniczy wstawiony do skrzynki zaciskowej: pozwala to na przyłączenie centralnego alarmu zewnętrznego, dźwiękowego, wizualnego lub podłączonego do np. PLC.

3.4.3 Zdalny wyłącznik ON/OFF

Wszystkie chillery mają możliwość zastosowania zdalnego sterowania uruchamianiem i zatrzymaniem (paragraf 7.).

- Aby włączyć zdalne rif. n.16387

- Jako zmienna odniesienia ON/OFF rif.n.8996

Uwaga: nie włączaj jednocześnie „Sup” i „Re” .

Podłączenie oddalonego przełącznika ON-OFF widoczne jest na schemacie elektrycznym (paragraf 7.)

3.5 Wersja chłodzona wodą (W)

Chillery w wersji z kondensacją wodną wymagają obwodu hydraulicznego doprowadzającego zimną wodę do kondensatora.

Chłodziarkawwersjiwodnejwyposażonajestwzawór ciśnieniowy, znajdujący się na wejściu do kondensatora, który ma za zadanie regulowanie natężenia przepływu wody, zapewniając optymalną kondensację.

Kontrole wstępne

Jeśli zasilanie wodą kondensatora jest wykonane za pomocą obwodu zamkniętego, przeprowadzić wszystkie kontrole wstępne wyszczególnione dla głównego obwodu hydraulicznego (par. 3.3.1).





Podłączenie

- Zaleca się wyposażenie obwodu wody kondensacyjnej w zawory odcinające tak, by można było wyłączyć maszynę w przypadku konserwacji.
- Podłączyć rury doprowadzające/odprowadzające wodę do odpowiednich przyłączy umieszczonych w tylnej części jednostki.
- Jeśli woda kondensacyjna jest w obiegu otwartym, zaleca się wyposażenie obwodu w filtr na wejściu kondensator tak, by ograniczyć ryzyko zabrudzenia powierzchni.
- Jeśli obwód jest typu zamkniętego, skontrolować, czy jest prawidłowo wypętniony wodą i prawidłowo odpowietrzony.









4 Sterowanie

4.1 Panel sterowania



-  Przycisk DO GÓRY: nacisnąć przycisk w celu zwiększenia wartości wybranego parametru edytowalnego.
-  Przycisk W DÓŁ: nacisnąć przycisk w celu zmniejszenia wartości wybranego parametru edytowalnego.
-  Przycisk ESC: służy do wychodzenia bez zapisywania; powoduje powrót do poprzedniego poziomu;
NACIŚNIĘTY PRZEZ 5 s powoduje RESET ALARMU.
-  Przycisk SET: służy do wychodzenia i zapisywania/ potwierdzania wartości; powoduje przejście do następnego poziomu. Jego naciśnięcie powoduje wejście do menu ustawień;
NACIŚNIĘTY PRZEZ 5 s powoduje URUCHOMIENIE AGREGATU CHŁODNICZEGO.

4.2 Znaczenie symboli

Symbol	Stan symbolu	Funkcja	Symbol	Stan symbolu	Funkcja
	świeci się	Sprężarka włączona		świeci się	Wartość temperatury
	miga	Sprężarka w trybie czuwania		świeci się	Wartość ciśnienia
	Wył.	Sprężarka wyłączona		Wył.	Podgrzewacz płynu przeciw zamarzaniu WŁ.
	świeci się	Występuje alarm		świeci się	Podgrzewacz płynu przeciw zamarzaniu WYŁ.
	miga	Ostrzeżenie lub Alarm do skwitowania		Wył.	Podgrzewacz skrzyni korbowej WŁ. Sprężarka 1
	Wył.	Brak alarmu		Wył.	Podgrzewacz skrzyni korbowej WYŁ. Sprężarka 1
	świeci się	Pompa 1 WŁ.		świeci się	Podgrzewacz skrzyni korbowej WŁ. Sprężarka 2 (brak)
	Wył.	Pompa 1 WYŁ.		Wył.	Podgrzewacz skrzyni korbowej WYŁ. Sprężarka 2 (brak)
	świeci się	Pompa 2 WŁ. (brak)		świeci się	Podgrzewacz skrzyni korbowej WYŁ. Sprężarka 2 (brak)
	Wył.	Pompa 2 WYŁ. (brak)		Wył.	Podgrzewacz skrzyni korbowej WYŁ. Sprężarka 2 (brak)

4.3 Uruchamianie agregatu chłodniczego

- Podłączyć maszynę do zasilania poprzez obrócenie wyłącznika sieciowego QS w położenie ON (WŁ.).
- Nacisnąć przycisk "set" aby uruchomić urządzenie.
- Ustawić na kontrolerze żadaną temperaturę. (punkt 4.5.1)

Monitor fazy

Jeżeli na wyświetlaczu pojawia się alarm "E-23", użytkownik musi sprawdzić, czy zaciski na wejściu odłącznika zostały prawidłowo okablowane.

4.3.1 Regulacje podczas pierwszego uruchomienia

- Ustawianie temperatury wody, patrz rozdział 4.5.
- Za pomocą manometru sprawdzić prawidłowe działanie pompy (odczytać P1 i P0) oraz wartości graniczne ciśnienia (Pmax i Pmin) podane na tabliczce znamionowej pompy.
P1 = ciśnienie przy włączonej pompie
P0 = ciśnienie przy wyłączonej pompie
 $P_{min} < (P1 - P0) < P_{max}$
- Przykład nr 1.
Warunki:
obwód zamknięty z ciśnieniem P0 wynoszącym 2 bar
dane z tabliczki znamionowe pompy: Pmin 1bar/ Pmax 3bar
wyregulować wyjście zaworu na ciśnienie 3 bar < P1 < 5 bar
- Przykład nr 2.
Warunki:
obwód otwarty z ciśnieniem P0 wynoszącym 0 bar
dane z tabliczki znamionowe pompy: Pmin 1bar/ Pmax 3bar
wyregulować wyjście zaworu na ciśnienie 1 bar < P1 < 3 bar
- Sprawdzić prawidłowe działanie pompy również w warunkach pracy.
Sprawdzić ponadto, czy natężenie prądu elektrycznego w pompie mieści się w granicach podanych na tabliczce znamionowej.
- Wyłączyć agregat chłodniczy i napełnienia obwodu hydraulicznego przy temperaturze „SET”.
- Sprawdzić, czy temperatura wody procesowej nie spada poniżej 5°C, a temperatura otoczenia, w której pracuje obwód hydrauliczny, nie spada poniżej 5°C. Jeśli tak, dodać do wody odpowiednią ilość glikolu zgodnie z instrukcjami w rozdziale 3.3.3

 **UWAGA:** przed włączeniem pompy agregatu do schładzania zamknąć zawór wylotowy wody (którego instalacja leży w zakresie klienta).

Zawsze trzymać zawór wlotowy (którego instalacja leży w zakresie klienta) otwarty.

Włączyć pompę, powoli otworzyć zawór wylotowy wody agregatu do schładzania i wyregulować natężenie przepływu zgodnie z opisem w punkcie 4.3.1.

4.3.2 Zaczynając od wody o wysokiej temperaturze

W przypadku, gdy temperatura wody w obiegu jest wysoka (na przykład 30-35°C), stopniowo zamknij (ale nie całkowicie, około dwóch trzecich!) zawór odcinający (opieką klienta) na wylocie chłodziarki, aby zmniejszyć przepływ wody przez jednostkę. Stopniowo otwieraj zawór, gdy tylko temperatura wody spadnie do wartości roboczej.

Ważne: w tym stanie mogą wystąpić liczne alarmy wysokiego ciśnienia, które należy ręcznie zresetować. Ważne: ta regulacja pozwala również uniknąć uderzeń wodnych wzdłuż rur spowodowanych obecnością kieszeni powietrznych w obwodzie (kieszenie powietrzne muszą zostać wyeliminowane przez zawory odpowietrzające w najwyższych punktach obwodu hydraulicznego pod opieką

klidenta).

4.4 Zatrzymanie

Kiedy niepotrzebne jest już działanie chillera, należy wyłączyć go następujący sposób: Naciśnąć przycisk "set" (5 Sec.) .

Nie przestawiać na off odłącznika głównego QS [P0] tak, by zapewnić zasilanie ewentualnych grzałek przeciwzamarzaniowych w agregacie.

4.5 Ustawienia parametrów

Menu ogólne

Występują parametry z dwoma poziomami zabezpieczenia:

a) Bezpośrednie User-(U): możliwy jest bezpośredni dostęp i **zmiana przez użytkownika**;

b) Zabezpieczone hasłem Service-(S); w celu uzyskania dostępu wymagane jest wprowadzenie hasła (**nie należy ich zmieniać**).

4.5.1 Parametry agregatu chłodniczego (CF9)

PARAMETR	KOD	TYP	USTAWIENIE DOMYŚLNE
Jednostka miary	R1	U	OFF
Zarządzanie przekaźnikiem alarmowym	CFJ1	U	0
Przywracanie parametrów domyślnych	DEF	U	OFF
Włączanie/wyłączanie zdalne	R7	U	0
Wersja oprogramowania	UER	U	1.7.0
Adres urządzenia	CF30	U	1
Szybkość transmisji danych	CF31	U	5
Protokół Modbus	CF32	U	1
Włączanie/wyłączanie układu nadzoru	SUP	U	OFF
Włączenie dynamicznej nastawy	Er d	U	OFF

4.5.2 Regulacja temperatury (CFP)

PARAMETR	KOD	TYP	USTAWIENIE DOMYŚLNE
Nastawa regulacji temperatury (standardowa)	SEt	U	13.0
Nastawa regulacji temperatury (precyzyjną regulacją)	SEt	U	20.0
Różnica przy regulacji temperatury (NIE jest dostępny w konfiguracji z precyzyjną regulacją)	dIF1	U	4.0

4.5.3 Parametry konserwacji (fnt)

PARAMETR	KOD	TYP	USTAWIENIE DOMYŚLNE
Godziny pracy urządzenia	UH	U	-
Godziny pracy urządzenia (x 1000)	UHL	U	-
Godziny częściowej pracy urządzenia	UPH	U	-
Godziny częściowej pracy urządzenia (x 1000)	UPL	U	-
Godziny pracy sprężarki 1	EH	U	-
Godziny pracy sprężarki 1 (x 1000)	EHL	U	-

4.5.4 Parametry sondy (bt 1, bt 2)

Sonda (bt 1)

PARAMETR	KOD	TYP	USTAWIENIE DOMYŚLNE
Alarm dot. wysokiej temperatury (wody)	HR1	U	60

Sonda (bt 2)

PARAMETR	KOD	TYP	USTAWIENIE DOMYŚLNE
Alarm dot. wysokiej temperatury (wody)	HR2	U	60

4.5.5 Historia alarmów (ALH i)

PARAMETR	KOD	TYP	USTAWIENIE DOMYŚLNE
Numer alarmu	HYS P	U	-
Zobacz kod alarmu	HYS C	U	-
Zobacz dzień i miesiąc alarmu	HYS d	U	-
Zobacz godzinę i minuty alarmu	HYS t	U	-
Temperatura bt1 w chwili alarmu	HYS 1	U	-
Temperatura bt2 w chwili alarmu	HYS 2	U	-
USTAWIONE warunki w chwili alarmu	HYS 3	U	-

4.6 Zmiana parametrów (User)

4.6.1 Parametry agregatu chłodniczego „CF9”

Jednostka miary

<p>Włącz agregat chłodniczy za pomocą głównego włącznika QS i poczekaj aż na wyświetlaczu pojawi się słowo «OFF».</p> <p>Naciśnij jednocześnie przyciski „esc” i „set”, aby uzyskać dostęp do parametrów typu „U”.</p>	
<p>Zostaje wyświetlony parametr „PAR”.</p> <p>Naciśnij na przycisk „set”, aby wejść do menu.</p>	
<p>Zostaje wyświetlony parametr „CF9”.</p> <p>Naciśnij na przycisk „set”, aby wejść do menu.</p>	
<p>Zostaje wyświetlony parametr „A1”.</p> <p>Naciśnij na przycisk „set”, aby wejść do menu.</p>	
<p>Wartością domyślną jest „OFF” = °C.</p> <p>Za pomocą przycisków „>” i „<” wybierz jednostkę miary. OFF: temperatura = °C, stopnie Celsiusa; ciśnienie = bar; On: temperatura = °F, stopnie Fahrenheita; ciśnienie =PSI</p>	
<p>Naciśnij na przycisk „set”, aby potwierdzić.</p>	
<p>Następuje automatyczny powrót do „A1”.</p> <p>Parametr został zapisany.</p> <p>Naciśnij trzykrotnie na przycisk „esc”, aby wyjść z menu.</p>	

Zarządzanie alarmami

<p>Włącz agregat chłodniczy za pomocą głównego włącznika QS i poczekaj aż na wyświetlaczu pojawi się słowo «OFF».</p> <p>Naciśnij jednocześnie przyciski „esc” i „set”, aby uzyskać dostęp do parametrów typu „U”.</p>	
<p>Zostaje wyświetlony parametr „PAR”.</p> <p>Naciśnij na przycisk „set”, aby wejść do menu.</p>	
<p>Zostaje wyświetlony parametr „CF9”.</p> <p>Naciśnij na przycisk „set”, aby wejść do menu.</p>	
<p>Zostaje wyświetlony parametr „A1”.</p> <p>Za pomocą przycisków „>” i „<” wybierz parametr „CFJ1”.</p>	
<p>Naciśnij na przycisk „set”, aby wejść do menu.</p>	
<p>Wartością domyślną jest „0”.</p> <p>Za pomocą przycisków „>” i „<” wybierz zarządzanie przekaźnikiem alarmowym (patrz punkt 4.5.1, tab. 1).</p>	
<p>Naciśnij na przycisk „set”, aby potwierdzić.</p>	
<p>Następuje automatyczny powrót do „CFJ1”.</p> <p>Parametr został zapisany.</p> <p>Naciśnij trzykrotnie na przycisk „esc”, aby wyjść z menu.</p>	

Tab. 1: Zarządzanie przekaźnikiem alarmowym (CFJ1.)

0	Normalnie przekaźnik jest dezaktywowany, alarm powoduje jego wyzwolenie.
1	Normalnie przekaźnik jest aktywowany (również przy wyłączonym sterowaniu), alarm powoduje jego dezaktywację.
2	Normalnie przekaźnik jest aktywowany (tylko przy wyłączonym sterowaniu), alarm lub wyłączenie sterowania powoduje jego dezaktywację.

Parametry domyślne

<p>Włącz agregat chłodniczy za pomocą głównego włącznika QS i poczekaj aż na wyświetlaczu pojawi się słowo «OFF».</p> <p>Naciśnij jednocześnie przyciski „esc” i „set”, aby uzyskać dostęp do parametrów typu „U”.</p>	
<p>Zostaje wyświetlony parametr „PRr”.</p> <p>Naciśnij na przycisk „set”, aby wejść do menu.</p>	
<p>Zostaje wyświetlony parametr „CF9”.</p> <p>Naciśnij na przycisk „set”, aby wejść do menu.</p>	
<p>Zostaje wyświetlony parametr „A1”.</p> <p>Za pomocą przycisków „>” i „<” wybierz parametr „dEF”.</p>	
<p>Naciśnij na przycisk „set”, aby wejść do menu.</p>	
<p>Wartością domyślną jest «OFF».</p> <p>Za pomocą przycisków „>” i „<” przetącz pomiędzy parametrem «OFF» i „0n”.</p>	
<p>Naciśnij na przycisk „set”, aby potwierdzić.</p>	
<p>Po kilku sekundach następuje powrót do ustawienia „OFF”.</p> <p>Parametry zostały automatycznie zresetowane.</p> <p>Naciśnij trzykrotnie na przycisk „esc”, aby wyjść z menu.</p>	

ON/OFF zdalne

<p>Włącz agregat chłodniczy za pomocą głównego włącznika QS i poczekaj aż na wyświetlaczu pojawi się słowo «OFF».</p> <p>Naciśnij jednocześnie przyciski „esc” i „set”, aby uzyskać dostęp do parametrów typu „U”.</p>	
<p>Zostaje wyświetlony parametr „PRr”.</p> <p>Naciśnij na przycisk „set”, aby wejść do menu.</p>	
<p>Zostaje wyświetlony parametr „CF9”.</p> <p>Naciśnij na przycisk „set”, aby wejść do menu.</p>	
<p>Zostaje wyświetlony parametr „A1”.</p> <p>Za pomocą przycisków „>” i „<” wybierz parametr „A1”.</p>	
<p>Naciśnij na przycisk „set”, aby wejść do menu.</p>	
<p>Wartością domyślną jest „0”.</p> <p>Za pomocą przycisków „>” i „<”, wybierz tryb. (patrz punkt 4.5.1, tab. 2)</p>	
<p>Naciśnij na przycisk „set”, aby potwierdzić.</p>	
<p>Następuje automatyczny powrót do „A1”</p> <p>Parametr został zapisany.</p> <p>Naciśnij trzykrotnie na przycisk „esc”, aby wyjść z menu.</p>	

Tab. 2: Tryb zdalnego włączania/wyłączania (A1)

0	Zdalne włączanie/wyłączanie wyłączone
1	Zdalne włączanie/wyłączanie i lokalne włączanie/wyłączanie włączone. W przypadku przerwy w zasilaniu lub wyłączenia włącznika głównego zasilania po przywróceniu zasilania agregat chłodniczy należy ponownie uruchomić lokalnie.
2	Tylko zdalne włączanie/wyłączanie, lokalne włączanie/wyłączanie wyłączone

Wersja oprogramowania (tylko odczyt)

<p>Włącz agregat chłodniczy za pomocą głównego włącznika QS i poczekaj aż na wyświetlaczu pojawi się słowo «OFF».</p> <p>Naciśnij jednocześnie przyciski „esc” i „set”, aby uzyskać dostęp do parametrów typu „U”.</p>	
<p>Zostaje wyświetlony parametr „PAR”.</p> <p>Naciśnij na przycisk „set”, aby wejść do menu.</p>	
<p>Zostaje wyświetlony parametr „CF9”.</p> <p>Naciśnij na przycisk „set”, aby wejść do menu.</p>	
<p>Zostaje wyświetlony parametr „R i”.</p> <p>Za pomocą przycisków „>” i „<” wybierz parametr „UEr”.</p>	
<p>Naciśnij na przycisk „set”, aby wejść do menu.</p>	
<p>Zostaje wyświetlona wersja oprogramowania.</p>	
<p>Naciśnij trzykrotnie na przycisk „esc”, aby wyjść z menu.</p>	

Włączanie modułu nadzorowania

<p>Włącz agregat chłodniczy za pomocą głównego włącznika QS i poczekaj aż na wyświetlaczu pojawi się słowo «OFF».</p> <p>Naciśnij jednocześnie przyciski „esc” i „set”, aby uzyskać dostęp do parametrów typu „U”.</p>	
<p>Zostaje wyświetlony parametr „PAR”.</p> <p>Naciśnij na przycisk „set”, aby wejść do menu.</p>	
<p>Zostaje wyświetlony parametr „CF9”.</p> <p>Naciśnij na przycisk „set”, aby wejść do menu.</p>	
<p>Zostaje wyświetlony parametr „R i”.</p> <p>Za pomocą przycisków „>” i „<” wybierz parametr „SUP”.</p>	
<p>Naciśnij na przycisk „set”, aby wejść do menu.</p>	
<p>Wartością domyślną jest „OFF” (wyt.).</p> <p>Za pomocą przycisków „>” i „<” dokonaj zmiany.</p>	
<p>Naciśnij na przycisk „set”, aby potwierdzić.</p>	
<p>Parametr został zapisany.</p> <p>Naciśnij trzykrotnie na przycisk „esc”, aby wyjść z menu.</p>	

Modbus (adres)

<p>Włącz agregat chłodniczy za pomocą głównego włącznika QS i poczekaj aż na wyświetlaczu pojawi się słowo «OFF».</p> <p>Naciśnij jednocześnie przyciski „esc” i „set”, aby uzyskać dostęp do parametrów typu „U”.</p>	
<p>Zostaje wyświetlony parametr „PAR”.</p> <p>Naciśnij na przycisk „set”, aby wejść do menu.</p>	
<p>Zostaje wyświetlony parametr „CF9”.</p> <p>Naciśnij na przycisk „set”, aby wejść do menu.</p>	
<p>Zostaje wyświetlony parametr „A1”.</p> <p>Za pomocą przycisków „>” i „<” wybierz parametr „CF30”.</p>	
<p>Naciśnij na przycisk „set”, aby wejść do menu.</p>	
<p>Wartością domyślną jest „1”.</p> <p>Za pomocą przycisków „>” i „<” zmień adres.</p>	
<p>Naciśnij na przycisk „set”, aby potwierdzić.</p>	
<p>Parametr został zapisany.</p> <p>Naciśnij trzykrotnie na przycisk „esc”, aby wyjść z menu.</p>	

Modbus (szybkość transmisji danych)

<p>Włącz agregat chłodniczy za pomocą głównego włącznika QS i poczekaj aż na wyświetlaczu pojawi się słowo «OFF».</p> <p>Naciśnij jednocześnie przyciski „esc” i „set”, aby uzyskać dostęp do parametrów typu „U”.</p>	
<p>Zostaje wyświetlony parametr „PAR”.</p> <p>Naciśnij na przycisk „set”, aby wejść do menu.</p>	
<p>Zostaje wyświetlony parametr „CF9”.</p> <p>Naciśnij na przycisk „set”, aby wejść do menu.</p>	
<p>Zostaje wyświetlony parametr „A1”.</p> <p>Za pomocą przycisków „>” i „<” wybierz parametr „CF31”.</p>	
<p>Naciśnij na przycisk „set”, aby wejść do menu.</p>	
<p>Wartością domyślną jest „5”.</p> <p>Za pomocą przycisków „>” i „<” zmień protokół. (patrz punkt 4.5.1, tab. 3)</p>	
<p>Naciśnij na przycisk „set”, aby potwierdzić.</p>	
<p>Parametr został zapisany.</p> <p>Naciśnij trzykrotnie na przycisk „esc”, aby wyjść z menu.</p>	

Tab. 3: Szybkość transmisji danych (opcjonalnie) (CF31)

1	2400	3	9600	5	38400	7	115200
2	4800	4	19200	6	57600		

Modbus (protokół)

<p>Włącz agregat chłodniczy za pomocą głównego włącznika QS i poczekaj aż na wyświetlaczu pojawi się słowo «OFF».</p> <p>Naciśnij jednocześnie przyciski „esc” i „set”, aby uzyskać dostęp do parametrów typu „U”.</p>	
<p>Zostaje wyświetlony parametr „PAR”.</p> <p>Naciśnij na przycisk „set”, aby wejść do menu.</p>	
<p>Zostaje wyświetlony parametr „CF9”.</p> <p>Naciśnij na przycisk „set”, aby wejść do menu.</p>	
<p>Zostaje wyświetlony parametr „A1”.</p> <p>Za pomocą przycisków „>” i „<” wybierz parametr „CF32”.</p>	
<p>Naciśnij na przycisk „set”, aby wejść do menu.</p>	
<p>Wartością domyślną jest „1”.</p> <p>Za pomocą przycisków „>” i „<” zmień szybkość transmisji danych. (patrz punkt 4.5.1, tab. 4)</p>	
<p>Naciśnij na przycisk „set”, aby potwierdzić.</p>	
<p>Parametr został zapisany.</p> <p>Naciśnij trzykrotnie na przycisk „esc”, aby wyjść z menu.</p>	

Tab. 4: Protokół Modbus (opcjonalnie) (CF32)

1	EVEN	2	NONE	3	ODD
---	------	---	------	---	-----

Uwaga: Aby zastosować nowe parametry w przypadku zmiany parametrów MODBUS, należy wyłączyć agregat chłodniczy, a następnie włączyć go ponownie.

Aktywacja ERD

<p>Włącz agregat chłodniczy za pomocą głównego włącznika QS i poczekaj aż na wyświetlaczu pojawi się słowo «OFF».</p> <p>Naciśnij jednocześnie przyciski „esc” i „set”, aby uzyskać dostęp do parametrów typu „U”.</p>	
<p>Zostaje wyświetlony parametr „PAR”.</p> <p>Naciśnij na przycisk „set”, aby wejść do menu.</p>	
<p>Zostaje wyświetlony parametr „CF9”.</p> <p>Naciśnij na przycisk „set”, aby wejść do menu.</p>	
<p>Zostaje wyświetlony parametr „A1”.</p> <p>Za pomocą przycisków „>” i „<” wybierz parametr „ErD”.</p>	
<p>Naciśnij na przycisk „set”, aby wejść do menu.</p>	
<p>Wartością domyślną jest „OFF” (wyt.).</p> <p>Za pomocą przycisków „>” i „<” dokonaj zmiany.</p>	
<p>Naciśnij na przycisk „set”, aby potwierdzić.</p>	
<p>Parametr został zapisany.</p> <p>Naciśnij trzykrotnie na przycisk „esc”, aby wyjść z menu.</p>	

Przy aktywacji parametru ERD: Nastawa temperatury wody zmienia się w zależności od temperatury otoczenia. Ta funkcja jest aktywna tylko przy dezaktywacji funkcji precyzyjnej regulacji temperatury (CPT = OFF).

4.6.2 Regulacja temperatury „CNP”

Ustawienie regulacji temperatury

<p>Włącz agregat chłodniczy za pomocą głównego włącznika QS i poczekaj aż na wyświetlaczu pojawi się słowo «OFF».</p> <p>Naciśnij jednocześnie przyciski „esc” i „set”, aby uzyskać dostęp do parametrów typu „U”.</p>	
<p>Zostaje wyświetlony parametr „PAR”.</p> <p>Naciśnij na przycisk „set”, aby wejść do menu.</p>	
<p>Zostaje wyświetlony parametr „CF9”.</p> <p>Za pomocą przycisków „>” i „<” wybierz parametr „CNP”.</p>	
<p>Naciśnij na przycisk „set”, aby wejść do menu.</p>	
<p>Zostaje wyświetlony parametr „SEt”.</p> <p>Naciśnij na przycisk „set”, aby wejść do menu.</p>	
<p>Wartością domyślną jest „13.0”.</p> <p>Za pomocą przycisków „>” i „<” zmień wartość.</p>	
<p>Naciśnij na przycisk „set”, aby potwierdzić.</p>	
<p>Parametr został zapisany.</p> <p>Naciśnij trzykrotnie na przycisk „esc”, aby wyjść z menu.</p>	

Ważne: Ustawienie temperatury pomiędzy 1°C a 5°C musi wykonać specjalistyczny technik przy użyciu instrukcji serwisowej dla produktu.

Regulacja różnicy temperatur

<p>Włącz agregat chłodniczy za pomocą głównego włącznika QS i poczekaj aż na wyświetlaczu pojawi się słowo «OFF».</p> <p>Naciśnij jednocześnie przyciski „esc” i „set”, aby uzyskać dostęp do parametrów typu „U”.</p>	
<p>Zostaje wyświetlony parametr „PAR”.</p> <p>Naciśnij na przycisk „set”, aby wejść do menu.</p>	
<p>Zostaje wyświetlony parametr „CF9”.</p> <p>Za pomocą przycisków „>” i „<” wybierz parametr „CNP”.</p>	
<p>Naciśnij na przycisk „set”, aby wejść do menu.</p>	
<p>Zostaje wyświetlony parametr „SEt”.</p> <p>Za pomocą przycisków „>” i „<” wybierz parametr „d i F I”.</p>	
<p>Naciśnij na przycisk „set”, aby wejść do menu.</p>	
<p>Wartością domyślną jest „4.0”.</p> <p>Za pomocą przycisków „>” i „<” zmień wartość.</p>	
<p>Naciśnij na przycisk „set”, aby potwierdzić.</p>	
<p>Parametr został zapisany.</p> <p>Naciśnij trzykrotnie na przycisk „esc”, aby wyjść z menu.</p>	

4.6.3 Parametry sondy „bt 1”

Sonda „bt 1”.

<p>Włącz agregat chłodniczy za pomocą głównego włącznika QS i poczekaj aż na wyświetlaczu pojawi się słowo «OFF».</p> <p>Naciśnij jednocześnie przyciski „esc” i „set”, aby uzyskać dostęp do parametrów typu „U”.</p>	
<p>Zostaje wyświetlony parametr „PAR”.</p> <p>Naciśnij na przycisk „set”, aby wejść do menu.</p>	
<p>Zostaje wyświetlony parametr „CF9”.</p> <p>Za pomocą przycisków „<” i „>” wybierz parametr „bt 1”.</p>	
<p>Naciśnij na przycisk „set”, aby wejść do menu.</p>	
<p>Zostaje wyświetlony parametr „HA 1”.</p> <p>Naciśnij na przycisk „set”, aby wejść do menu.</p>	
<p>Wartością domyślną jest „60.0”.</p> <p>Za pomocą przycisków „<” i „>” zmień wartość.</p>	
<p>Naciśnij na przycisk „set”, aby potwierdzić.</p>	
<p>Parametr został zapisany.</p> <p>Naciśnij trzykrotnie na przycisk „esc”, aby wyjść z menu.</p>	

Taka sama sekwencja czynności jak w przypadku sondy „bt2”.

4.7 Wyświetlenie sonda/ wentylator/ kompresor

<p>Agregat chłodniczy jest włączony</p> <p>Naciśnij na przycisk „>”, aby wyświetlić sondy bt 1, bt 2, bt 3, bP 1.....</p>	
<p>Wybierz sondę i poczekaj kilka sekund. (np. BT2)</p>	
<p>Zostaje wyświetlona wartość z sondy bt2.</p>	
<p>Zalecamy, aby zawsze powracać do sondy bt1.</p>	

Opis:

- bt 1 : sonda temperatury wody na wyjściu
- bt 2 : sonda temperatury parownika
- bt 3 : sonda temperatury otoczenia
- bt 10 : sonda temperatury panelu elektrycznego (opcja)
- bP 1 : nadajnik obwodu 1
- bP 2 : nadajnik obwodu 2; (z modelu ICEP080)

















F... : praca wentylatora:

- F... : wentylator wyłączony
- F- : wentylator 1 włączony, wentylator 2,3 wyłączony: (2 = z modelu ICEP022) (3 = z modelu ICEP080)
- F-- : wentylator 1 i 2 włączony, wentylator 3 wyłączony, (2 = z modelu ICEP022) (3 = z modelu ICEP080)
- F--- : wentylator 1,2 i 3 włączony (z modelu ICEP080)

[-] : obsługa sprężarek:

- [-] : wyłączone sprężarki
- [-] : sprężarki wyłączone
- [-] : kompresor 1 włączony, kompresor 2 wyłączony
- [-] : sprężarki 1 i 2 włączony; (z modelu ICEP055)
- [-] : z migającą ikoną „1” sprężarka gotowa do uruchomienia, kompresor 2 wyłączony

4.8 Ustawianie zegara/daty

<p>Włącz agregat chłodniczy za pomocą głównego włącznika QS i poczekaj aż na wyświetlaczu pojawi się słowo «OFF».</p> <p>Naciśnij jednocześnie przyciski „” i „”, aby wejść do menu do menu „Data/godzina”.</p>	
<p>Zostaje wyświetlony parametr „FrEE”.</p> <p>Naciśnij na przycisk „set”, aby wejść do menu.</p>	
<p>Zostaje wyświetlony parametr „R1”.</p> <p>Za pomocą przycisków „” i „” wybierz parametr „CL”.</p>	
<p>Naciśnij na przycisk „set”, aby wejść do menu.</p>	
<p>Zostaje wyświetlony parametr „HOUr”.</p> <p>Naciśnij i przytrzymaj przez 5 sekund przycisk „set”. Parametr pulsuje.</p>	
<p>Za pomocą przycisków „” i „” wybierz zmienianą datę, godzinę lub rok.</p>	
<p>Naciśnij na przycisk „set”, aby wejść do menu.</p>	
<p>Za pomocą przycisków „” i „” zmień wartość (np. rok).</p>	
<p>Naciśnij na przycisk „set”, aby potwierdzić.</p>	

Za pomocą przycisków „” i „” zmień kolejną wartość (np. data).



Aby wyjść z menu, naciśnij przycisk „esc”. Parametr przestał pulsować.









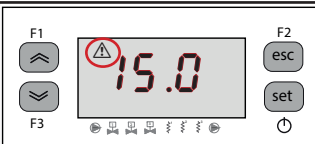

Aby wyjść z menu, naciśnij równocześnie przyciski „” i „”.



⚠ Maksymalna trwałość „zegara/daty” wynosi trzy dni, więc w przypadku pozostawienia sterownika bez zasilania przez ponad trzy dni dochodzi do utraty ustawień godziny/miesiąca/roku. Wyregulować zegar przy uruchamianiu maszyny i za każdym razem, gdy zachodzi taka potrzeba.





4.9 Zarządzanie alarmami

<p>W przypadku sygnalizowania alarmu zostaje wyświetlony kod i symbol alarmu u góry z lewej strony.</p> <p> Świeci się światłem ciągłym = występuje alarm Pulsuje = występuje ostrzeżenie/alarm, który można skwitować</p>	
Naciśnij na przycisk „set”, aby wejść do menu.	
Zostaje wyświetlony parametr „ALH 1”.	
Naciśnij na przycisk „set”, aby wejść do menu.	
Zostaje wyświetlony kod alarmu, np. „Er04”.	
Naciśnij na przycisk „up”, aby sprawdzić, czy nie występuje więcej alarmów.	
Przed zresetowaniem usuń usterkę. Po usunięciu usterki, symbol alarmu zaczyna pulsować. Teraz można zresetować urządzenie.	
Naciśnij na przycisk „esc”, aż do zniknięcia alarmu.	

Lista alarmów/ostrzeżeń

Kod	Opis	Działanie	Reset
Er01	Czujnik bt1 odłączony lub uszkodzony	Kod	M
Er02	Czujnik bt2 odłączony lub uszkodzony	Kod	M
Er03	Czujnik bt3 odłączony lub uszkodzony	Kod	A
Er05	Czujnik bt10 odłączony lub uszkodzony	Kod	A
Er06	Czujnik bP1 odłączony lub uszkodzony	Kod	M
Er08	Obwód presostatu wysokiego ciśnienia 1	Kod	M
Er09	Obwód presostatu niskiego ciśnienia 1	Kod	M
Er12	Wysoka temperatura bt1	Kod	M
Er13	Niska temperatura bt1	Kod	A
Er14	Wysoka temperatura bt2	Kod	M
Er15	Niska temperatura bt2	Kod	M
Er16	Wysoka temperatura bt3	Kod	A
Er17	Niska temperatura bt3	Kod	A
Er18	Zabezpieczenie termiczne sprężarki 1	Kod	M
Er20	Zabezpieczenie termiczne pompy 1	Kod	M
Er22	Nisko poziom wody / przetłącznik różnicowy ciśnienia	Kod	M
Er23	Monitor faz	Kod	M
Er24	Przedłużka uszkodzona lub odłączona	Kod	M
Er25	Przekroczono limit godzin pracy sprężarki 1	Ostrzeżenie	M
Er27	Przekroczono limit godzin pracy urządzenia	Ostrzeżenie	M
Er28	Pamięć zegara	Ostrzeżenie	A
Er29	Konfiguracja agregatu chłodniczego	Ostrzeżenie	A





4.10 Historia alarmów

<p>Agregat chłodniczy jest włączony. Naciśnij na przycisk „set”, aby wyświetlić historię alarmów.</p>	
<p>Naciśnij na przycisk „set”, aby wejść do menu.</p>	
<p>Za pomocą przycisków „>” i „<” wyświetl parametry. (patrz punkt 4.5.5)</p>	
<p>Naciśnij na przycisk „set”, aby wyświetlić wartość.</p>	

5 Konserwacja

- Maszyna jest zaprojektowana i skonstruowana do pracy ciągłej; trwałość jej komponentów jest zatem bezpośrednio związana z konserwacją jakiej są poddawane.
-  W przypadku zapotrzebowania na serwis lub części zamienne zidentyfikować maszynę (model i numer seryjny), odczytując dane z tabliczki identyfikacyjnej na zewnątrz jednostki. (www.polewr.com.)

5.1 Uwagi ogólne

-  Przed przystąpieniem do konserwacji urządzenia sprawdzić, czy chłodziarka nie jest podłączona do sieci.
-  Zawsze stosować oryginalne części zamienne producenta: pod groźbą zwolnienia producenta z wszelkiej odpowiedzialności za nieprawidłowe funkcjonowanie maszyny.
-  W przypadku wycieku czynnika chłodniczego skontaktować się z upoważnionym fachowcem..
-  Zaworu Schradera można używać tylko w przypadku nieprawidłowego funkcjonowania maszyny: w przeciwnym przypadku szkody spowodowane nieprawidłowym ładunkiem czynnika chłodniczego nie będą uwzględnione przez gwarancję.

5.2 Czynniki chłodnicze

Ładunek: ewentualne szkody spowodowane nieprawidłowym ładunkiem, wykonanym przez













nieupoważniony personel, nie będą uwzględnione przez gwarancję. 

-  Aparatura zawiera fluorowane gazy cieplarniane.
Płyn chłodniczy R513A przy normalnej temperaturze i ciśnieniu jest gazem bezbarwnym należącym do SAFETY GROUP A1 - EN378 (ciecz grupy 2 według dyrektywy PED 2014/68/UE); GWP (Global Warming Potential) = 629.

-  W razie wycieku czynnika chłodniczego przewietrzyć pomieszczenie.

5.3 Program konserwacji prewencyjnej

Aby zapewnić długotrwałą i maksymalną wydajność chłodziarki należy kontrolować:

Opis czynności konserwacji	Częstotliwość konserwacji (w standardowych warunkach pracy)				
	Czynność	Codziennie	Co 6 miesięcy	Co 12 miesięcy	Co 36 miesięcy
sprawdzić  serwis 					
Sprawdzić, czy kontrolka zasilania (POWER ON) jest włączona.					
Sprawdzić wskaźniki na panelu sterowania.					
Oczyścić żeberka kondensatora.					
Sprawdź wchłanianie elektryczne.					
Sprawdzić wycieki płynu chłodzącego.					
Sprawdzić i Oczyszczyć Zawór bezpieczeństwa wodą (jeśli występuje)*					
Sprawdzić układ elektryczny oraz rozdzielnicę elektryczną.**					
Sprawdzić sondy temperatury. Wymienić w razie konieczności.				 	
Zestaw do konserwacji					



Dostępne są (patrz paragraf 7.):

- Zestawy serwisowe: electrical kit; zestawy sprężarki; zestawy wentylatora; zestawy evaporator; zestawy pompa; zestawy zbiornik wody;
- indywidualne części zamienne.

*Aby zapewnić pełną wydajność, należy okresowo sprawdzać zawory bezpieczeństwa.

W miarę upływu czasu w pobliżu korka mogą osadzać się zanieczyszczenia; dlatego konieczne jest okresowe płukanie gniazda. Płukanie takie następuje po ręcznym opróżnieniu zaworu poprzez przekręcenie pokrętki w kierunku wskazywanym strzałkami.

Ważne: należy się upewnić, że przywrócono ciśnienie robocze po wykonaniu tej operacji.

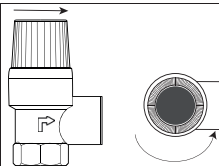



** Podczas okresowej konserwacji należy również sprawdzić układ elektryczny urządzenia oraz rozdzielnicę elektryczną zgodnie z obowiązującymi przepisami lokalnymi. Dodatkowo, zawsze gdy

jest to możliwe, należy dokonać oględzin urządzenia i przewodów elektrycznych, a także sprawdzić, czy zaciski komponentów zasilających zostały dokręcone poprawnie, właściwymi momentami dokręcania określonymi na schemacie elektrycznym.

5.4 Demontaż

Płyn chłodniczy i olej do smarowania zawarte w obwodzie należy usuwać zgodnie z obowiązującymi lokalnymi normami z zakresu ochrony środowiska.

Odzysk chłodziwa ciekłego następuje przed utylizacją końcową urządzenia ((UE) Nr. 517/2014 art.8).

	RECYCKLING DEMONTAŻI 
konstrukcja	stal/żywice epoksydowo-poliestrowe
zbiornik	aluminium/miedź/stal
rury/kolektory	miedź/aluminium/stal węglowa
izolacja rur	guma nitylowa (NBR)
sprężarka	stal/miedź/aluminium/olej
kondensator	stal/miedź/aluminium
pompa	stal/żeliwo/mosiądz
wentylator	aluminium
czynnik chłodniczy	R513A
zawory	mosiądz/miedź
kable elektryczne	miedź/PCV

Sprzęt zawierający elementy elektryczne należy utylizować oddzielnie wraz z odpadami elektrycznymi i elektronicznymi, zgodnie z lokalnymi i aktualnie obowiązującymi przepisami.



6 Wyszukiwanie usterek

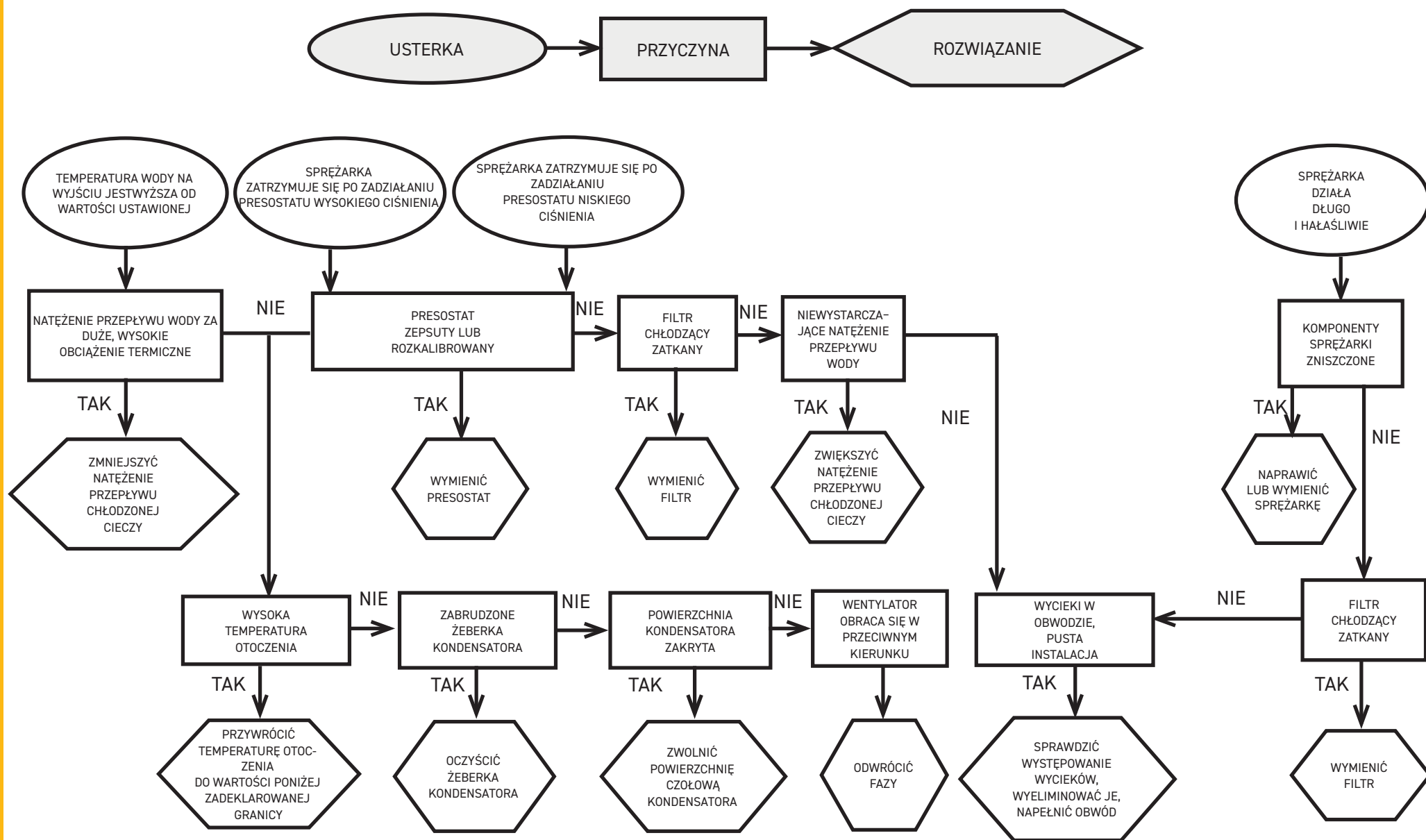

1 Bezpečnostní upozornění	2
1.1 Význam příručky.....	2
1.2 Výstražné signály.....	2
1.3 Bezpečnostní pokyny.....	2
1.4 Zbytková rizika.....	2
2 Úvod	3
2.1 Doprava.....	3
2.2 Manipulace.....	3
2.3 Kontrola.....	3
2.4 Skladování.....	3
3 Instalace	3
3.1 Provozní prostor.....	3
3.2 Verze.....	3
3.3 Vodní okruh.....	3
3.3.1 Kontroly a připojení.....	3
3.3.2 Voda a etylenglykol.....	4
3.3.3 Expanzní nádoba.....	4
3.4 Elektrický obvod.....	5
3.4.1 Kontroly a připojení.....	5
3.4.2 Obecný poplach.....	5
3.4.3 Dálkové zapínání a vypínání.....	5
3.5 Vodou chlazená verze (W).....	5
4 Ovládání	6
4.1 Ovládací panel.....	6
4.2 Význam symbolů.....	6
4.3 Jak spustit chladič.....	6
4.3.1 Nastavení a uvedení do provozu.....	6
4.3.2 Začínáme s vodou o vysoké teplotě.....	6
4.4 Jak chladič vypnout.....	7
4.5 Nastavení parametrů.....	7
4.5.1 Parametry chladiče (CF9).....	7
4.5.2 Regulace teploty (CIP).....	7
4.5.3 Parametry údržby (Fnt).....	7
4.5.4 Parametry sondy (b1, b2).....	7
4.5.5 Historie alarmů (RLH).....	7
4.6 Změnit parametry (User).....	8
4.6.1 Parametry chladiče "CF9".....	8
4.6.2 Regulace teploty "CIP".....	13
4.6.3 Parametr sondy „b1“.....	14
4.7 Zobrazení sonda/ ventilátor/ Kompresor.....	14
4.8 Nastavení hodin/ data.....	15
4.9 Řízení alarmu.....	16
4.10 Historie alarmů.....	17
5 Údržba	18
5.1 Všeobecné pokyny.....	18
5.2 Chladivo.....	18
5.3 Program preventivní údržby.....	18
5.4 Demontáž.....	19

7 Příloha

7.1 Vysvětlivky
7.2 Schéma instalace
7.3 Manipulace - Provozní prostor
7.4 Technické údaje
7.5 Rozměry
7.6 Seznam náhradních dílů
7.7 Rozpracované výkresy
7.8 Schéma okruhu
7.9 Elektrické schéma

1 Bezpečnostní upozornění

1.1 Význam příručky

- Tuto příručku uchovávejte po celou dobu životnosti stroje.
- Přečtěte si ji prosím před provedení jakéhokoli postupu.
- V příručce může dojít k úpravám. Aktualizované údaje najdete podle označení verze na zařízení.

1.2 Výstražné signály



Pokyny k ochraně osob před zraněním.



Pokyny k ochraně zařízení před poškozením.





Je nutné zavolat kvalifikovaného nebo pověřeného technika.



Význam těchto symbolů je uveden v části 7.

1.3 Bezpečnostní pokyny

 Každá jednotka je vybavena elektrickým vypínačem k zajištění bezpečného provozu. V zájmu bezpečnosti před každou údržbou zařízení tímto vypínačem odpojte.

 Příručka je určena pro koncového uživatele, který navíc smí provádět jen úkony při zavřených krytech. Úkony instalace/vedení do provozu/údržba, které vyžadují otevření krytů pomocí nástrojů, smí provádět pouze zkušený a kvalifikovaný technik.

 Pouze k instalaci v místech nepřístupných široké veřejnosti, a to buď v zabezpečeném místě s omezeným přístupem, nebo ve výšce nejméně 2,5 m, nebo v zabezpečených střešních prostorách, pokud nejsou pod dohledem nebo instruktážem ohledně používání spotřebiče osobou odpovědnou za jejich bezpečnost

 Montážní vzdálenost od zdi a volný provozní prostor jsou uvedeny na odst. 7.3.

 Pozor: Dodržujte min./max. teplotu a tlak uvedené v odst. 7.4 a celkový rozsah provozních teplot uvedený v odst. 7.2.

 Všechny jednotky by mohly být instalovány venku.

 Připojení k síti musí být provedeno v souladu s příslušnými předpisy platnými v dané zemi.

 Nepřekračujte konstrukční limity uvedené na typovém štítku.



Je povinností uživatele zabránit takovému zatížení, které je jiné než vnitřní statický tlak. Zařízení je nutné náležitým způsobem chránit před seismickými jevy, pokud takové nebezpečí hrozí. Jednotku používejte jen pro profesionální práci a k určenému účelu.



Uživatel je zodpovědný za analýzu všech aspektů použití při instalaci výrobku, za dodržení všech příslušných průmyslových a bezpečnostních norem a předpisů uvedených v této příručce k výrobku nebo v jiné dokumentaci dodané s jednotkou.

Neodborné zásahy, úprava nebo výměna jakýchkoli částí neoprávněnými pracovníky a/nebo nesprávné použití zprošťuje výrobce veškeré odpovědnosti a ruší platnost záruky.

Výrobce odmítá současnou i budoucí odpovědnost za zranění osob a poškození věcí a stroje zaviněné nedbalostí obsluhy, nedodržením všech pokynů uvedených v této příručce a platných předpisů, které se týkají bezpečnosti systému.

Výrobce odmítá jakoukoli odpovědnost za škody způsobené poškozením anebo úpravami balení.

Je odpovědností uživatele zajistit, aby specifikace poskytnuté pro výběr jednotky, dílů a/nebo funkcí plně odpovídaly správnému nebo předvídatelnému použití samotného stroje nebo jeho součástí.



DŮLEŽITÉ UPOZORNĚNÍ: Výrobce si kdykoli vyhrazuje právo na změnu této příručky.

K zajištění nejúplnějších a nejaktuálnějších informací doporučujeme používat příručku dodanou s jednotkou.

1.4 Zbytková rizika

Instalace, uvedení do provozu, zastavení a údržba stroje se musí provádět v souladu s informacemi a pokyny uvedenými v dodané technické dokumentaci a vždy takovým způsobem, aby se zabránilo vzniku nebezpečné situace.

Rizika, která nebylo možné odstranit ve fázi projektu, jsou uvedena v následující tabulce.

dotyčný díl	zbytkové riziko	způsob vystavení riziku	bezpečnostní opatření
cívka výměníku tepla	drobná poranění	dotyk	nedotýkejte se, noste ochranné rukavice
mřížka ventilátoru a ventilátor	poranění	zasunutí špičatých předmětů přes mřížku při provozu ventilátoru	do mřížky ventilátoru nezasunujte žádné předměty, ani na mřížku nic nepokládejte
uvnitř zařízení: kompresor a výtlačné potrubí	popáleniny	dotyk	nedotýkejte se, noste ochranné rukavice
uvnitř zařízení: kovové části a elektrické dráty	otrava, úraz elektrickým proudem, vážné popáleniny	vady v izolaci napájecích vedení před elektrickým panelem; kovové díly pod napětím	odpovídající elektrická ochrana napájecího vedení; zajištění správného připojení kovových dílů k uzemnění

dotyčný díl	zbytkové riziko	způsob vystavení riziku	bezpečnostní opatření
mimo zařízení: bezprostřední okolí zařízení	otrava, těžké popáleniny	požár z důvodu zkratu nebo přehřátí síťového vedení před elektrickým panelem jednotky	zajistit dodržení platných předpisů pro průřez kabelu a systém ochrany síťového vedení

2 Úvod

Motory ventilátoru, čerpadla a kompresoru jsou vybaveny tepelnou pojistkou, která je chrání před možným přehřátím.

2.1 Doprava

Zabalená jednotka musí být:

- ve svislé poloze;
- chráněná proti povětrnostním vlivům;
- chráněná před nárazy.

2.2 Manipulace

Použijte vysokozdvizný vozík vhodný pro zvedanou hmotnost a dbejte na to, aby nedošlo k žádnému nárazu.

2.3 Kontrola

- Všechny jednotky jsou smontovány, vybaveny kabeláží, naplněny chladivem a olejem a otestovány v továrně.
- Po obdržení stroje je nutné zkontrolovat jeho stav, případná poškození okamžitě oznamte dopravní společnosti.
- Zařízení vybalte co nejbližší místu instalace.

2.4 Skladování

- Zařízení skladujte zabalené na čistém místě chráněném před vlhkostí a špatným počasím.
- Zařízení neskládejte na sebe.
- Řiďte se pokyny na obalu.

3 Instalace

 K zajištění správné instalace dodržujte pokyny uvedené v odstavcích 7.

 Instalovaný produkt musí být vhodně chráněn proti riziku požáru (viz EN378-3).

 **Doporučuje se, aby všechny chladiče byly na přítoku vody do chladiče vybaveny vhodným předfiltračním zařízením (stupeň filtrace: min.05mm; max1.0mm).**

 **Chladicí kapaliny**

Chladicí kapaliny musí odpovídat použitým materiálům.

Mezi užívané kapaliny patří voda nebo roztoky **vody a etylénu nebo propylenglykolů nebo oleje**.

Chladicí kapaliny nesmí být hořlavé.

Pokud chladicí kapalina obsahuje nebezpečné látky (např. etylén nebo propylenglykol), je nutné zachytit uniklou kapalinu, protože poškozuje životní prostředí. Při vypouštění hydraulického okruhu se řiďte platnými předpisy a obsah nevylévejte do prostředí.

3.1 Provozní prostor

 **Okolo zařízení nechte volný prostor asi 1,5 m.**

U modelů s vypouštěním kondenzačního vzduchu do výšky ponechte asi 2 metry volného místa nad chladičem.

3.2 Verze

Vzduchová verze: Axiální ventilátory (A)

Dbejte na to, aby se chladicí vzduch nevracel zpět do chladiče.

Nezakrývejte větrací otvory.

U verzí s axiálními ventilátory se nedoporučuje odsávací potrubí.

Vodou chlazená verze (W)



Pokud je voda přiváděná ke kondenzátoru v otevřeném okruhu, osadte přívod kondenzační vody sítkovým filtrem.

Pro zvláštní druhy chladicí vody, např. demineralizovanou, deionizovanou nebo destilovanou, je nutné se obrátit na výrobce a ověřit si, jaký typ kondenzátoru doporučuje, protože standardní model nemusí být vhodný.

3.3 Vodní okruh

3.3.1 Kontroly a připojení

 Před připojením chladiče a napuštěním okruhu zkontrolujte, zda jsou trubky čisté. Pokud nejsou, důkladně je propláchněte.

  **Pokud je vodovodní instalace okruhu uzavřená a pod tlakem, obsahuje pojistný ventil nastavený na: 6 barů.**

 Přívodní a odvodní potrubí vždy osadte sítkovými filtry.

 Jsou-li v hydraulickém okruhu zařazeny automatické ventily, chraňte čerpadlo systémem protirázové ochrany.

 Pokud je hydraulický okruh při odstávce zařízení vypuštěn, doporučujeme přidat do rotoru čerpadla mazací kapalinu, aby se čerpadlo při novém spuštění nezablokovalo. Pokud je rotor zablokován, je nutné ho odblokovat ručně.

Sejměte zadní kryt čerpadla a opatrně pootočte plastovým ventilátorem. Pokud je rotor zaseknutý, sejměte ventilátor pootočte hřídeli rotoru přímo. Po odblokování rotoru ventilátor a kryt znovu nasadíte.

Předběžné kontroly

1. Zkontrolujte, zda jsou zavírací ventily v hydraulickém okruhu otevřené.
2. U uzavřeného vodního okruhu zkontrolujte, zda byla nainstalována expanzní nádrž o přiměřeném objemu.

Připojení

1. S použitím speciálních přípojek umístěných na zadní straně zařízení připojte chladič k přítokovému a odtokovému potrubí.
K omezení rigidity systému doporučujeme použít ohebné spoje.
2. Naplňte vodní okruh pomocí armatury připravené na zadní stěně chladiče () .
3. Nádrž je vybavena odvodušňovacím ventilem, který je při napouštění nádrže nutné ovládat ručně. Jsou-li v hydraulickém obvodu vyvýšená místa, nainstalujte odvodušňovací ventily právě tam.
4. Doporučujeme přítokové a odtokové potrubí osadit kohouty, aby v případě potřeby bylo možné zařízení odpojit.
5. Pokud chladič pracuje s otevřenou nádrží, čerpadlo je nutné nainstalovat na přívodu do nádrže a na přívodu do čerpadla.



Varování (modely 022-120): stroj je vybaven automatickým ochranným zařízením pro nádrž. Pokud je přívod vody neúmyslně uzavřen, když je čerpadlo spuštěno a výstup vody je otevřený, vzduch vstoupí do nádrže s pravděpodobným zásahem snímače hladiny. Pro odstranění vzduchu bude nutné odvzdušnit hydraulický okruh.

Další kontroly

1. Zkontrolujte, zda nádrž a vodní okruh jsou zcela napuštěné vodou a že ze systému byl vytlačen všechen vzduch.
2. Vodní okruh musí být vždy zcela napuštěný. Proto provádějte pravidelné kontroly a okruh podle potřeby doplňujte, nebo nainstalujte automatické napouštěcí zařízení.

Vlastnosti vodní

Pokud není síťový filtr již instalován, instalujte ho na vodní.



Vlastnosti vodní:

Teplota	≥50°F (10°C)	CL ⁻	<50 ppm
ΔT IN/OUT	5-15°C	CaCO ₃	70-150 ppm
Max % glykolu	50	O ₂	<0.1 ppm
Tlak	43.5-145 PSig (3-10 barg)	Fe	<0.2 ppm
PH	7.5-9	NO ₃	<2 ppm
Měrná elektrická vodivost	10-500 μS/cm	HCO ₃ ⁻	70-300 ppm
Langelierův index nasycení	0-1	H ₂ S	<0.05 ppm
SO ₄ ²⁻	<50 ppm	CO ₂	<5 ppm
NH ₃	<1 ppm	Al	<0.2 ppm

Standard materiály určené pro mohly být nevhodné u speciálních druhů chladící vody (ionizovaná, destilovaná, demineralizovaná). V těchto případech je třeba kontaktovat výrobce.

3.3.2 Voda a etylenglykol

Pokud bylo zařízení nainstalováno venku nebo v nevytápěném interiéru a systém není v nejméně chladnějších částech roku v provozu, voda může v obvodu zmrznout.

Pro snížení tohoto nebezpečí:

- Vyberte chladič vhodnými doplňky proti zamrznání, které si lze objednat u výrobce jako volitelné příslušenství.
- Pokud má být systém odstaven na delší dobu, vypusťte z něj vodu pomocí odtokového ventilu.
- Do vody v obvodu přidejte odpovídající objem nemrzoucí kapaliny (viz tabulka).

Teplota vypouštěné [°C]	Etylenglykol (% objemu)	Teplota prostředí
4	5	-2
2	10	-5
0	15	-7
-2	20	-10
-4	25	-12
-6	30	-15
-10	40	-20

3.3.3 Expanzní nádoba

Abyste zabránili možnosti zvýšení nebo snížení objemu kapaliny v důsledku výrazné změny její teploty a následnému poškození zařízení nebo vodního obvodu, doporučujeme nainstalovat expanzní nádobu odpovídajícího objemu.

Expanzní nádobu je nutné nainstalovat na přívodu do čerpadla na zadní přípojce nádrže.

Minimální objem expanzní nádoby instalované na uzavřený okruh se vypočte podle tohoto vzorce:

$$V = 2 \times V_{tot} \times (P_{t \min} - P_{t \max})$$

kde

V_{tot} = celkový objem okruhu (v litrech)

$P_{t \min}/P_{t \max}$ = specifická váha při vody při minimální/maximální dosažené teplotě vody [kg/dm³].

Tabulka obsahuje hodnoty specifické váhy při různých teplotách pro různá procenta glykolu.

% glykolu	Teplota [°C]						
	-10	0	10	20	30	40	50
0%	1.0024	1.0008	0.9988	0.9964	0.9936	0.9905	0.9869
10%	1.0177	1.0155	1.0130	1.0101	1.0067	1.0030	0.9989
20%	1.0330	1.0303	1.0272	1.0237	1.0199	1.0156	1.0110
30%	1.0483	1.0450	1.0414	1.0374	1.0330	1.0282	1.0230
40%	1.0636	1.0594	1.0525	1.0511	1.0461	1.0408	1.0350



Pozor! Při napouštění systému je třeba počítat i s objemem expanzní nádoby.

Pokud je teplota okolního vzduchu v chladiči nižší než -10 °C, musíte přesunout expanzní nádrž do chráněného prostředí blízko na straně zpětného vedení vody chladiče. Pojistný ventil a vypouštěcí ventil musí zůstat na chladiči.

3.4 Elektrický obvod

3.4.1 Kontroly a připojení



Před každým zásahem do elektrického systému je nutné se ujistit, že zařízení je odpojeno od elektrického zdroje.

Připojení k síti musí být provedeno v souladu s příslušnými předpisy platnými v dané zemi.

Úvodní kontroly

1. Napětí a kmitočet zdroje musí odpovídat hodnotám uvedeným na typovém štítku chladiče. Hodnoty zdroje se ani na krátký interval nesmí odchýlit od tolerančního rozmezí uvedeného v elektrickém schématu, a sice +/- 10 % u napětí a +/- 1 % u kmitočtu.
2. Napájení musí být symetrické (hodnoty účinného napětí a fázové úhly po sobě jdoucích fází musí být totožné). Maximální přípustná nerovnováha v napětí jsou 2 %.

Připojení

1. Zdroj napájení musí být ke chladiči připojen 4žilovým kabelem s třemi fázovými a jedním uzemňovacím vodičem, bez nulového vodiče. Minimální průřezy kabelu jsou uvedeny v odst. 7.3.
2. Kabel protáhněte průvlakem v zadním panelu zařízení; fázi a nulu připojte ke koncovkám na hlavním vypínači (QS). Uzemňovací vodič připojte k uzemňovací koncovce (PE).
3. Ujistěte se, že přívodní kabel má u svého zdroje ochranu před přímým kontaktem minimálně IP2X nebo IPXXB.
4. Na přívod ke chladiči nainstalujte jistič zbytkového proudu se spouštěcí hodnotou (RCCB - IDn = 0.3A), s napětím uvedeným v elektrickém schématu a se zkratovou hodnotou odpovídající zkratovému proudu v místě instalace zařízení.
Jmenovitý vstupní proud tohoto magnetického jističe musí být roven hodnotě proudu při plné zátěži (FLA) s křivkou odezvy typu D.
5. Max. hodnota celkového odporu sítě = 0,274 ohmů.

Další kontroly

Přesvědčte se, že zařízení a pomocné příslušenství jsou uzemněné a chráněné před zkratem a/nebo přepětí.



Když se zařízení připojí a hlavní vypínač napájení zapne (čímž se zařízení připojí ke zdroji), napětí v elektrickém obvodu dosáhne nebezpečných hodnot. Je třeba maximální opatrnosti!



Je odpovědností instalačního technika provést povinné minimální testy, aby byla zajištěna správná elektrická instalace v souladu s místními předpisy a příslušným uzemňovacím systémem, včetně specifických požadavků na izolované neutrální systémy (IT).

3.4.2 Obecný poplach

Všechny chladiče jsou vybavené poplašným systémem (viz elektrické schéma), který obsahuje odpojovač na svorkovnici. Ten lze použít k připojení externí zvukové nebo světelné signalizace nebo jako zdroj signálu pro systém logiky ovládání, jako např. PLC.

3.4.3 Dálkové zapínání a vypínání

Všechny chladiče lze připojit ke vzdálenému vypínači.

- Chcete-li povolit vzdálené rif. č. 16387

- Jako referenční proměnná ON/OFF rif.n.8996

Poznámka: nepovolujte současně „Sup“ a „Re“ .

Připojení ke vzdálenému vypínači je vyznačeno na elektrickém schématu. (odst. 7.)

3.5 Vodou chlazená verze (W)

Chladiče ve vodou chlazené verzi vyžadují okruh, který přivádí ke kondenzátoru studenou vodu. Vodou chlazená verze je na vstupu kondenzátoru vybavena regulačním ventilem tlaku, jehož úkolem je regulovat průtok vody tak, aby kondenzace probíhala vždy optimálně.

Předběžné kontroly

Pokud je přítok vody ke kondenzátoru řešen uzavřeným okruhem, proveďte všechny předběžné kontroly uvedené u napájecího vodovodního okruhu (odst. 3.3.1)..





Připojení

1. Okruh s chladicí vodou se doporučuje vybavit uzavíracími ventily, aby zařízení bylo možné při údržbě odpojit.
2. S použitím speciálních přípojek umístěných na zadní straně zařízení připojte chladič k přítokovému a odtokovému potrubí.
3. Pokud se dá očekávat časté doplňování chladicí vody, doporučuje se vstup do kondenzátoru vybavit filtrem, aby se snížilo riziko znečištění povrchů.
4. Je-li obvod uzavřeného typu, dbejte na to, aby byl naplněn vodou a řádně odvzdušněn.

















4 Ovládání

4.1 Ovládací panel



-  Tlačítko NAHORU: stiskněte pro zvýšení hodnoty vybraného upravitelného parametru.
-  Tlačítko DOLŮ: stiskněte pro snížení hodnoty vybraného upravitelného parametru.
-  Tlačítko ESC: ukončení bez uložení; návrat na předchozí úroveň; **STISKNUTO na 5 s. RESET ALARMU.**
-  Tlačítko SET: pro ukončení a uložení/ potvrzení hodnoty; k přechodu na další úroveň; ke vstupu do nabídky nastavení; **STISKNUTO na 5 s. SPUŠTĚNÍ CHLADIČE**

4.2 Význam symbolů

Symbol	Stav symbolu	Funkce	Symbol	Stav symbolu	Funkce	
	Svídí	Kompresor ON		Svídí	Hodnota teploty	
	Bliká	Kompresor ve stand-by			Svídí	Hodnota tlaku
	Off	Kompresor OFF				 Svítí
	Svídí	Aktivní alarm	Off	Protimrazový ohřivač OFF		
	Bliká	Varování nebo Resetovatelný alarm		 Svítí		Ohřivač klikové skříně ON Kompresor 1
Off	Žádný alarm	Off		Ohřivač klikové skříně Off Kompresor 1		
	 Svítí	Čerpadlo 1 ON		 Svítí	Ohřivač klikové skříně ON Kompresor 2 (není)	
	Off	Čerpadlo 1 Off		Off	Ohřivač klikové skříně Off Kompresor 2 (není)	
	 Svítí	Čerpadlo 2 ON (není)		 Svítí	Ohřivač klikové skříně ON Kompresor 2 (není)	
	Off	Čerpadlo 2 Off (není)		Off	Ohřivač klikové skříně Off Kompresor 2 (není)	

4.3 Jak spustit chladič

- Připojte zařízení ke zdroji napájení přepnutím hlavního vypínače QS do polohy ON.
- Zapněte stisknutím tlačítka "set".
- Na ovladači nastavte požadovanou teplotu. (odst. 4.5.1)

Monitor fáze

Jestliže se po spuštění na displeji zobrazí poplach "E-23", uživatel musí ověřit, zda provedl správně kabeláž svorek vstupu úsekového vypínače.

4.3.1 Nastavení a uvedení do provozu

- Nastavení teploty vody v části 4.5.
- Regulace čerpadla
Ověřte správnou funkci čerpadla tlakoměrem (odečtete hodnoty P1 a P0) a kontrolou limitních hodnot tlaku (Pmax a Pmin), uvedených na identifikačním štítku čerpadla.
P1 = tlak při zapnutém čerpadlu
P0 = tlak při vypnutém čerpadlu
 $P_{min} < (P1 - P0) < P_{max}$
 - příklad č. 1.
Podmínky:
uzavřený okruh, tlak P0 = 2 bary
hodnoty na identifikačním štítku čerpadla: Pmin 1 bar / Pmax 3 bary
upravte výstup z ventilu tak, aby tlak byl 3 bary < P1 < 5 barů
 - příklad č. 2.
Podmínky:
otevřený okruh, tlak P0 = 0 bar
hodnoty na identifikačním štítku čerpadla: Pmin 1 bar / Pmax 3 bary
upravte výstup z ventilu tak, aby tlak byl 1 bar < P1 < 3 bary
- Analogicky ověřte správnou funkci čerpadla za běžných provozních podmínek.
Zkontrolujte také, zda hodnota proudu čerpadla je v rozmezí udaném na identifikačním štítku.
- Chladič vypněte a doplňte hydraulický okruh při teplotě uvedené v nastavení.
- Zkontrolujte, zda teplota doplňované vody není nižší než 5 °C a zda teplota prostředí, ve kterém hydraulický okruh funguje, neklesá pod 5 °C. Pokud je teplota příliš nízká, dolijte odpovídající objem glykolu, viz část 3.3.3.

 **POZOR!** Před zapnutím čerpadla chladiče uzavřete vypouštěcí ventil vody (jeho instalaci zajistí klient).

Napouštěcí ventil (jeho instalaci zajistí klient) ponechejte vždy otevřený.

Při zapínání čerpadla pomalu otevřete vypouštěcí ventil vody z chladiče a upravte rychlost průtoku, jak je popsáno v bodě 4.3.1.

4.3.2 Začínáme s vodou o vysoké teplotě

V případě, že je teplota vody v okruhu vysoká (například 30–35 °C), postupně uzavřete (ale ne úplně, asi do dvou třetin!) uzavírací ventil (které zajišťuje zákazník) na výstupu z chladicí jednotky, abyste snížili průtok vody jednotkou. Ventil postupně otevírejte, jakmile teplota vody klesne na provozní hodnotu.

Důležité: Za tohoto stavu se může spustit několik alarmů vysokého tlaku, které je nutné ručně resetovat.

Důležité: Toto nastavení také umožňuje zabránit vodnímu rázu v potrubí způsobenému vzduchovými kapsami v okruhu (vzduchové kapsy je nutné odstranit odvzdušňovacími ventily v nejvyšších bodech hydraulického okruhu, které zajišťuje zákazník).

4.4 Jak chladič vypnout

Pokud chladič není nutný, vypněte ho následujícím postupem: stisknutím tlačítka "set" (5 Sec.). Nevypínejte hlavní vypínač QS, aby případné zařízení na ochranu před zamrznutím zůstalo stále pod proudem.

4.5 Nastavení parametrů

Obecné pokyny

Parametry mají dvě úrovně ochrany:

- Přímou User-(U): s okamžitým přístupem, **změnitelné uživatelem**;
- Ochrana heslem Service(S): vyžadováno heslo pro přístup, **(neměňte)**.

4.5.1 Parametry chladiče (CF9)

PARAMETR	KÓD	TYP	VÝCHOZÍ HODNOTA
Měrná jednotka	R1	U	OFF
Správa alarmového relé	CFJ1	U	0
Reset výchozích parametrů	dEF	U	OFF
Povolení dálkového zapnutí/vypnutí	R7	U	0
Verze softwaru	UEr	U	1.7.0
Adresa jednotky	CF30	U	1
Přenosová rychlost	CF31	U	5
Protokol Modbus	CF32	U	1
Povolení zapnutí/vypnutí supervizora	SUP	U	OFF
Povolení dynamické požadované hodnoty	ErD	U	OFF

4.5.2 Regulace teploty (CTP)

PARAMETR	KÓD	TYP	VÝCHOZÍ HODNOTA
Nastavená hodnota řízení teploty (standardní)	SEt	U	13.0
Nastavená hodnota řízení teploty (kontrola přesnosti)	SEt	U	20.0
Regulace rozdílu teploty (NENÍ v konfiguraci „kontrola přesnosti“)	dIF1	U	4.0

4.5.3 Parametry údržby (PHt)

PARAMETR	KÓD	TYP	VÝCHOZÍ HODNOTA
Pracovní hodiny jednotky	UH	U	-
Pracovní hodiny jednotky (X1000)	UHL	U	-
Částečné pracovní hodiny jednotky	UPH	U	-
Částečné pracovní hodiny jednotky (X1000)	UPHL	U	-

PARAMETR	KÓD	TYP	VÝCHOZÍ HODNOTA
Pracovní hodiny kompresoru 1	CH	U	-
Pracovní hodiny kompresoru 1 (x1000)	CHL	U	-

4.5.4 Parametry sondy (bt 1, bt 2)

Sonda (bt 1)

PARAMETR	KÓD	TYP	VÝCHOZÍ HODNOTA
Alarm vysoké teploty (voda)	HR1	U	50

Sonda (bt 2)

PARAMETR	KÓD	TYP	VÝCHOZÍ HODNOTA
Alarm vysoké teploty (voda)	HR2	U	50

4.5.5 Historie alarmů (ALH 1)

PARAMETR	KÓD	TYP	VÝCHOZÍ HODNOTA
Číslo alarmu	HYSP	U	-
Viz číslo alarmu	HYSC	U	-
Viz den a měsíc alarmu	HYSD	U	-
Viz hodina a minuty alarmu	HYSE	U	-
Teplota bt1 v době alarmu	HY51	U	-
Teplota bt2 v době alarmu	HY52	U	-
Podmínky NASTAVENÍ v době alarmu	HY53	U	-

4.6 Změnit parametry (User)

4.6.1 Parametry chladiče "CF9"

Měrná jednotka

Zapněte chladič "ON" pomocí hlavního odpojovače QS a počkejte na zobrazení ukazatele „OFF“. Stiskněte současně tlačítka "esc" a "set" pro zadání parametrů "U".	
Zobrazí se parametr "PAR". Stiskněte tlačítko "set" k zadání.	
Zobrazí se parametr "CF9". Stiskněte tlačítko "set" k zadání.	
Zobrazí se parametr "A I". Stiskněte tlačítko "set" k zadání	
Výchozí hodnota je "OFF" = °C Použijte tlačítka "a" a "b" pro výběr měrné jednotky. OFF: teplota = °C, Celsius; tlak = bar; On: teplota = °F, Fahrenheit; Tlak = PSI	
Stiskněte tlačítko "set" k potvrzení.	
Automaticky se vrátí na „A I“ Parametr je nyní uložen. Stiskněte tlačítko "esc" pro ukončení, třikrát.	

Řízení alarmu

Zapněte chladič "ON" pomocí hlavního odpojovače QS a počkejte na zobrazení ukazatele „OFF“. Stiskněte současně tlačítka "esc" a "set" pro zadání parametrů "U".	
Zobrazí se parametr "PAR". Stiskněte tlačítko "set" k zadání.	
Zobrazí se parametr "CF9". Stiskněte tlačítko "set" k zadání.	
Zobrazí se parametr "A I". Použijte tlačítka "a" a "b" k volbě "CFJ I" parametru.	
Stiskněte tlačítko "set" k zadání.	
Výchozí hodnota je "0" Použijte tlačítka "a" a "b" k volbě řízení relé alarmu (odst. 4.5.1- Tab.1)	
Stiskněte tlačítko "set" k potvrzení.	
Automaticky se vrátí na „CFJ I“. Parametr je nyní uložen. Stiskněte tlačítko "esc" pro ukončení, třikrát.	

Tab.1 Řízení relé alarmu (CFJ I.)

0	Relé normálně deaktivováno, aktivuje se při alarmu
1	Relé normálně aktivováno (také při vypnutém ovládní), aktivuje se při alarmu.
2	Relé normálně aktivováno (pouze při zapnutém ovládní), deaktivuje se při alarmu nebo při vypnutém ovládní.

Výchozí parametry

Zapněte chladíč "ON" pomocí hlavního odpojovače QS a počkejte na zobrazení ukazatele „OFF“. Stiskněte současně tlačítka "esc" a "set" pro zadání parametrů "U".	
Zobrazí se parametr "PAR". Stiskněte tlačítko "set" k zadání.	
Zobrazí se parametr "CF9". Stiskněte tlačítko "set" k zadání.	
Zobrazí se parametr "A1". Použijte tlačítka "a" a "a" k volbě parametru "dEF".	
Stiskněte tlačítko "set" k zadání.	
Výchozí hodnota je "OFF". Použijte tlačítka "a" a "a" ke změně z "OFF" na "On".	
Stiskněte tlačítko "set" k potvrzení.	
Po několika sekundách se vraťte na „OFF“. Parametry byly automaticky resetovány. Stiskněte tlačítko "esc" k ukončení, třikrát.	







Dálkové ovládání ON/OFF

Zapněte chladíč "ON" pomocí hlavního odpojovače QS a počkejte na zobrazení ukazatele „OFF“. Stiskněte současně tlačítka "esc" a "set" pro zadání parametrů "U".	
Zobrazí se parametr "PAR". Stiskněte tlačítko "set" k zadání.	
Zobrazí se parametr "CF9". Stiskněte tlačítko "set" k zadání.	
Zobrazí se parametr "A1". Použijte tlačítka "a" a "a" k volbě parametru "A7".	
Stiskněte tlačítko "set" k zadání.	
Výchozí hodnota je "0". Použijte tlačítka "a" a "a" k volbě režimu: (odst. 4.5.1- Tab.2)	
Stiskněte tlačítko "set" k potvrzení.	
Automaticky se vrátí na „A7“. Parametr je nyní uložen. Stiskněte tlačítko "esc" pro ukončení, třikrát.	









Tab.2 Režim vzdáleného zapnutí/vypnutí (A7)

	Vzdálený vypínač deaktivován
	Vzdálené zapnutí/vypnutí povoleno spolu s místním zapnutím/vypnutím. V případě výpadku napájení nebo vypnutí hlavního vypínače se musí chladíč po obnovení napájení restartovat lokálně.
	Jen vzdálený vypínač, lokální vypínač deaktivován

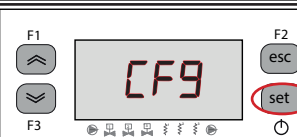







Verze softwaru (pouze ke čtení)

<p>Zapněte chladič "ON" pomocí hlavního odpojovače QS a počkejte na zobrazení ukazatele „OFF“.</p> <p>Stiskněte současně tlačítka "esc" a "set" pro zadání parametrů "U".</p>	
<p>Zobrazí se parametr "PAr".</p> <p>Stiskněte tlačítko "set" k zadání.</p>	
<p>Zobrazí se parametr "CF9".</p> <p>Stiskněte tlačítko "set" k zadání.</p>	
<p>Zobrazí se parametr "A I".</p> <p>Použijte tlačítka "down" a "up" k volbě parametru "UEr".</p>	
<p>Stiskněte tlačítko "set" k zadání.</p>	
<p>Zobrazí se verze softwaru.</p>	
<p>Stiskněte tlačítko "esc" pro ukončení, třikrát.</p>	







Povolení supervizora

<p>Zapněte chladič "ON" pomocí hlavního odpojovače QS a počkejte na zobrazení ukazatele „OFF“.</p> <p>Stiskněte současně tlačítka "esc" a "set" pro zadání parametrů "U".</p>	
<p>Zobrazí se parametr "PAr".</p> <p>Stiskněte tlačítko "set" k zadání.</p>	
<p>Zobrazí se parametr "CF9".</p> <p>Stiskněte tlačítko "set" k zadání.</p>	
<p>Zobrazí se parametr "A I".</p> <p>Použijte tlačítka "down" a "up" k volbě parametru "SUP".</p>	
<p>Stiskněte tlačítko "set" k zadání.</p>	
<p>Výchozí hodnota je "OFF".</p> <p>Použijte tlačítka "down" a "up" ke změně.</p>	
<p>Stiskněte tlačítko "set" k potvrzení.</p>	
<p>Parametr je nyní uložen.</p> <p>Stiskněte tlačítko "esc" pro ukončení, třikrát.</p>	

Modbus (adresa)

Zapněte chladič "ON" pomocí hlavního odpojovače QS a počkejte na zobrazení ukazatele „OFF“. Stiskněte současně tlačítka "esc" a "set" pro zadání parametrů "U".	
Zobrazí se parametr "PAR". Stiskněte tlačítko "set" k zadání.	
Zobrazí se parametr "CF9". Stiskněte tlačítko "set" k zadání.	
Zobrazí se parametr "A 1". Použijte tlačítka "set" a "up" k volbě parametru "CF30".	
Stiskněte tlačítko "set" k zadání.	
Výchozí hodnota je "1". Použijte tlačítka "set" a "up" ke změně adresy.	
Stiskněte tlačítko "set" k potvrzení.	
Parametr je nyní uložen. Stiskněte tlačítko "esc" pro ukončení, třikrát.	

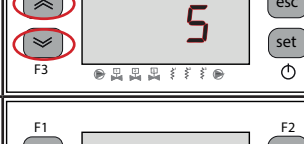





Modbus (přenosová rychlost v baudech)

Zapněte chladič "ON" pomocí hlavního odpojovače QS a počkejte na zobrazení ukazatele „OFF“. Stiskněte současně tlačítka "esc" a "set" pro zadání parametrů "U".	
Zobrazí se parametr "PAR". Stiskněte tlačítko "set" k zadání.	
Zobrazí se parametr "CF9". Stiskněte tlačítko "set" k zadání.	
Zobrazí se parametr "A 1". Použití a tlačítka "set" a "up" k volbě parametru "CF31".	
Stiskněte tlačítko "set" k zadání.	
Výchozí hodnota je "5". Použijte tlačítka "set" a "up" ke změně protokolu. (odst. 4.5.1- Tab.3)	
Stiskněte tlačítko "set" k potvrzení.	
Parametr je nyní uložen. Stiskněte tlačítko "esc" pro ukončení, třikrát.	

Tab.3 Přenosová rychlost (volitelné)(CF3 1)

1	2400	3	9600	5	38400	7	115200
2	4800	4	19200	6	57600		

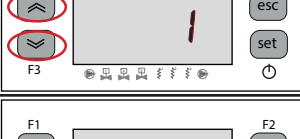
Modbus (protokol)







Zapněte chladič "ON" pomocí hlavního odpojovače QS a počkejte na zobrazení ukazatele „OFF“. Stiskněte současně tlačítka "esc" a "set" pro zadání parametrů "U".	
Zobrazí se parametr "PAr". Stiskněte tlačítko "set" k zadání.	
Zobrazí se parametr "CF9". Stiskněte tlačítko "set" k zadání.	
Zobrazí se parametr "A 1". Použijte tlačítka "a" a "a" k volbě parametru "CF32".	
Stiskněte tlačítko "set" k zadání.	
Výchozí hodnota je "1". Použijte tlačítka "a" a "a" ke změně přenosové rychlosti. (odst. 4.5.1- Tab.4)	
Stiskněte tlačítko "set" k potvrzení.	
Parametr je nyní uložen. Stiskněte tlačítko "esc" pro ukončení, třikrát.	

Tab.4 Protokol modbus (nepovinné)(CF32)

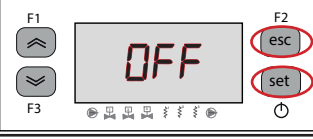
1	SUDÉ	2	ŽÁDNÉ	3	LIČÉ
---	------	---	-------	---	------

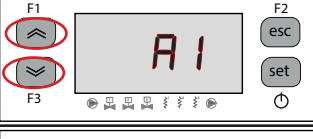
 **Poznámka:** Pokud změníte parametry MODBUS, pro ověření nových parametrů musíte vypnout chladič OFF a poté jej znovu zapnout ON.









Zpřístupnění ERD

Zapněte chladič "ON" pomocí hlavního odpojovače QS a počkejte na zobrazení ukazatele „OFF“. Stiskněte současně tlačítka "esc" a "set" pro zadání parametrů "U".	
Zobrazí se parametr "PAr". Stiskněte tlačítko "set" k zadání.	
Zobrazí se parametr "CF9". Stiskněte tlačítko "set" k zadání.	
Zobrazí se parametr "A 1". Použijte tlačítka "a" a "a" k volbě parametru "Er d".	
Stiskněte tlačítko "set" k zadání.	
Výchozí hodnota je "OFF". Použijte tlačítka "a" a "a" ke změně.	
Stiskněte tlačítko "set" k potvrzení.	
Parametr je nyní uložen. Stiskněte tlačítko "esc" pro ukončení, třikrát.	

 **S povoleným parametrem ERD: Změna nastavené teploty vody podle okolní teploty. Funkce je aktivní pouze v případě, že je deaktivována regulace teploty (CPT=OFF).**









4.6.2 Regulace teploty "CNP"

Nastavení ovladače teploty

Zapněte chladič "ON" pomocí hlavního odpojovače QS a počkejte na zobrazení ukazatele „OFF“. Stiskněte současně tlačítka "esc" a "set" pro zadání parametrů "U".	
Zobrazí se parametr "PAr". Stiskněte tlačítko "set" k zadání.	
Zobrazí se parametr "CF9". Použijte tlačítka "down" a "up" k volbě parametru "CNP".	
Stiskněte tlačítko "set" k zadání.	
Objeví se parametr "SEt". Stiskněte tlačítko "set" k zadání.	
Výchozí hodnota je "13.0". Použijte tlačítka "down" a "up" ke změně hodnoty.	
Stiskněte tlačítko "set" k potvrzení.	
Parametr je nyní uložen. Stiskněte tlačítko "esc" pro ukončení, třikrát.	















Důležité upozornění: Nastavení teplot mezi 1 °C a 5 °C musí provést specializovaní technici, kteří se musí řídit příslušnou servisní příručkou tohoto produktu.

Regulace rozdílu teploty

Zapněte chladič "ON" pomocí hlavního odpojovače QS a počkejte na zobrazení ukazatele „OFF“. Stiskněte současně tlačítka "esc" a "set" pro zadání parametrů "U".	
Zobrazí se parametr "PAr". Stiskněte tlačítko "set" k zadání.	
Zobrazí se parametr "CF9". Použijte tlačítka "down" a "up" k volbě parametru "CNP".	
Stiskněte tlačítko "set" k zadání.	
Objeví se parametr "SEt". Použijte tlačítka "down" a "up" k volbě parametru "d iF l".	
Stiskněte tlačítko "set" k zadání.	
Výchozí hodnota je "4.0". Použijte tlačítka "down" a "up" ke změně hodnoty.	
Stiskněte tlačítko "set" k potvrzení.	
Parametr je nyní uložen. Stiskněte tlačítko "esc" pro ukončení, třikrát.	





4.6.3 Parametr sondy „bt 1“

Sonda „bt 1“.

Zapněte chladič "ON" pomocí hlavního odpojovače QS a počkejte na zobrazení ukazatele „OFF“.	
Stiskněte současně tlačítka "esc" a "set" pro zadání parametrů "U".	
Zobrazí se parametr "PAr".	
Stiskněte tlačítko "set" k zadání.	
Zobrazí se parametr "CF9".	
Použijte tlačítka "↓" a "↑" k volbě parametru "bt 1".	
Stiskněte tlačítko "set" k zadání.	
Objeví se parametr "HA 1".	
Stiskněte tlačítko "set" k zadání.	
Výchozí hodnota je "60.0".	
Použijte tlačítka "↓" a "↑" ke změně hodnoty.	
Stiskněte tlačítko "set" k potvrzení.	
Stiskněte tlačítko "set" k potvrzení.	
Parametr je nyní uložen.	
Stiskněte tlačítko "esc" pro ukončení, třikrát.	

Stejná sekvence pro sondu "bt2".

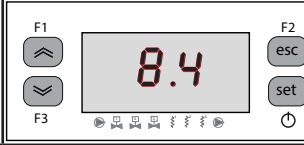
4.7 Zobrazení sonda/ ventilátor/ Kompresor

Chladič v provozu.	
Stiskněte tlačítko "↑" pro zobrazení sond bt 1, bt 2, bt 3, bP 1.....	
Vyberte sondu a počkejte několik sekund. (Např. BT2)	
Zobrazí se hodnota sondy bt 2.	
Je vhodné se vždy vrátit k sondě bt 1	

Popis:

bt 1 : sonda teploty vody na výstupu

bt 2 : sonda teploty výměníku

bt 3 : sonda teploty prostředí

bt 10 : sonda teploty elektrického panelu (volba)

bP 1 : vysílač obvodu 1

bP 2 : vysílač obvodu 2; (z modelu ICEP080)

F_ _ : provoz ventilátoru:

F_ _ : ventilátor vypnutý

F_ - : ventilátor 1 zapnutý, ventilátor 2,3 vypnutý; (2 = z modelu ICEP022) (3 = z modelu ICEP080)

F- - : fans 1 a 2 zapnutý, ventilátor 3 vypnutý, (2 = z modelu ICEP022) (3 = z modelu ICEP080)

F- - : fans 1,2 a 3 zapnutý (z modelu ICEP080)

[IC 2 : provoz kompresorů:

[_ _ : kompresory deaktivovány









[- - : kompresory vypnutý

[IC - : Kompresor 1 zapnutý, Kompresor 2 vypnutý

[IC 2 : kompresory 1 a 2 zapnutý; (z modelu ICEP055)

[IC - : s blikající „1“ kompresor připraven ke spuštění, Kompresor 2 vypnutý

4.8 Nastavení hodin/data

<p>Zapněte chladič "ON" pomocí hlavního odpojovače QS a počkejte na zobrazení ukazatele „OFF“.</p> <p>Stiskněte současně tlačítka "⏪" a "⏩" a vstupte do nabídky „Data/čas“.</p>	
<p>Zobrazí se parametr "FrEE".</p> <p>Stiskněte tlačítko "set" k zadání.</p>	
<p>Zobrazí se parametr "A1".</p> <p>Použijte tlačítka "⏪" a "⏩" k volbě parametru "CL".</p>	
<p>Stiskněte tlačítko "set" k zadání.</p>	
<p>Zobrazí se parametr "HOUr".</p> <p>Stiskněte na 5 sekund tlačítko "set". Nyní parametr bliká.</p>	
<p>Použití tlačítka "⏪" a "⏩" k volbě změny data, hodiny nebo roku.</p>	
<p>Stiskněte tlačítko "set" k zadání 0</p>	
<p>Použijte tlačítka "⏪" a "⏩" ke změně hodnoty (např. roku).</p>	
<p>Stiskněte tlačítko "set" k potvrzení.</p>	

Použijte tlačítka "⏪" a "⏩" ke změně jiné hodnoty (např. data).



Stiskněte tlačítko "esc" k ukončení. Parametr přestane blikat.



Stiskněte současně tlačítka "⏪" a "⏩" k ukončení.



⚠ Maximální délka uchování „hodin/data“ v paměti jsou tři dny, takže pokud je ovladač ponechán bez napájení elektrickým proudem déle než tři dny, dojde ke ztrátě nastavení hodiny/měsíce/roku. Upravte hodinu při spuštění stroje a vždy, když je to nutné.





4.9 Řízení alarmu

<p>V případě alarmu se zobrazí kód alarmu a symbol vlevo nahoře</p> <p>⚠ Stálý = alarm je aktivní Bliká = varování / alarm lze resetovat</p>	
<p>Stiskněte tlačítko "set" k zadání.</p>	
<p>Zobrazí se parametr "RLH".</p> <p>Stiskněte tlačítko "↶" k volbě parametru "RL".</p>	
<p>Stiskněte tlačítko "set" k zadání.</p>	
<p>Zobrazí se kód alarmu: "Er04".</p> <p>Stiskněte tlačítko "↶" pro kontrolu, zda je v zařízení více alarmů.</p>	
<p>Před provedením resetu závadu opravte. Po odstranění závady začne blikat symbol alarmu. Nyní můžete provést reset.</p>	
<p>Stiskněte tlačítko "esc", dokud alarm nezmizí.</p>	

Seznam alarmů/varování

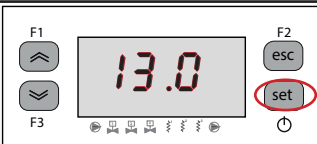
Kód	Popis	Akce	Reset
Er01	Senzor bt1 vypnutý nebo poškozený	Alarm	M
Er02	Senzor bt2 vypnutý nebo poškozený	Alarm	M
Er03	Senzor bt3 vypnutý nebo poškozený	Alarm	A
Er05	Senzor bt10 vypnutý nebo poškozený	Alarm	A
Er06	Senzor bP1 vypnutý nebo poškozený	Alarm	M
Er08	Spínač vysokého tlaku okruh 1	Alarm	M
Er09	Spínač nízkého tlaku okruh 1	Alarm	M
Er12	Vysoká teplota bt1	Alarm	M
Er13	Nízká teplota bt1	Alarm	A
Er14	Vysoká teplota bt2	Alarm	M
Er15	Nízká teplota bt2	Alarm	M
Er16	Vysoká teplota bt3	Alarm	A
Er17	Nízká teplota bt3	Alarm	A
Er18	Kompresor tepelná ochrana 1	Alarm	M
Er20	Čerpadlo tepelná ochrana 1	Alarm	M
Er22	Spínač nízké hladiny vody/tlakového rozdílu	Alarm	M
Er23	Monitor fází	Alarm	M
Er24	Expanze přerušená nebo odpojená	Alarm	M
Er25	Překročení pracovních hodin kompresoru 1	Varování	M
Er27	Překročení pracovních hodin jednotky	Varování	M
Er28	Paměť hodin	Varování	A
Er29	Konfigurace chladiče	Varování	A

4.10 Historie alarmů

Chladič v provozu. Stiskněte tlačítka "set" pro zobrazení a historii alarmů.	
Stiskněte tlačítka "set" k zadání.	
Použijte tlačítka "↓" a "↑" pro zobrazení parametrů. (Par. 4.5.5)	
Stiskněte tlačítka "set" pro zobrazení hodnoty.	

5 Údržba

• Stroj byl projektován a zkonstruován pro nepřetržitý provoz; životnost jeho dílů ovšem závisí na prováděné údržbě.

-  Při žádosti o pomoc nebo náhradní díly je nutné uvést přesné označení stroje (model a sériové číslo) uvedené na štítku umístěném na jednotce. (www.polewr.com)

5.1 Všeobecné pokyny

 Před zahájením jakékoli údržby se ujistěte, že napájení chladičového zařízení je odpojené.

 Vždy používejte originální náhradní díly výrobce, jinak je výrobce zproštěn veškeré odpovědnosti za poruchu stroje..

 V případě úniku chladiva se obraťte na kvalifikované a oprávněné pracovníky.

 Ventil Schrader se smí používat pouze v případě poruchy stroje, jinak se na škody způsobené nesprávným plněním chladiva nevztahuje poskytnutá záruka

5.2 Chladivo

Plnění: na škody způsobené nesprávným plněním chladiva provedené neoprávněnou osobou se

nevztahuje poskytnutá záruka. 













 Zařízení obsahuje fluorované skleníkové plyny.

Chladičí kapalina R513A s normální teplotou a tlakem je bezbarvý plyn ze skupiny SAFETY GROUP A1 - EN378 (kapalina skupiny 2 podle směrnice PED 2014/68/EU); GWP (Global Warming Potential) = 629.

 V případě úniku chladiva vyvětrejte místnost.

5.3 Program preventivní údržby

K zajištění maximální a trvalé výkonnosti a spolehlivosti zařízení je nutné provádět následující údržbu:

Popis činnosti údržby	Interval údržby (za podmínek standardního fungování)			
	Každý den	Každé 6 měsíce	Každé 12 měsíce	Každé 36 měsíce
<p>Činnost</p> <p>zkontrolujte  servis </p>				
Zkontrolujte, zda kontrolka POWER ON svítí.				
Zkontrolujte ukazatele ovládacího panelu.				
Vyčistěte žebra kondenzátoru.				
Zkontrolujte elektrický příkon.				
Zkontrolujte ztráty chladiva.				
Zkontrolujte a Vyčistěte Pojistný ventil voda (pokud je přítomen)*				
Zkontrolujte elektrický systém a elektrickém panelu**				
Zkontrolujte sondy teploty. V případě potřeby je vyměňte.				 
Souprava k údržbě				



K dispozici je (viz čás 7.):

- servisní sady: elektrická kit; Kompresor souprava; Elektrický ventilátor souprava; Výparník souprava; Čerpadlo souprava; Nádržka s vodou souprava;
- jednotlivé náhradní díly.

*Aby byla zajištěna plná účinnost, musí být bezpečnostní ventily pravidelně kontrolovány.

V průběhu času se nečistoty mohou usadit v blízkosti zástrčky; proto je nutné pravidelné proplachování sídla. Tohoto propláchnutí se provádí ručním vypuštěním ventilu otočením knoflíku ve směru označeném šipkami.

Důležité upozornění: Ujistěte se, že po této operaci je obnoven provozní tlak.

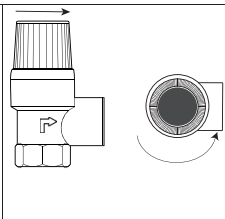

** Během pravidelné údržby musí být v souladu s místními předpisy zkontrolován také elektrický systém na stroji a na elektrickém panelu. Kromě toho by měla být vždy, pokud je to možné, provedena vizuální kontrola zařízení a elektrických vodičů a také musí být ověřeno správné dotažení svorek

výkonových součástí podle utahovacích momentů uvedených v elektrickém schématu.

5.4 Demontáž

Chladicí kapalina a mazací olej obsažené v okruhu je nutné rekuperovat v souladu s platnými místními předpisy:

Znovuzískání kapalného chladiva se provádí před konečným odstraněním zařízení ((EU) č 517/2014 § 8).

	Recyklace Likvidace 
rám a kryty	ocel/epoxidová pryskyřice, polyester
nádrž	hliník/měď/ocel
trubky/kolektory	měď/hliník/karbonová ocel
izolace trubek	nitrilový kaučuk
kompresor	ocel/měď/hliník/olej
kondenzátor	ocel/měď/hliník
čerpadlo	ocel/litina/mosaz
ventilátor	hliník
chladivo	R513A
ventil	mosaz/měď
elektrický kabel	měď/PVC

Zařízení obsahující elektrické součásti musí být likvidováno odděleně s elektrickým a elektronickým odpadem v souladu s místní a aktuální legislativou.



6 Řešení problémů

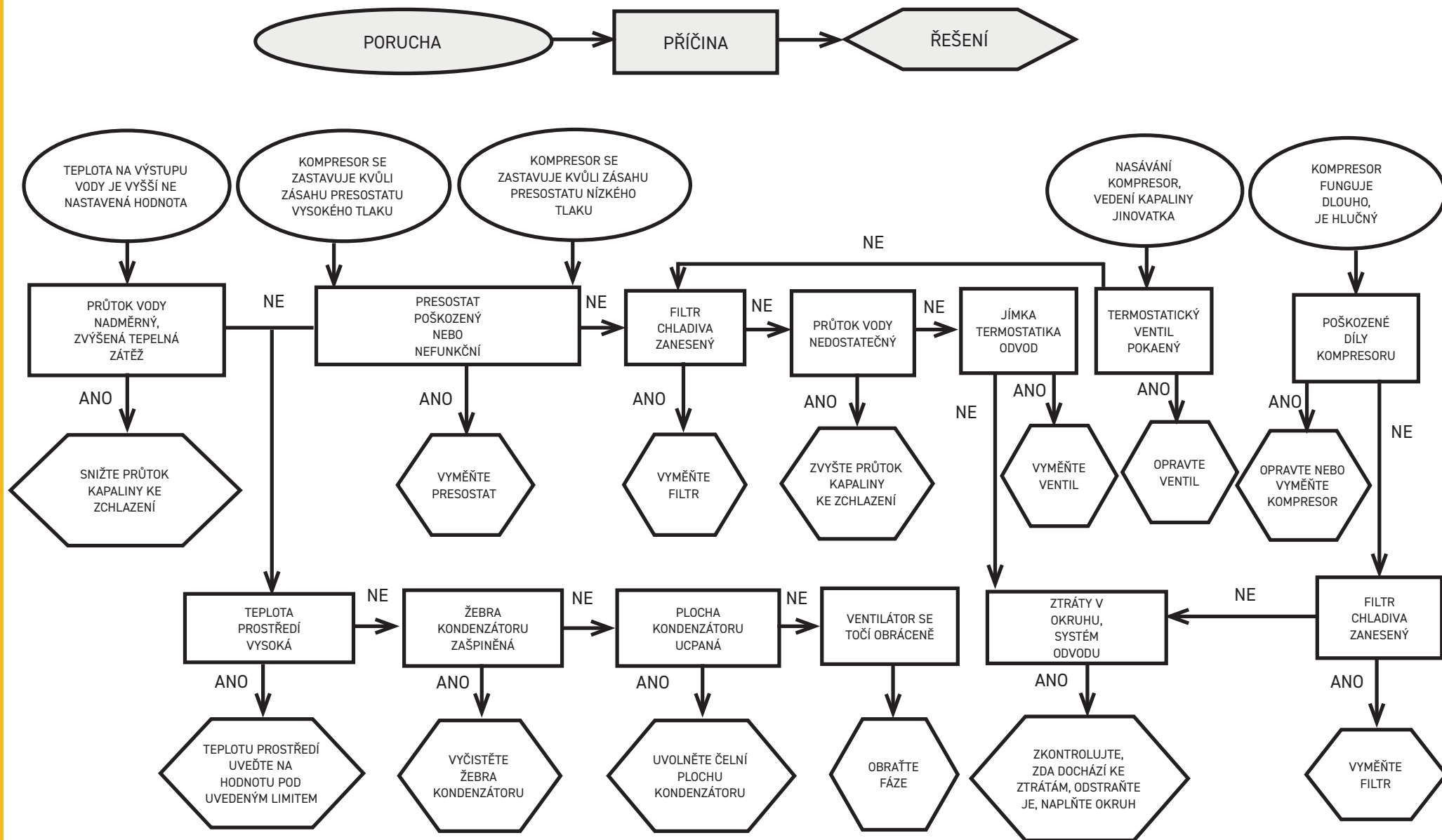

1 Biztonság	2
1.1 A kézikönyv fontossága	2
1.2 Figyelmeztető jelek	2
1.3 Biztonsági megjegyzések	2
1.4 Fennmaradó kockázatok	2
2 Bevezetés	3
2.1 Szállítás	3
2.2 Mozgatás	3
2.3 Szemle	3
2.4 Tárolás	3
3 Beszerelés	3
3.1 Operatív terület	3
3.2 Változatok	3
3.3 Vízkör	3
3.3.1 Ellenőrzések és bekötések	3
3.3.2 Víz és etilénlikol	4
3.3.3 Tágulási tartály	4
3.4 Elektromos kör	5
3.4.1 Ellenőrzések és bekötések	5
3.4.2 Általános riasztó	5
3.4.3 Távoli ON/OFF	5
3.5 Vizes változat (W)	5
4 Vezérlés	6
4.1 Vezérlőpult	6
4.2 Szimbólumok jelentése	6
4.3 Hűtőberendezés indítása	6
4.3.1 Beállítások az első indításkor	6
4.3.2 Magas hőmérsékletű vízzel kezdés	6
4.4 Hűtőberendezés leállítása	7
4.5 Paraméterbeállítások	7
4.5.1 Hűtő paraméterei (CF9)	7
4.5.2 Hőmérséklet-szabályozás (CNP)	7
4.5.3 Karbantartási paraméterek (PnE)	7
4.5.4 Szonda paraméterei (bE 1, bE2)	7
4.5.5 Riasztási előzmények (RLH 1)	7
4.6 Paraméterek módosítása (User)	8
4.6.1 Hűtő paraméterei „CF9”	8
4.6.2 Hőmérséklet-szabályozás „CNP”	13
4.6.3 „bE 1” szondaparaméter	14
4.7 Vizualizációja szonda/ ventilátor/ Kompresszor	14
4.8 Óra/dátum beállítása	15
4.9 Riasztáskezelés	16
4.10 Riasztási előzmények	17
5 Karbantartás	17
5.1 Általános figyelmeztetések	17
5.2 Hűtő	17
5.3 Rendszeres karbantartási program	18
5.4 Semlegesítés	18





7 Tartalom
7.1 legenda
7.2 Beszerelési rajz
7.3 Mozgatás -Operatív terület
7.4 Műszaki adatok
7.5 Méretek
7.6 Alkatrészlista
7.7 Robbantott rajzok
7.8 Hálózati rajz
7.9 Kapcsolási rajz

1 Biztonság

1.1 A kézikönyv fontossága

- A gép teljes élettartama alatt őrizze meg.
- Mielőtt bármilyen műveletbe belekezdene, olvassa el.
- Módosítható: az aktuális információt a gép mellett található használati utasítás tartalmazza.

1.2 Figyelmeztető jelek

	Utasítások a személyi sérülések elkerülésére.
	Utasítások a berendezés károsodásának elkerülésére.
	Jelen kell legyen egy tapasztalt és felhatalmazott szakember.
	Olyan szimbólumok szerepelnek, amelyek jelentése a következő bekezdésben található: 7.

1.3 Biztonsági megjegyzések

 Minden gép elektromos szakaszolóval van ellátva a biztonságos körülmények közötti beavatkozáshoz. Mindig használja ezt a készüléket, hogy karbantartás idején kizárja a veszélyeket.

 A kézikönyv a végfelhasználónak készült kizárólag a zárt panelekkel elvégezhető műveletekre vonatkozóan: azon műveleteket amelyekhez különféle szerszámokkal ki kell nyitni a gépet, képzett és tapasztalt szakember kell, hogy végezze.

 Kizárólag olyan helyeken telepíthető, amelyek nem férhetnek hozzá a nagyközönség számára, akár korlátozott hozzáférésű, biztonságos helyen, akár legalább 2,5 m magasságban, illetve biztosított tetőtéri területeken, kivéve, ha a biztonságukért felelős személy felügyeli őket, vagy elgázítást nyújt a készülék használatáról.



 A faltól való szerelési távolságot és a szabad üzemi területet a 7.3. bekezdés tartalmazza.

 Figyelem: tartsa be a 7.4. bekezdésben feltüntetett min./max. hőmérsékletet és nyomást, valamint a 7.2. bekezdésben feltüntetett teljes üzemi hőmérséklet-tartományt.

 Minden egység kültéren is telepíthető.

 Minden elektromos csatlakozás meg kell feleljen a beszerelés helyén érvényes előírásoknak.

 Ne lépje túl az adattáblán megadott tervezési határértékeket.

  A felhasználó feladata, hogy elkerülje a belső statikus nyomástól eltérő terhelést. Amennyiben földrengésveszély kockázata áll fenn, a gépet el kell látni a megfelelő védelemmel. Az egységet kizárólag szakszerű használatra és a tervezésének megfelelő célra alkalmazza;

 A felhasználó feladata, hogy elemezze a termék beépítési körülményeinek összes aspektusát, hogy kövesse az egységgel együtt leszállított használati utasításban és minden egyéb dokumentumban megjelölt összes alkalmazandó ipari normát és a termékre vonatkozó minden előírást. Ha arra fel nem hatalmazott személy a gépet átalakítja, vagy annak bármely részegységét kicseréli, és/vagy a gépet nem rendeltetésszerűen használja, a gyártó mentesül minden felelősség alól, és az ilyen eljárás személyi sérülést okozhat.

A gyártó semmilyen felelősséget nem vállal azon jelen és jövőbeli személyi sérülésért, tárgyakban vagy magában a gépben bekövetkező kárért, ami a gépkezelők gondatlanságából, a jelen kézikönyvben megadott utasítások be nem tartásából, illetve a berendezés biztonságára vonatkozó hatályos előírások alkalmazásának hiányából származik.

A gyártó nem vállal felelősséget a csomagolás változtatása és/vagy módosítása miatt bekövetkező esetleges kárért.

A felhasználó felelőssége biztosítani, hogy a gép kiválasztásához megadott specifikáció és/vagy opciók kimerítőek legyenek a gép és részegységei korrekt és ésszerűen előre látható használata szempontjából.

 **FIGYELEM: A gyártó fenntartja a jogot, hogy bármiféle előzetes értesítés nélkül változtassa a jelen kézikönyv szövegét. Javasoljuk a felhasználónak, hogy olvassa el az egységen található kézikönyvet a teljes körű és naprakész információk megszerzéséhez.**

1.4 Fennmaradó kockázatok

A gép beszerelése, beindítása, kikapcsolása és karbantartása szigorúan a termék műszaki dokumentációjában megadottak szerint kell, hogy történjen, és oly módon, hogy ne alakuljon ki semmilyen kockázatos helyzet.

Az alábbi táblázat tartalmazza azokat a kockázatokat, amelyeket a tervezés folyamán nem lehetett kizárni..

a vonatkozó rész	fennmaradó kockázat	módok	óvintézkedések
hőcserélő elem	kis vágott sebek	érintkezés	kerülje el az érintkezést, használjon védőkesztyűt
ventillátor rács és ventillátor	sérülések	hegyes eszközök bejutása a rácson keresztül a ventillátor működése közben	a ventillátor rácsba ne illesszen be semmilyen tárgyat, és ne helyezzen el semmit a rácson
egység belseje: kompresszor és odairányú cső	égési sebek	érintkezés	kerülje el az érintkezést, használjon védőkesztyűt
egység belseje: fémrészek és elektromos kábelek	belélegzés, áramütés okozta sérülés, súlyos égési sebek	az egység elektromos kapcsolószekrénye előtti tápvezeték szigetelési hibája. Feszültség alatti fémes részek	a tápvezeték megfelelő elektromos védelme A fémes részek gondos földelése

a vonatkozó rész	fennmaradó kockázat	módok	óvintézkedések
egység külseje: az egység körüli terület	belélegzés, súlyos égési sebek	az egység elektromos kapcsolószekrénye előtti tápvezeték zárata vagy túlmelegedése miatt bekövetkező tűz	az érvényes szabványoknak megfelelő kábelszakaszok és tápvezeték védelmi rendszer

2 Bevezetés

A kompresszor-, szivattyú- és ventilátormotorok hővédelemmel vannak ellátva, amely megvédi őket az esetleges túlhevüléstől.

2.1 Szállítás

Biztosítani kell, hogy a becsomagolt egység:

- maradjon függőleges helyzetben;
- légköri hatások ellen védve legyen;
- ütések ellen védve legyen.

2.2 Mozgatás

Az emelendő tömegnek megfelelő villástargoncát használjon, kerüljön mindenfajta ütést.

2.3 Szemle

- A gyárban minden egységet összeszerelnek, kábeleznek, feltöltenek hűtőfolyadékkal és olajjal, és kipróbálnak;
- a gép átvételkor ellenőrizze annak állapotát: a fuvarozó cégnél azonnal emeljen kifogást az esetleges károk miatt;
- a gépet a beszerelés helyéhez lehető legközelebb csomagolja ki.

2.4 Tárolás

- A becsomagolt egységet tiszta és nedvességtől, valamint az időjárási hatásoktól védett helyen tartsa;
- ne tegye egymásra az egységeket;
- kövesse a csomagoláson található utasításokat.

3 Beszerelés

 Az optimális beszereléshez tartsa be a 7. bekezdésben leírtakat.

 A telepített terméket megfelelően védeni kell a tűzveszély ellen (EN378-3 hivatkozás).

 **Ajánlott, hogy minden hűtőberendezést megfelelő előszűrővel szereljenek fel a hűtőberendezéshez közeli bemenő vízhez (tisztítás fokát min.05mm; max1.0mm).**

 **Hűtőfolyadékok**

A hűtőfolyadékok a használt anyagokkal kompatibilisek kell legyenek.

Példák az alkalmazott folyadékra: **víz, víz és etilén vagy propilén glikol keveréke.**

A hűtőfolyadékok nem lehetnek gyúlékonyak.

Ha a hűtőfolyadék veszélyes anyagot tartalmaz (mint például az etilén/propilén-glikol), az esetleges szivárgó területen eltávolító folyadékot be kell gyűjteni, mert károsítja a környezetet. A hidraulikus kör ürítése esetén tartsa be az érvényes előírásokat, és a berendezés tartalmát ne engedje ki a szabad természetbe.

3.1 Operatív terület

 **Az egység körül hagyjon 1,5 méter helyet.**

A vertikális kondenz levegő kibocsátó modelleknél a hűtő fölött hagyjon legalább 2 méter szabad teret.

3.2 Változatok

Levegős változat: Tengelyes ventilátorok (A)

A hűtőlevegő ne legyen visszakeringetve.

Ne tömítse el a szellőző rácsokat.

Az axiális ventilátorral ellátott változatoknál nem javasoljuk a telített levegő csatornában történő elvezetését.

Vizes változat(W)



Ha a kondenzátornál a víz nyitott körben van, a kondenzvíz bemenetre szereljen fel hálós szűrőt.

Különleges (ioncserélt, demineralizált, desztillált) hűtővizek esetén lehetséges, hogy a kondenzátor szabványos anyagai nem felelnek meg. Ilyen esetben, kérjük, vegye fel a kapcsolatot a gyártóval.

3.3 Vízkör

3.3.1 Ellenőrzések és bekötések

 A hűtő bekötése és a kör feltöltése előtt ellenőrizze, hogy tiszták-e a csövek. Ellenkező esetben gondosan mossa át őket.

  **Ha a vízkör zárt és nyomás alatt van, akkor egy 6 barra beállított biztonsági szelep van beépítve.**

 Javasoljuk, hogy a vízbemeneti és kimeneti csőre mindig szereljen fel hálózati szűrőt.

 Ha a vízkörben automatikus szelepek vannak, védje le a szivattyút a nyomásimpulzustól védő rendszerrel.

 Ha hosszabb leállás miatt kiürítik a kört, javasoljuk, hogy töltsön kenőfolyadékot a szivattyú forgórészére, hogy a következő indításkor ne akadjon el. A forgórész elakadásakor azt manuálisan oldja ki.

Távolítsa el a szivattyú hátsó fedelét, és finoman forgassa meg a műanyag keverőlapátot. Ha a tengely még mindig el van akadva, vegye ki a keverőlapátot, és közvetlenül a tengelyt forgassa meg. A forgórész kioldását követően helyezze vissza a keverőlapátot és a fedelet.

Előzetes ellenőrzés

1. Ellenőrizze, hogy a vízkör esetleges visszacsapó szelepei nyitva vannak-e.
2. Ha a vízkör zárt típusú, ellenőrizze, hogy fel van-e szerelve egy megfelelő kapacitású tágulási tartály.

Bekötés

1. Az egység felső részén elhelyezett megfelelő csatlakozó egységekkel kösse be a vízhűtőt a bemeneti és kimeneti csövekre.
2. Javasoljuk flexibilis csatlakozás alkalmazását, hogy ne legyen merev a rendszer.
3. A hűtő hátsó részén elhelyezett megfelelő feltöltő csatlakozóval töltsen fel a vízkört (.
4. Javasoljuk, hogy a bemeneti és kimeneti csöveket lássák el egy csappal, mert így karbantartás esetén a gépet le lehet választani..
5. If the chiller works with an open tank, the pump must be installed on intake to the tank and on delivery to the chiller.

 **WFgyelem (022-120 modellek): a gép automatikusan védőberendezéssel van ellátva a tartály számára.**

Ha a víz bemeneti nyílása véletlenül bezáródik, amikor a szivattyú jár, és a víz kimenet nyitva van, akkor a levegő a szintérzékelő valószínű beavatkozása útján kerül a tartályba. A levegő eltávolításához szükség van a hidraulikus kör légtelenítésére.

További ellenőrzések

1. Ellenőrizze, hogy a tartály és a kör teljesen fel van-e töltve vízzel, és megfelelően légtelenítve van-e.
2. A vízkör mindig feltöltött kell legyen. Ebből a célból vagy rendszeres ellenőrzést és feltöltést kell végezni, vagy a berendezést el lehet látni egy automatikus feltöltő készlettel.

Vízzel jellemzői

Ha nem képezi a szállítást részét, szereljen hálózati szűrőt a kondenzáló víz bemenetre.

  Vízzel jellemzői

Teplota	≥50°F (10°C)	CL ⁻	<50 ppm
ΔT IN/OUT	5-15°C	CaCO ₃	70-150 ppm
Max % glykolu	50	O ₂	<0.1 ppm
Tlak	43.5-145 PSig (3-10 barg)	Fe	<0.2 ppm
PH	7.5-9	NO ₃	<2 ppm
Měrná elektrická vodivost	10-500 μS/cm	HCO ₃ ⁻	70-300 ppm
Langelierův index nasycení	0-1	H ₂ S	<0.05 ppm
SO ₄ ²⁻	<50 ppm	CO ₂	<5 ppm
NH ₃	<1 ppm	Al	<0.2 ppm

Különleges (ioncserélt, demineralizált, desztillált) vizek esetén lehetséges, hogy a hűtőt szabványos

anyagai nem felelnek meg. Ilyen esetben, kérjük, vegye fel a kapcsolatot a gyártóval.

3.3.2 Víz és etilénlikol

Ha szabadban van felszerelve, vagy zárt, de nem fűtött környezetben, előfordulhat, hogy a gépnek az év hidegebb időszakában tö

rténő leállása idején a vízkörben megfagy a víz.

A veszély csökkentése érdekében:

- lássa el a hűtőt megfelelő fagymentes védelemmel, amit a gyártó külön megrendelés alapján szállít;
- b) hosszabb leállások idején eressze le a berendezést a megfelelő lefolyó szelepen keresztül;
- c) a keringő vízhez adjon megfelelő mennyiségű fagyállót (lásd a táblázatot).

Kifolyó víz hőmérséklete [°C]	Etilénlikol (% vol.)	Környezeti hőmérséklet
4	5	-2
2	10	-5
0	15	-7
-2	20	-10
-4	25	-12
-6	30	-15
-10	40	-20

3.3.3 Tágulási tartály

Annak elkerülésére, hogy a hőmérséklet jelentős változása miatti folyadékterfogat növekedés vagy csökkenés a gépet vagy a kört károsítsa, javasoljuk egy megfelelő űrtartalmú tágulási tartály felszerelését.

A tágulási tartályt a tartály hátsó csatlakozójára a szivattyúhoz képest elszívó helyen kell felszerelni. Egy zárt körre szerelendő tágulási tartály űrtartalmának számításához az alábbi képletet lehet használni:

$$V=2 \times \text{Vössz} \times (P_t \text{ min} - P_t \text{ max})$$

ahol

Vössz= térf. a kör összesen (literben)

P t min/max = fajsúly a víz által elérhető minmális/maximális hőmérsékleten [kg/dm³].

A hőmérséklet és a glikol százalékos aránya szerinti fajsúly értékek a táblázatban szerepelnek.

% glycol	Hőmérséklet [°C]						
	-10	0	10	20	30	40	50
0%	1.0024	1.0008	0.9988	0.9964	0.9936	0.9905	0.9869
10%	1.0177	1.0155	1.0130	1.0101	1.0067	1.0030	0.9989
20%	1.0330	1.0303	1.0272	1.0237	1.0199	1.0156	1.0110
30%	1.0483	1.0450	1.0414	1.0374	1.0330	1.0282	1.0230
40%	1.0636	1.0594	1.0525	1.0511	1.0461	1.0408	1.0350

 **Figyelem: Töltéskor ügyelni kell a tágulási tartályon szereplő adatokra is.**

Ha a környezeti levegő hőmérséklete a hűtőnél alacsonyabb, mint -10°C, akkor a tágulási tartályt védett környezetbe kell helyezni, közel a hűtővíz visszatérő oldalán. A biztonsági szelepnek és a légtelenítő szelepnek a hűtőben kell maradnia.

3.4 Elektromos kör

3.4.1 Ellenőrzések és bekötések

 Mielőtt bármilyen műveletet végezne az elektromos részeken ellenőrizze, hogy nincsenek-e feszültség alatt.

Minden elektromos csatlakozás meg kell feleljen a beszerelés helyén érvényes előírásoknak.

Kezdő ellenőrzések

1. A hálózati feszültség és frekvencia értékek meg kell feleljenek a hűtő adattábláján szereplő értékeknek. A tápfeszültség rövid időre sem eshet a kapcsolási rajzon megadott tűrőhatáron kívül, ami egyéb jelzés hiánya esetén a feszültségérték +/- 10%; +/- 1% a frekvencia esetén.
2. A feszültség szimmetrikus kell legyen (a feszültségek hatásértékei és az egymás utáni fázisok fázisszögei egyenlők). A feszültségértékek közötti maximálisan megengedett egyenletesség hiány 2%.

Bekötés

1. A hűtők elektromos betáplálása 4 eres, 3 pólus + föld, nulla nélkülvezetéssel történik. A keresztmetszetre vonatkozóan lásd a fejezetet 7.
2. Vezesse át a vezetékét a gép hátsó panelén lévő tömszelencén és kösse be a fő szakaszoló (QS) kapcsaira a fázist és a nullát, a földelést a megfelelő földkapocsra (PE) kell bekötni.
3. A tápvezeték elején biztosítson a közvetlen kontaktusok elleni legalább IP2Xo IPXXB védelmet.
4. A hűtő elektromos tápvezetékére szereljen fel egy (RCCB - IDn = 0.3A) differenciálú automatikus megszakítót, amelynek a maximális hozama a megfelelő kapcsolási rajzon szerepel, a megszakítási erő a gép beszerelési zónájában érvényes rövidzár áramerősségének megfelelő kell legyen.
5. Ezen hőmágneses megszakító „In” névleges áramerőssége meg kell egyezzen az FLA értékkel, valamint a beavatkozási görbéje D típusú kell legyen.
6. Maximális hálózati impedancia érték = 0,274 ohm.

További ellenőrzések

Ellenőrizze, hogy a gép és a kiegészítő berendezések le lettek-e földelve és védve vannak-e a rövidzár és/vagy túlterhelés ellen.

 **Amikor az egység be van már kötve és az egység előtti főkapcsoló le van zárva (vagyis a gép feszültség alá van helyezve) az áramkörben a feszültség veszélyes értékeket vesz föl. Maximális óvintézkedések!**

 **A kivitelező felelőssége elvégezni azokat a minimálisan előírt ellenőrzéseket, amelyekkel biztosítható a helyi előírásoknak és a csatlakoztatott földelő rendszer tulajdonságainak megfelelő elektromos bekötés, beleértve az IT-rendszerek (földtől elszigetelt vagy impedancián keresztül földelt rendszerek) specifikus követelményeinek való megfelelést is.**

3.4.2 Általános riasztó

Minden hűtő el van látva riasztó jelzéssel (lásd a kapcsolási rajzot), ez a kapocslécen szabad váltó kontaktusként jelenik meg. Ez lehetővé teszi olyan riasztó bekötését, amely központi külső, akusztikus, vizuális vagy logikai pl. PLC.

3.4.3 Távoli ON/OFF

Minden hűtőnél meg van a lehetőség távoli indító és leállító vezérlésre (fejezetet 7.).

- A távoli rief engedélyezéséhez. n.16387

- Referenciaváltozóként ON/OFF rief.n.8996

Megjegyzés: ne engedélyezze együtt a „Sup” és „Re” opciókat.

A távoli ON-OFF kontaktus bekötését lásd a kapcsolási rajzot (fejezetet 7.)

3.5 Vizes változat (W)

A vízkondenzációs folyadékűtőknek olyan vízkörre van szükségük, amely a hideg vizet a kondenzátorhoz juttatja.

A vizes változatú vízűtő a kondenzátor bemenetnél presszosztatikus szeleppel van ellátva, amelynek feladata a vízhozam szabályozása úgy, hogy a kondenzáció mindig optimális legyen.

Előzetes ellenőrzés

Ha a kondenzátor víz betáplálása zárt körrel történik, végezze el a fő vízkörnél felsorolt összes előzetes ellenőrzést (3.3.1 fejezet).

Bekötés

1. Javasoljuk, hogy lássa el a kondenzációs vízkört visszacsapó szeleppel, hogy karbantartás esetén le lehessen választani a gépet.
2. Kösse be a víz oda/vissza irányú csöveket az egység hátulján lévő megfelelő csatlakozásokra.
3. Ha a kondenzvizet "nem hasznosítják", javasoljuk, hogy a kört lássa el egy kondenzátor bemeneti szűrővel a felületek szennyeződése kockázatának korlátozására.
4. Ha a kör zárt típusú, ellenőrizze, hogy jól fel legyen töltve vízzel és megfelelően légtelenítve legyen.

4 Vezérlés

4.1 Vezérlőpult



FEL gomb: nyomja meg a kiválasztott módosítható paraméter értékének növeléséhez.



LE gomb: nyomja meg a kiválasztott módosítható paraméter értékének csökkentéséhez.



ESC gomb: a mentés nélküli kilépéshez; visszatér az előző szintre;

5 másodpercig NYOMVA TARTVA. RIASZTÁS VISSZAÁLLÍTÁSA.



SET gomb: a kilépéshez és az érték mentéséhez/megerősítéséhez; a következő szintre lépés; belépés a Beállítások menübe;
5 másodpercig NYOMVA TARTVA. HŰTŐ INDÍTÁSA.

4.2 Szimbólumok jelentése

Szimbólum	Szimbólum állapota	Funkció	Szimbólum	Szimbólum állapota	Funkció
	Világít	Kompresszor BE		Világít	Hőmérsékletérték
	Villog	Kompresszor készenlétben		Világít	Nyomásérték
	Nem világít	Kompresszor ki		Világít	Fagymentesítő fűtés BE
	Világít	Riasztás jelen		Világít	Nyomásérték
	Villog	Figyelmeztetés vagy Riasztás, nullázható		Világít	Fagymentesítő fűtés BE
	Nem világít	Nincs riasztás		Nem világít	Fagymentesítő fűtés ki
	Világít	Szivattyú 1 BE		Világít	Forgattyúház fűtés BE Kompresszor 1
	Nem világít	Szivattyú 1 ki		Nem világít	Forgattyúház fűtés ki Kompresszor 1
	Világít	Szivattyú 2 BE (nincs jelen)		Világít	Forgattyúház fűtés BE Kompresszor 2 (nincs jelen)
	Nem világít	Szivattyú 2 ki (nincs jelen)		Nem világít	Forgattyúház fűtés ki Kompresszor 2 (nincs jelen)

4.3 Hűtőberendezés indítása

1. A QS fő leválasztó kapcsoló BE kapcsolásával csatlakoztassa a gépet az áramellátáshoz.
2. Nyomja meg a "set" gombot az indításhoz.
3. Állítsa be a kívánt hőmérsékletet a vezérlőn. (4.5.1 bekezdés)

Fázismonitor

Ha a kijelzőn "E-23" riasztás jelenik meg, a fel-használónak ellenőriznie kell, hogy a választókapcsoló be-meneti kapcsainak kábelezését helyesen hajtotta-e végre.

4.3.1 Beállítások az első indításkor

1. W Hőmérséklet-beállítás. új beállítás elvégzéséhez lásd a 4.5 pontot.
2. b) A szivattyú működésének ellenőrzését a nyomásmérő (P1 és P0 leolvasása) és a szivattyú adattábláján látható nyomás határértékek (Pmax és Pmin) segítségével végezze.

P1 = nyomás ON szivattyúval

P0 = nyomás OFF szivattyúval

$P_{min} < (P1 - P0) < P_{max}$

- 1. példa.

Feltételek:

zárt kör P0 nyomása 2 bar

szivattyú adattábla: Pmin 1 bar/ Pmax 3 bar

szelep kimenet beállítása 3 bar nyomásra < $P1 < 5$ bar

- 2. példa.

Feltételek:

nyitott kör P0 nyomása 0 bar

szivattyú adattábla: Pmin 1 bar/ Pmax 3 bar

szelep kimenet beállítása 1 bar nyomásra < $P1 < 3$ bar

3. Normál üzemi feltételek esetén is ellenőrizze a szivattyú helyes működését. Ellenőrizze továbbá, hogy a szivattyú áramerőssége az adattábla szerinti határértékek közé essen.
4. A chiller kikapcsolása után a „SET” hőmérsékleten végezze el a hidraulikakör utántöltését.
5. Ügyeljen arra, hogy a „kezelt” víz hőmérséklete ne menjen 5 °C alá és hogy a hidraulikakör környezeti hőmérséklete ne menjen 5 °C alá. Ellenkező esetben adjon megfelelő mennyiségű glikolt a vízhez, a 3.3.2 pontban leírtak szerint.



FIGYELEM! A hűtőszivattyú bekapcsolása előtt zárja el a vízkivezető szelepet (felszereléséről az ügyfél gondoskodik).

A bemeneti szelepet (felszereléséről az ügyfél gondoskodik) mindig tartsa nyitva.

Kapcsolja be a szivattyút, lassan nyissa meg a hűtő vízkivezető szelepet, és állítsa be az áramlási sebességet a 4.3.1. pontban leírtak szerint.

4.3.2 Magas hőmérsékletű vízzel kezdés

Ha a kör vízhőmérséklete magas (például 30-35°C), fokozatosan zárja el (de nem teljesen, körülbelül kétharmadáig!) az elzárószelepet (az ügyfélszolgálatnál) a hűtő kimeneténél, hogy csökkentse a víz áramlását az egységen keresztül. Fokozatosan nyissa ki a szelepet, amint a víz hőmérséklete eléri az üzemi értéket.

Fontos: ebben az esetben több magasnyomású riasztás is előfordulhat, amelyeket manuálisan kell visszaállítani.

Fontos: ez a beállítás lehetővé teszi a csövek mentén a körben lévő légbuborékok miatti vízlökések elkerülését is (a légbuborékokat a hidraulikus kör legmagasabb pontjain található légtelenítő szelepeken keresztül kell eltávolítani a vevő által).

4.4 Hűtőberendezés leállítása

Amikor a hűtőberendezés működésére nincs többet szükség, az alábbiak szerint állítsa le: nyomja meg

a "set" gombot (5 mp-ig).

Ne kapcsolja ki a QS főkapcsolót, hogy biztosítsa, a fagyvédő készülékek továbbra is áramot kapnak.

4.5 Paraméterbeállítások

Általános

Két védelmi szint van a paraméterek számára:

- Közvetlen User-(U): azonnali hozzáféréssel, **Felhasználó által módosítható**;
- Jelszóval védett Service-(S): a hozzáféréshez jelszó szükséges **(ne változtassa meg)**.

4.5.1 Hűtő paramétere (CF9)

PARAMÉTER	KÓD	TÍPUS	DEFAULT
Mértékegység.	R1	U	OFF
Riasztás relé kezelése	CFJ1	U	0
Alapértelmezett paraméterek visszaállítása	DEF	U	OFF
Távoli be/ki engedélyezése	R7	U	0
Szoftver verzió	UEr	U	1.7.0
Egység címe	CF30	U	1
Átviteli sebesség	CF31	U	3
Modbus protokoll	CF32	U	1
Felügyelő be/ki engedélyezése	SUP	U	OFF
Dinamikus beállítási pont engedélyezése	ErD	U	OFF

4.5.2 Hőmérséklet-szabályozás (CNP)

PARAMÉTER	KÓD	TÍPUS	ALAPÉRT-TELMEZÉS
Hőmérséklet-szabályozás beállítási pontja (standard)	SEt	U	13.0
Hőmérséklet-szabályozás beállítási pontja (precíziós szabályozás)	SEt	U	20.0
Hőmérséklet-szabályozási differenciál (NEM jelenik meg a „precíziós szabályozás” konfigurációban)	dIF1	U	4.0

4.5.3 Karbantartási paraméterek (Mnt)

PARAMÉTER	KÓD	TÍPUS	ALAPÉRT-TELMEZÉS
Egység üzemórái	UH	U	-
Egység üzemórái (X1000)	UHL	U	-
Egység részleges üzemórái	UPH	U	-
Egység részleges üzemórái (X1000)	UPHL	U	-

PARAMÉTER	KÓD	TÍPUS	ALAPÉRT-TELMEZÉS
Kompresszor üzemórái 1	CH	U	-
Kompresszor üzemórái 1 (x1000)	CHL	U	-

4.5.4 Szonda paramétere (bt 1, bt2)

Szonda (bt 1)

PARAMÉTER	KÓD	TÍPUS	ALAPÉRT-TELMEZÉS
Magas hőmérsékleti riasztás (víz)	HR1	U	50

Szonda (bt2)

PARAMÉTER	KÓD	TÍPUS	ALAPÉRT-TELMEZÉS
Magas hőmérsékleti riasztás (víz)	HR2	U	50







4.5.5 Riasztási előzmények (ALH i)

PARAMÉTER	KÓD	TÍPUS	ALAPÉRT-TELMEZÉS
Riasztás száma	HYS P	U	-
A riasztás kódjának megtekintése	HYS C	U	-
A riasztás napjának és hónapjának megtekintése	HYS d	U	-
A riasztás órájának és percének megtekintése	HYS t	U	-
bt1 hőmérséklet a riasztás időpontjában	HYS 1	U	-
bt2 hőmérséklet a riasztás időpontjában	HYS 2	U	-
BEÁLLÍTOTT körülmények a riasztás időpontjában	HYS 3	U	-



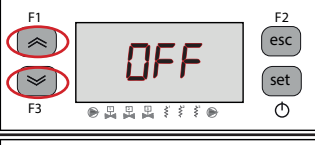

4.6 Paraméterek módosítása (User)

4.6.1 Hűtő paramétere „CF9”

Mértékegység.

Kapcsolja be a hűtőt „ON” a QS főkapcsolóval, és várja meg a kijelzőn az „OFF” jelzést. A „esc” „set” gombok együttes megnyomásával lépjen be a „U” paraméterekbe.	
Megjelenik a „PAR” paraméter. Nyomja meg a „set” gombot a belépéshez.	
Megjelenik a „CF9” paraméter. Nyomja meg a „set” gombot a belépéshez.	
Megjelenik az „A1” paraméter. Nyomja meg a „set” gombot a belépéshez	
Az alapértelmezett „OFF” = °C A „>” és „<” gombokkal válassza ki a mértékegységet. OFF: hőmérséklet = °C, Celsius; nyomás = Bar; On: hőmérséklet = °F, Fahrenheit; nyomás =PSI	
Nyomja meg a „set” gombot a megerősítéshez.	
Automatikusan visszatér az „A1”-hez A paraméter most már tárolásra került. Nyomja meg háromszor a „esc” gombot a kilépéshez.	

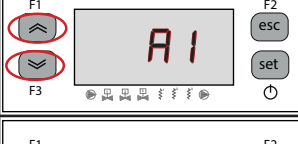
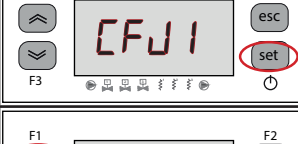
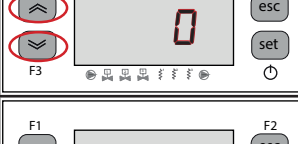
Riasztáskezelés

Kapcsolja be a hűtőt „ON” a QS főkapcsolóval, és várja meg a kijelzőn az „OFF” jelzést. A „esc” „set” gombok együttes megnyomásával lépjen be a „U” paraméterekbe.	
Megjelenik a „PAR” paraméter. Nyomja meg a „set” gombot a belépéshez.	
Megjelenik a „CF9” paraméter. Nyomja meg a „set” gombot a belépéshez.	
Megjelenik az „A1” paraméter. A „>” és „<” gombokkal válassza ki a „CFU1” paramétert.	
Nyomja meg a „set” gombot a belépéshez.	
Az alapértelmezett érték „0” A „>” és „<” gombokkal válassza ki a riasztási relék kezelését (4.5.1 bekezdés - 1. táblázat)	
Nyomja meg a „set” gombot a megerősítéshez.	
Automatikusan visszatér a „CFU1”-hez A paraméter most már tárolásra került. Nyomja meg háromszor a „esc” gombot a kilépéshez.	

1. táblázat – Riasztási relék kezelése (CFU1.)

0	Normál esetben kikapcsolt, riasztás által gerjesztett relé.
1	Normál esetben gerjesztett relé (a vezérlés kikapcsolt állapotában is), riasztás hatására deaktiválódik.
2	A relé normál esetben gerjesztett (csak a vezérlés ON állapotában), riasztás vagy a vezérlés OFF állapotában deaktiválódik.

Alapértelmezett paraméterek

Kapcsolja be a hűtőt „ON” a QS főkapcsolóval, és várja meg a kijelzőn az „OFF” jelzést. A „esc” „set” gombok együttes megnyomásával lépjen be a „U” paraméterekbe.	
Megjelenik a „PAR” paraméter. Nyomja meg a „set” gombot a belépéshez.	
Megjelenik a „CF9” paraméter. Nyomja meg a „set” gombot a belépéshez.	
Megjelenik az „A1” paraméter. A „>” és „<” gombokkal válassza ki a „dEF” paramétert.	
Nyomja meg a „set” gombot a belépéshez.	
Az alapértelmezett érték „OFF” A „>” és „<” gombokkal váltson az „OFF” értékről az „On” értékre.	
Nyomja meg a „set” gombot a megerősítéshez.	
Néhány másodperc múlva térjen vissza a „OFF” értékre. A paraméterek automatikusan alaphelyzetbe álltak. Nyomja meg háromszor a „esc” gombot a kilépéshez.	





Távoli ON/OFF

Kapcsolja be a hűtőt „ON” a QS főkapcsolóval, és várja meg a kijelzőn az „OFF” jelzést. A „esc” „set” gombok együttes megnyomásával lépjen be a „U” paraméterekbe.	
Megjelenik a „PAR” paraméter. Nyomja meg a „set” gombot a belépéshez.	
Megjelenik a „CF9” paraméter. Nyomja meg a „set” gombot a belépéshez.	
Megjelenik az „A1” paraméter. A „>” és „<” gombokkal válassza ki a „A7” paramétert.	
Nyomja meg a „set” gombot a belépéshez.	
Az alapértelmezett érték „0” A „>” és „<” gombokkal válassza ki az üzemmódot: (4.5.1. bekezdés - 2. táblázat)	
Nyomja meg a „set” gombot a megerősítéshez.	
Automatikusan visszatér a „A7”-hez A paraméter most már tárolásra került. Nyomja meg háromszor a „esc” gombot a kilépéshez.	





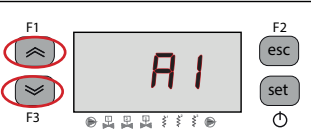

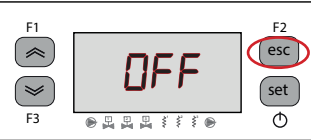

2. táblázat - Távoli be/ki üzemmód (A7)

0	Távoli be/ki letiltva
1	A távoli be/ki a helyi be/ki kapcsolással együtt engedélyezve. Áramkimaradás esetén, illetve ha a főkapcsolót lekapcsolják, a tápellátás helyreállításakor a hűtőt helyileg kell újraindítani.
2	Csak a távoli be/ki engedélyezve, helyi be/ki letiltva







Szoftververzió (csak olvasható)

<p>Kapcsolja be a hűtőt „ON” a QS főkapcsolóval, és várja meg a kijelzőn az „OFF” jelzést. A „esc” „set” gombok együttes megnyomásával lépjen be a „U” paraméterekbe.</p>	
<p>Megjelenik a „PAr” paraméter. Nyomja meg a „set” gombot a belépéshez.</p>	
<p>Megjelenik a „CF9” paraméter. Nyomja meg a „set” gombot a belépéshez.</p>	
<p>Megjelenik az „A r” paraméter. A „>” és „<” gombokkal válassza ki az „UEr” paramétert.</p>	
<p>Nyomja meg a „set” gombot a belépéshez.</p>	
<p>A szoftver verziója látható</p>	
<p>Nyomja meg háromszor a „esc” gombot a kilépéshez.</p>	



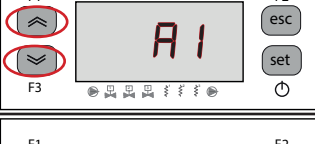

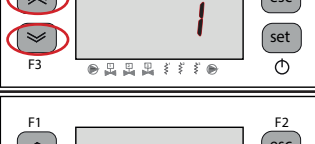



Felügyelet engedélyezése

<p>Kapcsolja be a hűtőt „ON” a QS főkapcsolóval, és várja meg a kijelzőn az „OFF” jelzést. A „esc” „set” gombok együttes megnyomásával lépjen be a „U” paraméterekbe.</p>	
<p>Megjelenik a „PAr” paraméter. Nyomja meg a „set” gombot a belépéshez.</p>	
<p>Megjelenik a „CF9” paraméter. Nyomja meg a „set” gombot a belépéshez.</p>	
<p>Megjelenik az „A r” paraméter. A „>” és „<” gombokkal válassza ki a „SUP” paramétert.</p>	
<p>Nyomja meg a „set” gombot a belépéshez.</p>	
<p>Az alapértelmezett érték „OFF” A módosításhoz használja a „>” és „<” gombokat.</p>	
<p>Nyomja meg a „set” gombot a megerősítéshez.</p>	
<p>A paraméter most már tárolásra került. Nyomja meg háromszor a „esc” gombot a kilépéshez.</p>	

Modbus (cím)

Kapcsolja be a hűtőt „ON” a QS főkapcsolóval, és várja meg a kijelzőn az „OFF” jelzést. A „esc” „set” gombok együttes megnyomásával lépjen be a „U” paraméterekbe.	
Megjelenik a „PAr” paraméter. Nyomja meg a „set” gombot a belépéshez.	
Megjelenik a „CF9” paraméter. Nyomja meg a „set” gombot a belépéshez.	
Megjelenik az „A1” paraméter. A „>” és „<” gombokkal válassza ki a „CF30” paramétert.	
Nyomja meg a „set” gombot a belépéshez.	
Az alapértelmezett érték „1” Használja a „>” és „<” gombokat a cím módosításához.	
Nyomja meg a „set” gombot a megerősítéshez.	
A paraméter most már tárolásra került. Nyomja meg háromszor a „esc” gombot a kilépéshez.	

Modbus (protokoll)

Kapcsolja be a hűtőt „ON” a QS főkapcsolóval, és várja meg a kijelzőn az „OFF” jelzést. A „esc” „set” gombok együttes megnyomásával lépjen be a „U” paraméterekbe.	
Megjelenik a „PAr” paraméter. Nyomja meg a „set” gombot a belépéshez.	
Megjelenik a „CF9” paraméter. Nyomja meg a „set” gombot a belépéshez.	
Megjelenik az „A1” paraméter. A „>” és „<” gombokkal válassza ki a „CF31” paramétert.	
Nyomja meg a „set” gombot a belépéshez.	
Az alapértelmezett érték „1” Használja a „>” és „<” gombokat a protokoll módosításához. (4.5.1. bekezdés - 3. táblázat)	
Nyomja meg a „set” gombot a megerősítéshez.	
A paraméter most már tárolásra került. Nyomja meg háromszor a „esc” gombot a kilépéshez.	

3. táblázat - Modbus protokoll (opcionális) (CF31)

1	PÁROS	2	NINCS	3	PÁRATLAN
---	-------	---	-------	---	----------

Modbus (Átviteli sebesség)

Kapcsolja be a hűtőt „ON” a QS főkapcsolóval, és várja meg a kijelzőn az „OFF” jelzést. A „esc” „set” gombok együttes megnyomásával lépjen be a „U” paraméterekbe.	
Megjelenik a „PAr” paraméter. Nyomja meg a „set” gombot a belépéshez.	
Megjelenik a „CF9” paraméter. Nyomja meg a „set” gombot a belépéshez.	
Megjelenik az „A1” paraméter. A „>” és „<” gombokkal válassza ki a „CF32” paramétert.	
Nyomja meg a „set” gombot a belépéshez.	
Az alapértelmezett érték „3” Használja a „>” és „<” gombokat az átviteli sebesség módosításához. (4.5.1. bekezdés - 4. táblázat)	
Nyomja meg a „set” gombot a megerősítéshez.	
A paraméter most már tárolásra került. Nyomja meg háromszor a „esc” gombot a kilépéshez.	

4. táblázat – Átviteli sebesség (opcionális) (CF32)

1	2400	3	9600	5	38400	7	115200
2	4800	4	19200	6	57600		

Megjegyzés: ha megváltoztatja a MODBUS paramétereket, az új paraméterek érvényesítéséhez ki kell kapcsolnia a hűtőt, majd újra be kell kapcsolnia.

ERD engedélyezése

Kapcsolja be a hűtőt „ON” a QS főkapcsolóval, és várja meg a kijelzőn az „OFF” jelzést. A „esc” „set” gombok együttes megnyomásával lépjen be a „U” paraméterekbe.	
Megjelenik a „PAr” paraméter. Nyomja meg a „set” gombot a belépéshez.	
Megjelenik a „CF9” paraméter. Nyomja meg a „set” gombot a belépéshez.	
Megjelenik az „A1” paraméter. A „>” és „<” gombokkal válassza ki az „ErD” paramétert.	
Nyomja meg a „set” gombot a belépéshez.	
Az alapértelmezett érték „OFF” A módosításhoz használja a „>” és „<” gombokat.	
Nyomja meg a „set” gombot a megerősítéshez.	
A paraméter most már tárolásra került. Nyomja meg háromszor a „esc” gombot a kilépéshez.	

Az ERD paraméter engedélyezésével: A víz beállított hőmérséklete a környezeti hőmérséklet függvényében változik. A funkció csak akkor aktív, ha a hőmérséklet precíziós szabályozása ki van kapcsolva (CPT=OFF).

4.6.2 Hőmérséklet-szabályozás „CNP”

Hőmérséklet-szabályozás beállítása

<p>Kapcsolja be a hűtőt „ON” a QS főkapcsolóval, és várja meg a kijelzőn az „OFF” jelzést.</p> <p>A „esc” „set” gombok együttes megnyomásával lépjen be a „U” paraméterekbe.</p>	
<p>Megjelenik a „PAR” paraméter.</p> <p>Nyomja meg a „set” gombot a belépéshez.</p>	
<p>Megjelenik a „CF9” paraméter.</p> <p>A „>” és „<” gombokkal válassza ki a „CNP” paramétert.</p>	
<p>Nyomja meg a „set” gombot a belépéshez.</p>	
<p>Megjelenik a „SEt” paraméter.</p> <p>Nyomja meg a „set” gombot a belépéshez.</p>	
<p>Az alapértelmezett érték „13.0”</p> <p>Használja a „>” és „<” gombokat az érték módosításához.</p>	
<p>Nyomja meg a „set” gombot a megerősítéshez.</p>	
<p>A paraméter most már tárolásra került.</p> <p>Nyomja meg háromszor a „esc” gombot a kilépéshez.</p>	

Fontos: A hőmérséklet 1 °C és 5 °C közötti beállítását szakképzett szakembereknek kell elvégezniük, akiknek a termék speciális szervizkönyvét kell használniuk.

Hőmérséklet-különbőség szabályozása

<p>Kapcsolja be a hűtőt „ON” a QS főkapcsolóval, és várja meg a kijelzőn az „OFF” jelzést.</p> <p>A „esc” „set” gombok együttes megnyomásával lépjen be a „U” paraméterekbe.</p>	
<p>Megjelenik a „PAR” paraméter.</p> <p>Nyomja meg a „set” gombot a belépéshez.</p>	
<p>Megjelenik a „CF9” paraméter.</p> <p>A „>” és „<” gombokkal válassza ki a „CNP” paramétert.</p>	
<p>Nyomja meg a „set” gombot a belépéshez.</p>	
<p>Megjelenik a „SEt” paraméter.</p> <p>A „>” és „<” gombokkal válassza ki a „d iF I” paramétert.</p>	
<p>Nyomja meg a „set” gombot a belépéshez.</p>	
<p>Az alapértelmezett érték „4.0”</p> <p>Használja a „>” és „<” gombokat az érték módosításához.</p>	
<p>Nyomja meg a „set” gombot a megerősítéshez.</p>	
<p>A paraméter most már tárolásra került.</p> <p>Nyomja meg háromszor a „esc” gombot a kilépéshez.</p>	

4.6.3 „bt 1” szondaparaméter

Szonda „bt 1”.

Kapcsolja be a hűtőt „ON” a QS főkapcsolóval, és várja meg a kijelzőn az „OFF” jelzést. A „esc” „set” gombok együttes megnyomásával lépjen be a „U” paraméterekbe.	
Megjelenik a „PAR” paraméter. Nyomja meg a „set” gombot a belépéshez.	
Megjelenik a „CF9” paraméter. A „<” és „>” gombokkal válassza ki a „bt 1” paramétert.	
Nyomja meg a „set” gombot a belépéshez.	
Megjelenik a „HA 1” paraméter. Nyomja meg a „set” gombot a belépéshez.	
Az alapértelmezett érték „50.0” Használja a „<” és „>” gombokat az érték módosításához.	
Nyomja meg a „set” gombot a megerősítéshez.	
A paraméter most már tárolásra került. Nyomja meg háromszor a „esc” gombot a kilépéshez.	

Ugyanez a szekvencia a „bt2” szonda esetében.

4.7 Vizualizációja szonda/ ventilátor/ Kompresszor

Hűtő működés közben. Nyomja meg a „>” gombot a szondák megtekintéséhez <i>bt 1, bt 2, bt 3, bP 1</i>	
Válassza ki a szondát, és várjon néhány másodpercet. (Pl. BT2)	
Megjelenik a bt 2 szonda értéke.	
Célszerű mindig visszatérni a bt 1 szondához	

Leírás:

bt 1 : kifolyó víz hőmérsékleti szonda
bt 2 : párologtató hőmérsékleti szonda
bt 3 : környezeti hőmérsékleti szonda
bt 10 : Elektromos panel hőmérsékleti szonda (opció)
bP 1 : 1. kör adója
bP 2 : 2. kör adója; (modelltől ICEP080)













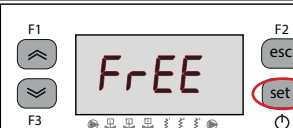

F_... : ventilátor működése:

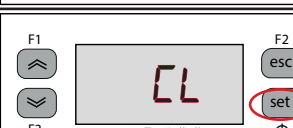
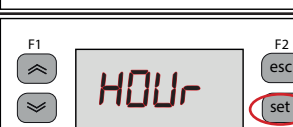
F_... : ventilátor KI
 F-... : ventilátor 1 BE, ventilátor 2,3 KI: (2 = modelltől ICEP022) (3 = modelltől ICEP080)
 F--... : ventilátor 1 és 2 BE, ventilátor 3 KI, (2 = modelltől ICEP022) (3 = modelltől ICEP080)
 F---... : ventilátor 1,2 és 3 BE (modelltől ICEP080)

IC2 : kompresszorok működése:

IC_... : kompresszorok letiltva
 IC-... : kompresszorok KI
 IC- : Kompresszor 1 BE, compressor 2 KI
 IC2 : kompresszorok 1 és 2 BE; (modelltől ICEP055)
 IC- : villogó „1”-es jelzéssel a kompresszor indításra kész, Kompresszor 2 KI

4.8 Óra/dátum beállítása

<p>Kapcsolja be a hűtőt „ON” a QS főkapcsolóval, és várja meg a kijelzőn az „OFF” jelzést.</p> <p>A „” és „” gombok együttes megnyomásával lépjen be a „Dátum/idő” menübe</p>	
<p>Megjelenik az „FrEE” paraméter.</p> <p>Nyomja meg a „set” gombot a belépéshez.</p>	
<p>Megjelenik az „A1” paraméter.</p> <p>A „” és „” gombokkal válassza ki a „CL” paramétert.</p>	
<p>Nyomja meg a „set” gombot a belépéshez.</p>	
<p>Megjelenik a „HOUr” paraméter.</p> <p>Nyomja meg 5 másodpercig a „set” gombot. Most a paraméter villog.</p>	
<p>A „” és „” gombokkal válassza ki a módosítandó dátumot, órát vagy évet.</p>	
<p>Nyomja meg a „set” gombot a belépéshez.</p>	
<p>Használja a „” és „” gombokat az érték módosításához (pl. év)</p>	
<p>Nyomja meg a „set” gombot a megerősítéshez.</p>	

Használja a „” és „” gombokat egy másik érték módosításához (pl. dátum)



Nyomja meg a „esc” gombot a kilépéshez. A paraméter nem villog tovább.











A „” „” gombok együttes megnyomásával lépjen ki.

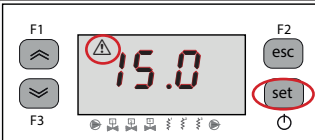

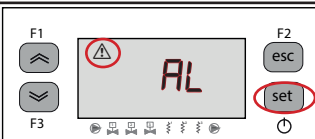
! Az „óra/dátum” memória maximális időtartama három nap, így ha a vezérlő három napnál hosszabb ideig áram nélkül marad, a beállított óra/hónap/év adatai elvesznek. Állítsa be az órát a gép indításakor, illetve amikor csak szükséges.

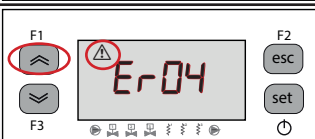
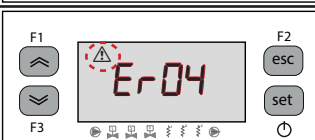



4.9 Riasztáskezelés

<p>Riasztás esetén a riasztás kódja és egy szimbólum jelenik meg a bal felső sarokban</p> <p> Folyamatos = riasztás jelen Villogó = figyelmeztetés jelen/ A riasztás visszaállítható</p>	
<p>Nyomja meg a „set” gombot a belépéshez.</p>	
<p>Megjelenik az „RLH” paraméter.</p> <p>A „” gombbal válassza ki a „RL” paramétert.</p>	
<p>Nyomja meg a „set” gombot a belépéshez.</p>	
<p>A riasztás kódja megjelenik, pl: „Er04”.</p> <p>Nyomja meg a „” gombot annak ellenőrzéséhez, hogy van-e még több riasztás.</p>	
<p>A visszaállítás elvégzése előtt javítsa ki a hibát.</p> <p>A hiba elhárítása után a riasztás szimbólum villogni kezd.</p> <p>Most már elvégezheti a visszaállítást.</p>	
<p>nyomja meg a „esc” gombot, amíg a riasztás el nem tűnik.</p>	

Riasztás/figyelmeztetés lista

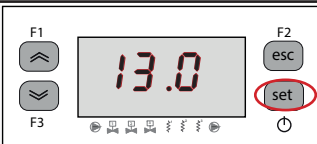
Kód	Leírás	Művelet	Visszaállítás
Er01	A bt1 érzékelő megszakítása vagy meghibásodása	Riasztás	M
Er02	A bt2 érzékelő megszakítása vagy meghibásodása	Riasztás	M
Er03	A bt3 érzékelő megszakítása vagy meghibásodása	Riasztás	A
Er05	A bt10 érzékelő megszakítása vagy meghibásodása	Riasztás	A
Er06	A bP1 érzékelő megszakítása vagy meghibásodása	Riasztás	M
Er08	Nagynyomású kapcsoló áramköre 1	Riasztás	M
Er09	Alacsonynyomású kapcsoló áramköre 1	Riasztás	M
Er12	Magas hőmérséklet bt1	Riasztás	M
Er13	Alacsony hőmérséklet bt1	Riasztás	A
Er14	Magas hőmérséklet bt2	Riasztás	M
Er15	Alacsony hőmérséklet bt2	Riasztás	M
Er16	Magas hőmérséklet bt3	Riasztás	A
Er17	Alacsony hőmérséklet bt3	Riasztás	A
Er18	Kompresszor hővédelme 1	Riasztás	M
Er20	Szivattyú hővédelme 1	Riasztás	M
Er22	Alacsony vízszint / nyomáskülönbség kapcsoló	Riasztás	M
Er23	Fázisfigyelő	Riasztás	M
Er24	Tárolási tartály meghibásodott vagy leválasztva	Riasztás	M
Er25	Kompresszor 1 üzemórái túllépve	Figyelmeztetés	M
Er27	Egység üzemórái túllépve	Figyelmeztetés	M
Er28	Óramemória	Figyelmeztetés	A
Er29	Hűtőkonfiguráció	Figyelmeztetés	A





4.10 Riasztási előzmények

Hűtő működés közben. Nyomja meg a „set” gombot a riasztási előzmények megtekintéséhez.	
Nyomja meg a „set” gombot a belépéshez.	
Használja a „>” és „<” gombokat a paraméterek megtekintéséhez. (4.5.5. bekezdés)	
Nyomja meg a „set” gombot az érték megtekintéséhez.	

5 Karbantartás

- A gép tervezése és megépítése úgy történt, hogy az biztosítsa a folyamatos működést; azonban az alkatrészek élettartama függ az elvégzett karbantartásuktól.
-  Amikor segítséget vagy alkatrészt kér, azonosítsa a gépet (modell és gyári szám) az egységen elhelyezett adattábláról. (www.polewr.com.)

5.1 Általános figyelmeztetések

-  Bármilyen karbantartási munka végzése előtt ellenőrizze, hogy a hűtő nincs-e feszültség alatt.
-  Mindig eredeti gyári alkatrészeket használjon: ellenkező esetben a gyártó nem felel a gép rendellenes működése esetén.
-  Ha a hűtőfolyadék szivárog, vegye fel a kapcsolatot felhatalmazott szakemberrel.
-  A Schrader szelep csak a gép rendellenes működése esetén használandó: ellenkező esetben a hibás hűtőfolyadék betöltés miatt bekövetkező károokra nem érvényes a garancia.

5.2 Hűtő













Feltöltési művelet: a fel nem hatalmazott személy által végzett helytelen feltöltés okozta esetleges károokra nem érvényes a garancia. 

-  A berendezés fluortartalmú üvegházhatású gázokat tartalmaz.
Az R513A hűtőfolyadék normál hőmérsékleten és nyomáson SAFETY GROUP A1 - EN378 biztonsági osztályba tartozó szintelen gáz (a PED 2014/68/EU irányelv szerinti 2. csoportba tartozó folyadék); GWP (Global Warming Potential) = 629.

-  Ha szivárog a hűtőfolyadék, szellőztesse ki a helyiséget.

5.3 Rendszeres karbantartási program

A folyadékűtő tartós maximális hatékonyságának és megbízhatóságának biztosításához végezze el az alábbi műveleteket:

Karbantartási tevékenység leírása	Karbantartás gyakorisága (standard működési feltételek mellett)			
	Daily	6 Months	12 Months	36 Months
Tevékenység ellenőrizze  szerviz 				
Ellenőrizze, hogy a POWER ON led égjen.				
Ellenőrizze a kezelőpanel kijelzőit.				
Tisztítsa meg a kondenzátor bordáit.				
Ellenőrizze az áramfelvételt.				
Ellenőrizze a hűtőfolyadék szivárgását.				
Ellenőrizze és Tisztítsa a Viz biztonsági szelep (ha van)*				
Ellenőrizze kapcsolószekrény elektromos rendszerét.**				
Ellenőrizze a hőmérsékletszondákat. Ha szükséges cserélje ki.				 
Karbantartás készlet				



Az alábbiak állnak rendelkezésre (lásd a 7. bekezdést):

- a) szervizkészletek: electrical kit; kompresszor készlet; ventilátor készlet; párologtató készlet; szivattyú készlet; víztartály készlet;
 b) vegyesen alkatrészek.

*A teljes hatékonyság biztosítása érdekében a biztonsági szelepeket rendszeresen ellenőrizni kell.

Idővel szennyeződések telepedhetnek meg a dugó közelében, ezért a szelepülés időszakos átöblítése szükséges. Az ilyen öblítés a szelep kézi leeresztésével érhető el, a gombnak a nyílak által jelzett irányba történő elfordításával.

Fontos: E művelet után győződjön meg arról, hogy az üzemi nyomás helyreállt.

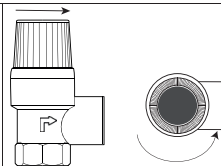



** Az időszakos karbantartási műveletek során a gép és a kapcsolószekrény elektromos rendszerét is ellenőrizni kell a helyi előírások követelményei szerint. Továbbá, ha ez megoldható, az elektromos berendezéseket és az elektromos vezetőköt is meg kell vizsgálni szemrevételezéssel, és ellenőrizni

kell, hogy az elektromos alkatrészek vezetékeinek csatlakozó sorkapcsai a kapcsolási rajzon megadott nyomatékkal lettek-e meghúzva.

5.4 Semlegesítés

A hűtőfolyadékot és a rendszerben lévő kenőolajat az érvényes helyi környezetvédelmi előírásoknak megfelelően kell begyűjteni.

A hűtőfolyadék visszanyerését a készülék végleges megsemmisítése előtt kell elvégezni (517/2014/EU 8 cikk)..

	ÚJRAHASZNOSÍTÁS MEGSEMMISÍTÉS 
fém szerkezet	acél/epoxi-poliészter gyanták
tartály	alumínium/vörösréz/acél
csővezetékek/kollektorok	vörösréz/alumínium/szénacél
csövek szigetelése	nitrul gumi (NBR)
kompresszor	acél/vörösréz/alumínium/olaj
kondenzátor	acél/vörösréz/alumínium
szivattyú	acél/öntvény/sárgaréz
ventillátor	alumínium
hűtőfolyadék	R513A
szelepek	sárgaréz/vörösréz
elektromos vezetékek	vörösréz/PVC

Az elektromos alkatrészeket tartalmazó berendezéseket a helyi és a hatályos jogszabályok szerint az elektromos és elektronikus hulladékkal együtt kell elhelyezni.



6 Hibakeresés

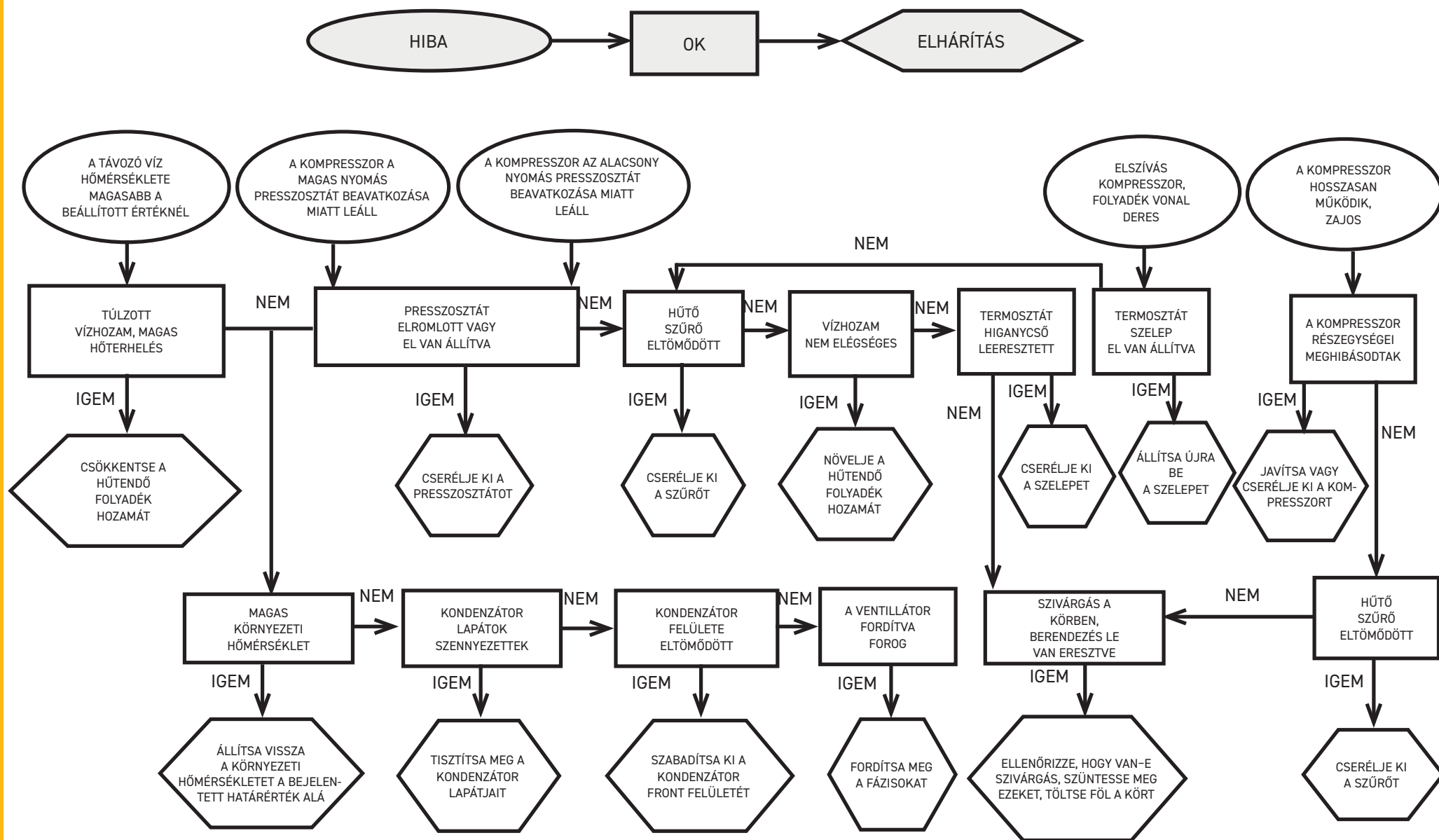



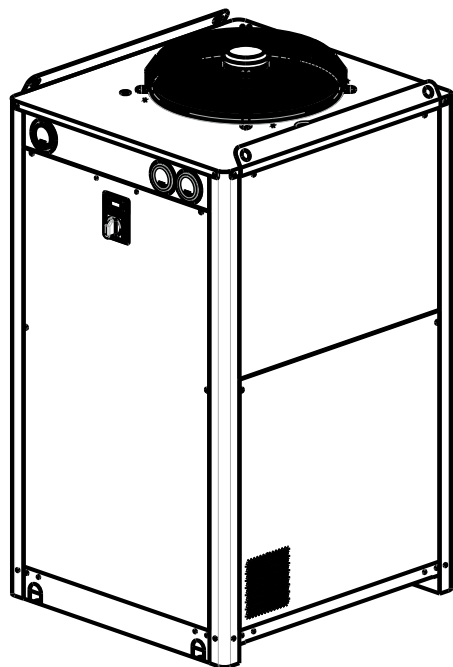
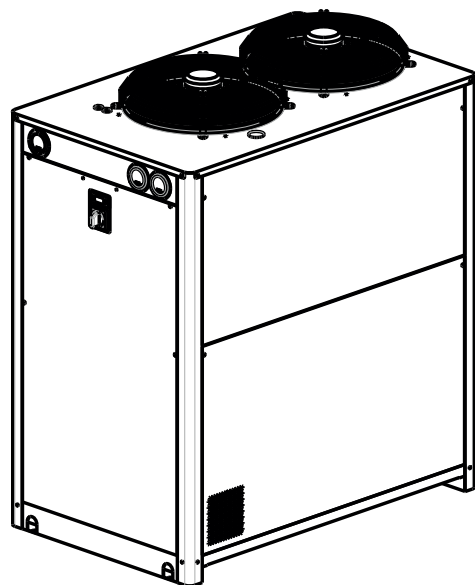

Appendice
 Anhang
 Apéndice
 Appendix
 Appendice
 Bilaga
 Liittet
 Tillæg
 Anexo
 Bijlage
 Appendiks
 Aneks
 Příloha
 Tartalom









CONTENTS

7.1 Legend	2
7.2 Installation diagram.....	11
7.3 Handling, operating space	13
7.4 Technical data	14
Ecodesign requirements.....	15
Modbus.....	17
7.5 Dimensional drawings ICEP008-015E (air cond. A)	21
Dimensional drawings ICEP022E (air cond. A).....	22
Dimensional drawings ICEP027E (air cond. A).....	23
Dimensional drawings ICEP022-27E (water cond. W).....	24
Dimensional drawings - External tank	25
7.6 Spare parts	26
7.7 Exploded drawing ICEP008-011-015E	28
Exploded drawing ICEP022E	29
Exploded drawing ICEP027E	30
7.8 Circuit Diagram ICEP008-015E (air cond. A)	31
Circuit Diagram ICEP022E (air cond. A)	32
Circuit Diagram ICEP027E (air cond. A)	33
Circuit Diagram ICEP022E (water cond. W)	34
Circuit Diagram ICEP027E (water cond. W)	35
7.9 Wiring diagram ICEP008-015E (standard)	36
Wiring diagram ICEP022-027E (standard)	47
Wiring diagram ICEP008-015E (with option).....	58
Wiring diagram ICEP022-027E (with option).....	73
Wiring diagram ICEP008-015E (Fan speed option)	88
Wiring diagram ICEP022-027E (Fan speed option)	103

7.1 Legend

Simbol	IT/DE/ES/EN	FR/SV/FI/DA	PT/NL/NO/PL	CS/HU/
A	Versione condensato ad aria (ventilatori assiali) Version mit Luftkondensation (Axialventilatoren) Versión condensado por aire (ventiladores axiales) Air-cooled version (axial fans)	Version condensation à air (ventilateurs axiaux) Maskinversion med luftkondensation (axialfläktar) Ilmalauhdutusmalli (aksiaalipuhaltimet) Model med luftkondensering (aksiale ventilatorer)	Versão com condensador de ar (ventiladores axiais) Uitvoering met luchtcondensatie (axiale ventilatoren) Versjon med luftkondensasjon (aksialvifter) Wersja z kondensowaniem za pomocą powietrza (wentylatory osiowe)	Verze s kondenzací vzduchem (axiální ventilátory) Légkondenzációs változat (tengelyes ventilátorok)
LAT	Opzione bassa temperatura ambiente Option niedrige Aumentemperatur Opción baja temperatura ambiente Low ambient temperature option	Option basse température ambiante Valmöjlighet - låg omgivningstemperatur Matalan ympäristön lämpötilan vaihtoehto Model til lave omgivelsestemperaturer	Opção de baixa temperatura ambiente Optie lage omgevingstemperatuur Valg ved lav omgivelsestemperatur Opcja niskiej temperatury otoczenia	Funkce nízká teplota prostředí Alacsony környezeti hőmérsékleti opció
NP	Opzione no pompa Option Pumpe aus Opción sin bomba No pump option	Option sans pompe Valmöjlighet - utan pump Ilman pumppua oleva vaihtoehto Model uden pumpe	Opção sem bomba Optie geen pomp Valg av ingen pumpe Opcja bez pompy	Funkce bez čerpadla Szivattyú nélküli opció
AH	Opzione resistenza antigelo Option Frostschutzwiderstand Opción resistencia antihielo Antifreeze heating element option	Option résistance antigel Valmöjlighet - frostbeständig Jäätymisenestovaihtoehto Model med antifrostmodstand	Opção de resistência anti-gelo Optie vorstwerende weerstand Valg av antifrostelement Opcja wytrzymała na zamarzanie	Funkce topného článku proti mrazu Fagymentesítő ellenállás opció
 Kg	Peso Gewicht Peso Weight	Poids Vikt Paino Vægt	Peso Gewicht Vekt Ciężar	Váha Súly
 Amb	Temperatura ambiente Umgebungstemperatur Temperatura ambiente Ambient temperature	Température ambiante Omgivningstemperatur Ympäristön lämpötila Rumtemperatur	Temperatura ambiente Omgevingstemperatuur Omgivelsestemperatur Temperatura otoczenia	Teplota prostředí Környezeti hőmérséklet
	Durante trasporto & immagazzinaggio Während Transport & Lagerung Durante el transporte y el almacenamiento During transport and stockage	Pendant le transport et l'entreposage Under transport och magasinering Kuljetuksen ja varastoinnin aikana Under transport og opmagasinering	Durante o transporte e armazenamento Tijdens transport & opslag Under transport og lagring Podczas transportu & magazynowania	Během dopravy a skladování Szállítás és raktározás idején
	Dopo l'installazione Nach der Installation Tras la colocación After installation	Après l'installation Efter installationen Asennuksen jälkeen Efter installationen	Após a instalação Na installatie Efter installasjon Po instalacji	Po instalaci Felszerelés után
	Ingresso acqua Wassereinlauf Entrada de agua Water inlet	Entrée d'eau Vattenintag Veden syöttö Vandindgang	Entrada de água Wateringang Vanninntak Wejście wody	Vstup vody Víz bemenet

7.1 Legend

Simbol	IT/DE/ES/EN	FR/SV/FI/DA	PT/NL/NO/PL	CS/HU/
	Uscita acqua Wasserauslauf Salida de agua Water outlet	Sortie d'eau Vattenavlopp Veden poisto Vandudgang	Saída de água Wateruitgang Vannavløp Ujście wody	Výstup vody Víz kimenet
	Carico/Scarico acqua Wasserablass /Wasserlast Carga/Descarga del agua Water charge / drain	Recharger / Evacuation eau Vattenbelastningen Vattenavlopp Veden kuormitus / tyhjennys Vand belastning / Vandafløb	Carregamento / Descarga da água Waterbelasting / Waterafvoer Vann belastning / Vannutførsel Obciążenie / Odprowadzanie wody	Plnění / Vypouštění vody Vízfeltöltő / Vízelvezetés
	Livello pressione sonora (a 10 m di distanza in campo libero, secondo norma ISO 3746) Schalldruckpegel (in 10 m Abstand auf freiem Feld) (gemäß ISO-Norm 3746). Nivel de presión sonora (distancia de 10m al aire libre - según la ISO 3746) Sound pressure level (10m distance in free field - according to ISO 3746).	Niveau de pression sonore à 10 mètre de distance en champ libre (selon norme ISO 3746). Ljudtrycksnivå (på 10 meters avstånd, i fritt fält (enligt standard ISO 3746). Äänenpainetaso (10 metrin etäisyydellä vapaassa tilassa, standardin ISO 3746 mukaisesti). Lydtryksniveau i 10 meters afstand på frit område (iflg. normen ISO 3746).	Nível de pressão sonora (a 10 metro de distância em campo aberto (segundo a norma ISO 3746). Geluidsniveau (op 10 meter afstand in het vrije veld (volgens norm ISO 3746). Lydtrykksnivå (på 10 meters distanse i åpent rom (iht. standarden ISO 3746). Poziom cieniienia akustycznego (w odległości 10 metr w wolnym polu, według normy ISO 3746).	Hladina zvukového tlaku (ve vzdálenosti 10 m ve volném prostoru, podle normy ISO 3746). Hangnyomás szint (szabad területen 1 méteres távolságban az ISO 3746 szabvány szerint).
% gly	% glicole % Glykole Porcentaje de glicol % glycols	% glycole % glykol glykoliprosentti % glykol	% de glicol % glycol % glykol % glikol	% glykolu % glikol
Max 	Massima pressione di esercizio lato aria Max. Betriebsdruck auf Druckluftseite Presión de trabajo máx. del lado del aire Air-side max. working pressure	Pression maximum d'utilisation côté air Maximalt drifttryck på luftsidan Maksimi toimintapaine ilman puolella Maks. driftstryk på luftsidan	Pressão máxima de funcionamento do lado do ar Maximale bedrijfstemperatuur luchtzijde Maks. driftstrykk luftside Maksymalne ciśnienie robocze po stronie powietrza	Maximální provozní tlak strana vzduchu Levegő oldal maximális üzemi nyomás
	Valori di taratura Einstellwerte Valores de calibración Calibration values	Valeurs de réglage Inställningsvärden Säätöarvot Justeringsværdier	Valores de calibragem Instelwaarden Innstillingsverdier Wartości kalibracji	Hodnoty kalibrace Beállítás szerinti értékek
	centro di gravità centro de gravedad Gravitationszentrum centre of gravity	centre de gravité tyngdpunkt painopiste tyngdepunkt	centro de gravidade zwaartepunt tyngdepunkt Środek ciężkości	téžiště súlypont

7.1 Legend

Simbol	IT/DE/ES/EN	FR/SV/FI/DA	PT/NL/NO/PL	CS/HU/
0	Sezione minima cavo omologato per collegamento elettrico Mindestquerschnitt des typengeprüften Kabels für elektrischen Anschluss Cable de sección mínima validado para la conexión eléctrica. Minimum section validated cable for electrical connection.	Section minimale câble homologué pour le raccordement électrique. Minstatvärnsnittförgodkänd kabel för elektrisk anslutning. Sähköliitännän hyväksytyn kaapelin minimihalkaisija. Minimumssnit for kabel godkendt til eltilslutning	Secção mínima do cabo homologado para a ligação eléctrica. Minimumdoorsnede goedgekeurde kabel voor elektrische aansluitingen. Min. snitt på forskriftsmessig kabel for elektrisk tilkobling. Przekrój minimalny kabla z homologacją do podłączeń elektrycznych.	Minimální průřez homologovaného kabelu pro připojení k elektrické síti Elektromos bekötésre engedélyezett vezeték minimális keresztmetszete.
IP	Grado di protezione Schutzart Grado de protección Protection degree	Degré de protection Skyddsgrad IP-suojausaste Beskyttelsesgrad	Grau de protecção Beschermingsgraad Beskyttelsesgrad Stopień ochrony	Stupeň ochrany Védettségi fok
▲ ▲ ▲	Uscita aria di condensazione Austritt Kondensationsluft Salida aire de condensación Condensation air outlet	Sortie air de condensation Utlopp för kondensluft Lauhdeilman poisto Udgang kondenseringsluft	Saída do ar de condensação Uitgang condenslucht Utgang kondensasjonsluft Wylot powietrza kondensacyjnego	Výstup kondenzovaného vzduchu Kondenzlevegő kimenet
△ △ △	Ingresso aria di condensazione Eintritt Kondensations Entrada aire de condensación Condensation air inlet	Entrée air de condensation Intag för kondensluft Lauhdeilman syöttö Indgang kondenseringsluft	Entrada do ar de condensação Ingang condenslucht Inngang kondensasjonsluft Wlot powietrza kondensacyjnego	Vstup kondenzovaného vzduchu Kondenzlevegő bemenet
	Ingresso alimentazione elettrica Eingang elektrische Versorgung Entrada del suministro eléctrico Electrical supply inlet	Entrée alimentation électrique Intag för strömförsörjning Sähkösyöttö Indgang elforsyning	Entrada da alimentação eléctrica Ingang elektrische voeding Inngang elektrisk strømtilførsel Wejocie zasilania elektrycznego	Vstup elektrického napájení Villamos táp bemenet
----- --	Opzionale Optional Opcional Optional	Option Tillval Valinnainen Optional	Opcional Optioneel Valgfritt Opcjonalnie	Voliteľné Opcionális
-----	Límite dell'apparecchiatura Grenze der Einheit Límite del equipo Limit of equipmen	Limite de l'appareil Apparatens gräns Laitteiston raja Apparaturets begrænsning	Limite do aparelho Limieten van de apparatuur Apparatgrense Limit przyrządu	Limit zařízení A berendezés határa
① MC1	Compressore Verdichter Compresor Compressor	Compresseur Kompressor Kompressori Kompressor	Compressor Compressor Kompressor Sprężarka	Kompresor Kompresszor

7.1 Legend

Simbol	IT/DE/ES/EN	FR/SV/FI/DA	PT/NL/NO/PL	CS/HU/
②	Condensatore refrigerante Kältemittelkondensator Condensador refrigerante Refrigerant condenser	Condenseur réfrigérant Kylkondensator Jäähdetyskondensaattori Kølekondensator	Condensador refrigerante Condensator koelvløiestof Kjølerkondensator Kondensator czynnika chłodniczego	Kondenzátor chladivo Hűtő kondenzátor
③ EV	Elettroventilatore Elektroventilator Motor del ventilador Fan motor	Électroventilateur Elfläkt Sähköpuhallin Elektroventilator	Ventilador eléctrico Elektroventilator El-vifte Elektrowentylator	Elektrický ventilátor Elektromos ventillátor
④	Filtro refrigerante Kältemittelfilter Filtro refrigerante Refrigerant filter	Filtre réfrigérant Kylmedelsfilter Jäähdetyssuodatin Kølefilter	Filtro refrigerante Filter koelvløiestof Kjølemiddelfilter Filtr czynnika chłodniczego	Filtr chladiva Hűtő szűrő
⑤	Valvola espansione Expansionsventil Válvula de expansión Expansion valve	Vanne d'expansion Expansionsventil Paisuntaventtiili Ekspansionsventil	Válvula de expansão Expansieklep Ekspansjonsventil Zawór rozprężny	Ventil expanze Tágulási szelep
⑥	Scambiatore a piastre - evaporatore Plattenwärmetauscher - Verdampfer Intercambiador de placas - Evaporador Plate type heat exchanger - evaporator	Échangeur à plaques - Évaporateur Värmeväxlare med plattor - Förångare Laattatyyppinen vaihdin - Haihdutin Pladevarmeveksler - Fordamper	Permutador por placas - Evaporador Platenwarmtewisselaar - Verdampfer Varmeveksler med plater - Fordamper Wymiennik płytowy - Parownik	Deskový výměník - Výparník Lemezes hőcserélő - Párolgató
⑦ P	Pompa Pumpe Bomba Pump	Pompe Pump Pumppu Pumpe	Bomba Pomp Pumpe Pompa	Čerpadlo Szivattyú
⑧	Serbatoio acqua Wassertank Depósito de agua Water tank	Réservoir eau Vattentank Vesisäiliö Vandtank	Reservatório de água Watertank Vanntank Zbiornik wody	Nádržka s vodou Vízartály
⑨	Valvola di scarico acqua Wasser-Ablassventil Válvula de drenaje de agua Water drain valve	Soupape de décharge de l'eau Vattentömningsventil Vedenpoistiventtiili Vandudtømningsventil	Válvula de descarga da água Wateruitlaatklep Vanndreneringsventil Zawór spustu wody	Vypouštěcí ventil voda Víz leeresztőszelep
⑩	Sfiato aria Entlüftung Salida de aire Air-hole	Évacuation de l'air Luftningshål Ilmareikä Udluftningshul	Descarga de ar Ontluchtingsopening Ventilasjonsåpning Parownik	Odvzdušnění Légtelenítés
⑪	Manometro acqua Wasser-Manometer Manómetro del agua Water manometer	Manomètre eau Vattenmanometer Vedenpainemittari Vandmanometer	Manómetro de água Manometer water Vanndreneringsventil Manometr wody	Tlakoměr vody Víz nyomásmérő

7.1 Legend

Simbol	IT/DE/ES/EN	FR/SV/FI/DA	PT/NL/NO/PL	CS/HU/
12	Presa di pressione Druckanschluss Conexión de presión Pressure connection	Câble alimentation électrique Tryckuttag Imupaine Trykkudgang	Tomada de pressão Drukafnamepunt Trykkuttak Końcówka rury tłocznej	Měřicí hrdlo tlaku Nyomásmérő hely
13	Sonda temperatura acqua in uscita Temperatursensor für Wasser am Auslauf Sonda de temperatura del agua de salida Water outlet temperature sensor	Sonde température eau en sortie Temperatursond för utloppsvatten Poistuvan veden lämpötila-anturi Temperaturføler i vandudløb	Sonda da temperatura da água de saída Temperatuursonde afvoerwater Luftrykksmålere Sonda temperatury wody na wyjściu	Sonda teploty vody na výstupu Kifolyó víz hőmérsékleti szonda
14	Sonda temperatura evaporatore Temperatursensor Verdampfer Sonda de temperatura del evaporador Evaporator temperature sensor	Sonde température évaporateur Evaporatortemperatursond Haihduttimen lämpötila-anturi Fordamperens temperaturføler	Sonda da temperatura do evaporador Temperatuursonde verdamper Temperatursensor fordamper Sonda temperatury parownika	Sonda teploty výměníku Párolgató hőmérsékleti szonda
15	Sensore livello acqua Wasser-Füllstandsensor Sensor de nivel de agua Water level sensor	Capteur niveau eau Vattennivåsensor Vedenpinta-anturi Føler for vandniveau	Sensor do nível de água Sensor waterpeil Vannivå-sensor Czujnik poziomu wody	Čidlo hladiny vody Vízszint érzékelő
16 A1	Controllo elettronico Steuerelektronik Control electrónico Electronic control	Contrôle électronique Elektronisk kontroll Elektroniikkaohjus Elektronisk kontrol	Controlo electrónico Elektronische controle Temperatursensor i vannavløp Sterowanie elektroniczne	Elektronické ovládání Elektronikus vezérlés
17	Pressostato differenziale acqua Wasser-Differenzdruckschalter Presostato diferencial de agua Differential water pressure switch	Pressostat différentiel eau Differenstryckvakt för vatten Veden differentiaalain painekeytkin Pressostat for vanddifferentiale	Pressostato de diferencial de água Differentiële drukschakelaar water Differensialpressostat for vann Presostat wody	Diferenční presostat vody Víz differenciál presszosztát
18	Pressostato alta pressione Hochdruckwächter Presostato de alta presión High pressure switch	Pressostat haute pression Högtrycksvakt Korkean paineen painekeytkin Højtrykspresostat	Pressóstato de alta pressão Hogedrukschakelaar Høytrykkspressostat Presostat wysokiego ciśnienia	Presostat vysokého tlaku Nagynyomású presszosztát
19	Pressostato bassa pressione Niederdruckwächter Presostato baja presión Low pressure switch	Pressostat basse pression Lågtrycksvakt Matalapaineen painekeytkin Lagedrukschakelaar	Pressóstato de baixa pressão Lavtrykkspressostat Matalapaineen painekeytkin Presostat niskiego cioenienia	Presostat vysokého tlaku Alacsony nyomású presszosztát
20	Manometro aspirazione refrigerante Manometer auf Kältemittel---Saugseite Manómetro entrada refrigerante Refrigerant suction manometer	Manomètre aspiration réfrigérant Kylvätskeinloppsmanometer Jäähdytysaineen imupainemittari Kølemiddelsugemanometer	Manómetro de aspiração de refrigerante Manometer aanzuiging koelmiddel Kjølemiddel-sugemanometer Manometr na wlocie czynnika chłodniczego	Tlakoměr nasávání chladiva Hűtőfolyadék elszívás nyomásmérő
21	Manometro mandata refrigerante Manometer auf Kältemittel---Druckseite Manómetro salida refrigerante Refrigerant discharge manometer	Manomètre refoulement réfrigérant Kylvätskeutloppsmanometer Jäähdytysaineen syötön painemittari Kølemiddeltrykmanometer	Manómetro de descarga de refrigerante Manometer afgifte koelmiddel Kjølemiddel-trykmanometer Manometr na doprowadzeniu czynnika chłodniczego	Tlakoměr náběhu chladiva Hűtőfolyadék odairány nyomásmérő

7.1 Legend

Simbol	IT/DE/ES/EN	FR/SV/FI/DA	PT/NL/NO/PL	CS/HU/
22	Elettrovalvola gas caldo 1 Heißgas-Magnetventil 1 Electroválvula del gas caliente 1 Hot gas solenoide valve 1	Électrovanne gaz chaud 1 Elektromagnetisk ventil för varm gas 1 Kuuman kaasun magneettiventtiili 1 Magnetventil for varm gas 1	Electroválvula de gás quente 1 Elektromagnetische klep warm gas 1 Magnetventil for varmgass 1 Elektrozawór gazu gorącego 1	Elektrický ventil teplý plyn 1 Meleg gáz 1-es elektromos szelepe 1
23	Elettrovalvola gas caldo 2 Heißgas-Magnetventil 2 Electroválvula del gas caliente 2 Hot gas solenoide valve 2	Électrovanne gaz chaud 2 Elektromagnetisk ventil för varm gas 2 Kuuman kaasun magneettiventtiili 2 Magnetventil for varm gas 2	Electroválvula de gás quente 2 Elektromagnetische klep warm gas 2 Magnetventil for varmgass 2 Elektrozawór gazu gorącego 2	Elektrický ventil teplý plyn 2 Meleg gáz 1-es elektromos szelepe 2
24	Spia di flusso Durchflussanzeige Mirilla de flujo Sight glass	Témoin de débit Flödeskontrollampa Virtausvahti Gennemløbssignallampe	Luz de fluxo Controle toevoer Seglass Wskaźnik świetlny przepływu	Kontrolka průtoku Áramlás led
25	Trasduttore alta pressione HochDrucktransduktor Transmisor de alta presión High pressure transmitter	Transmetteur haute pression Högtrycks sändaret Korkeapaine lähetin Høj tryktransmitter	Transmissor de alta pressão Hoge druktransmitter Høy trykktransmitter Przetwornik wysokociśnieniowy	Vysokotlaký Převodník Ventilátor presszosztát
26	Sonda temperatura ambiente Aumentemperaturfühler Sonda temperatura ambiente Ambient temperature sensor	Sonde température ambiante Sond för omgivningstemperatur Ympäristön lämpötila-anturi Temperaturføler for omgivelsestemperatur	Sonda da temperatura ambiente Voeler omgevingstemperatuur Omgivelsestemperaturføler Sonda temperatury otoczenia	Sonda teploty prostředí Környezeti hőmérsékleti szonda
28	Valvola di non ritorno kein Rücklaufventil válvula sin retorno No return valve	Vanne de non-retour backventil takaiskuventtiili kontraventil	válvula anti-retorno terugslagklep tilbakeslagsventil zawór zwrotny	zpětný ventil visszacsapó szelep
WPV 29	Valvola pressostatica acqua Wasserpressostat Válvula presostática agua Water pressostatic valve	Vanne pressostatique à eau Pressostatventil vatten Vesi pressostaattinen venttiili Vandpressostat	Válvula pressostática água Drukschakelaarklep water Trykkstatisk vannventil Zawór presostatyczny wodą	Presostatický ventil voda Víz presszosztát szelep
30	Valvola di sicurezza acqua Wasser Sicherheitsventil Válvula de seguridad de agua Water safety valve	Soupape de sûreté à eau Säkerhetsventil vatten Varoventtiili Vesi Vand Sikkerhedsventil	Válvula de segurança água Veiligheidsklep water Sikkerhetsvannventil Zawór bezpieczeństwa wody	Pojistný ventil voda Víz biztonsági szelep
QS	Interruttore sezionatore generale Hauptschalter Interruptor seccionador general Main disconnect switch	Interrupteur sectionneur général Allmän frånskiljare Päävirtakatkaisin Hovedafbryder	Interruptor seccionador geral Algemene scheidingschakelaar Hovedbryter Główny wyłacznik sekcyjny	Hlavní úsekový vypínač Szakasoló főkapcsoló

7.1 Legend

Simbol	IT/DE/ES/EN	FR/SV/FI/DA	PT/NL/NO/PL	CS/HU/
QF1	Interruttore automatico compressore/ventilatore/pompa Automatischer Schutzschalter Kompressor/Ventilator/Pumpe Interruptor automático compresor/ventilador/bomba Automatic compressor/fan/pump switch	Interrupteur automatique compresseur/ventilateur/pompe Skyddsströmställare kompressor/fläkt/pump Automaattinen kytkin kompressori/tuuletin/pumppu Automatisk afbryder til kompressor/ventilator/pumpe	Interruptor automático do compressor/ventilador/bomba Automatische schakelaar compressor/ventilator/pomp Automatisk bryter for kompressor/vifte/pumpe Wyłącznik automatyczny sprężarki/wentylatora/pompy	Automatický vypínač kompresoru/ventilátoru/čerpadla Kompresszor/ventilátor/szivattyú automatikus megszakító
TC1	Trasformatore ausiliari Transformator Steuervorrichtungen Transformador auxiliares Auxiliary transformer	Transformateur auxiliaires Transformator till hjälpkretsar Apumuunnin Transformator for hjælpefunktioner	Transformadores auxiliares Hulptransformator Hjelpetransformatorer Transformator urządzeń pomocniczych	Transformátor pomocná zařízení Segédtranszformátorok
KM1	Contattore compressore Kontaktglied Verdichter Contactor compresor Compressor contactor	Contacteur compresseur Kompressorns kontaktdon Kompressorin kontaktori Kontaktfor kompressor	Contacteur do compressor Urenteller compressor Kompressorkontaktor Licznik sprężarki	Stykač kompresoru Kompresszor csatlakozó
KM5	Contattore ventilatore Kontaktglied Ventilator Contactor ventilador Fan contactor	Contacteur ventilateur Fläktens kontaktdon Puhaltimen kontaktori Kontaktfor ventilator	Contacteur do ventilador Urenteller ventilator Viftekontaktor Licznik wentylatora	Stykač ventilátoru Ventillátor csatlakozó
KM7	Contattore pompa Kontaktglied Pumpe Contactor bomba Pump contactor	Contacteur pompe Pumpkontaktor Puhaltimen kontaktori Pumpens kontaktor	Contacteur da bomba Contactgeber pomp Pumpekontaktor Stycznik pompy	Stykač čerpadla Szivattyú kontaktor
FV1	Monitore di fase Phasenmonitor Monitor de fase Phase monitor	Moniteur de phase Fasmonitor Vaiheen tarkistus Fasemonitor	Monitor di fase Fasebewaker Fasemonitor Monitor fazy	Monitor fáze Fázismonitor
Ecod.	Regolamento (EU) N.2016/2281 dei chiller di processo ad alta temperatura Verordnung (EU) 2016/2281 Prozesskühler mit hoher Betriebstemperatur Reglamento (EU) N.2016/2281 de las enfriadoras de procesos de alta temperatura Regulation (EU) N.2016/2281 for high temperature process chiller.	Règlement (UE) 2016/2281 , aux refroidisseurs industriels haute température Kommissionens förordning (EU) 2016/2281 processkylaggregat av högtemperaturtyp Kommissionen asetusa (EU) 2016/2281 korkeissa lämpötiloissa käytettävien prosessien jäähdytyslaitteiden ekologisen suunnittelun vaatimuksista Kommissionens forordning (EU) 2016/2281 , HT-chillers til proceskøling	Reglamento (UE) 2016/2281 dos refrigeradores de processo de alta temperatura Verordening (EU) 2016/2281 hogetemperatuurproces-chillers Rozporządzenie komisji (UE) 2016/2281 wysokotemperaturowych agregatów chłodniczych i klimakonwektorów	Nařízení komise (EU) 2016/2281 vysokoteplotních procesních chladičů (EU) 2016/2281 Rendelete a magas hőmérsékletű technológiai hűtők
t	Temperatura di esercizio Betriebstemperatur Temperatura de funcionamiento Operating temperature	Température de service Driftstemperatur Käyttölämpötila Driftstemperatur	Temperatura de funcionamento Bedrijfstemperatuur Temperatura robocza	Provozní teplota Üzemi hőmérséklet

7.1 Legend

Simbol	IT/DE/ES/EN	FR/SV/FI/DA	PT/NL/NO/PL	CS/HU/
Q	Consumo annuale di energia elettrica Jahresstromverbrauch Consumo anual de electricidad Annual electricity consumption	Consommation annuelle d'électricité Årlig elförbrukning Vuotuinen sähkönkulutus Årligt elförbruk	Consumo anual de eletricidade Jaarlijks elektriciteitsverbruik Roczne zużycie energii elektrycznej	Roční spotřeba elektrické energie Éves villamosenergia-fogyasztás
SERP	Indice di prestazione energetica stagionale Jahresarbeitszahl Factor de rendimiento energético estacional Seasonal energy performance ratio	Ratio de performance énergétique saisonnier Säsongsfaktor för energiprestanda Vuotuinen energiatehokkuuskerronin Säsongenergieeffektivitetsfaktor	Rácio de desempenho energético sazonal Seizoensgebonden energieprestaties Współczynnik sezonowej sprawności energetycznej	Koeficient sezónní energetické účinnosti Szezonális hűtési jóságfok
	Parametri a pieno carico e alla temperatura ambiente al punto di valutazione Parameter bei Volllast und Bezugsumgebungstemperatur am Bewertungspunkt Parâmetros a plena carga y a temperatura ambiente de referencia en el punto de clasificación Parameters at full load and ambient temperature	Paramètres à pleine charge et à la température ambiante de référence au point d'évaluation Parametrar vid fullast och referensomgivningstemperatur vid bedömningspunkt Parametrit täydellä kuormituksella ja vertailulämpötilassa mittauspisteessä Parametre ved fullast og referenceomgivelsestemperatur ved målepunkt	Parâmetros à carga total e no ponto de referência de temperatura ambiente de referência Parameters bij vollast en referentieomgevingstemperatuur op punt Parametry przy pełnym obciążeniu i referencyjnej temperaturze otoczenia w punkcie znamionowym	Parametry při plném zatížení a referenční okolní teplotě ve jmenovitém bodě Paraméterek teljes terhelés mellett, környezeti referencia-hőmérsékleten
P_A	Capacità di refrigerazione nominale Nennkälteleistung Potencia nominal de refrigeración Rated refrigeration capacity	Puissance de réfrigération nominale Nominell kylkapacitet Nimellinen kylmäteho Nominel kuldeydelse	Potência de refrigeração nominal Nominaal koelvermogen Znamionowa wydajność chłodnicza urządzeń przemysłowych	Jmenovitý výkon chlazení Mért technológiai hűtőteljesítmény
D_A	Potenza nominale assorbita Nennleistungsaufnahme Potencia utilizada nominal Rated power input	Puissance absorbée nominale Nominell tillförd effekt Nimellinen ottoteho Nominelt effektoptag	Potência nominal de entrada Nominaal opgenomen vermogen Znamionowy pobór mocy	Jmenovitý příkon Mért felvett elektromos teljesítmény
EER_{DC,A}	Indice di efficienza energetica nominale Nennleistungszahl Factor de eficiencia energética nominal Rated energy efficiency ratio	Coefficient d'efficacité énergétique nominal Nominell köldfaktor Nimelliskylmäterroin Nominel energieeffektivitetsfaktor	Rácio de eficiência energética nominal Nominale energie-efficiëntieverhouding Znamionowy wskaźnik efektywności energetycznej	Jmenovitý chladicí faktor Mért hűtési jóságfok
P_{B/C/D}	Capacità dichiarata di refrigerazione Angegebene Kälteleistung Potencia de refrigeración declarada Declared refrigeration capacity	Puissance de réfrigération déclarée Deklarerad kylkapacitet Ilmoitettu kylmäteho Oplyst kuldeydelse	Potência de refrigeração declarada Opgegeven koelvermogen Peklarowana wydajność chłodnicza urządzeń przemysłowych	Deklarovaný výkon chlazení Névleges technológiai hűtőteljesítmény
D_{B/C/D}	Potenza assorbita dichiarata Angegebene Leistungsaufnahme Potencia utilizada declarada Declared power input	Puissance absorbée déclarée Deklarerad tillförd effekt Ilmoitettu ottoteho Oplyst effektoptag	Potência de entrada declarada Opgegeven opgenomen vermogen Deklarowany pobór mocy	Deklarovaný příkon Névleges felvett elektromos teljesítmény
EER_{DC,..}	Indice di affienza energetica dichiarato Angegebene Leistungszahl Factor de eficiencia energética declarado Declared energy efficiency ratio	Coefficient d'efficacité énergétique déclaré Deklarerad köldfaktor Ilmoitettu kylmäkerroin Oplyst energieeffektivitetsfaktor	Rácio de eficiência energética declarado Opgegeven energie-efficiëntieverhouding Deklarowany wskaźnik efektywności energetycznej	Deklarovaný chladicí faktor Névleges hűtési jóságfok

7.1 Legend

Simbol	IT/DE/ES/EN	FR/SV/FI/DA	PT/NL/NO/PL	CS/HU/
	Dispositivo di controllo della capacità Leistungsregelung Control de la potencia Capacity control	Régulation de la puissance Kapacitetskontroll Tehonsäätö Ydelsesregulering	Regulação da potência Vermogensregeling Sterowanie wydajnością	Regulace výkonu Teljesítményszabályozás
C_{dc}	Coefficiente di degradazione dei chiller Minderungsfaktor von Kühlern Coeficiente de degradación de las enfriadores Degradation co-efficient chillers	Coefficient de dégradation Degraderingskoefficient för kylaggregat Jäähdytyslaitteiden alenemiskerroin Chilleres koefficient for effektivitetstab	Refrigeradores com coeficiente de degradação Verliescoëfficiënt chillers Współczynnik strat dla agregatów chłodniczych	Koeficient poklesu účinnosti chladiče A technológiai hűtő degradációs tényezője

7.2 Installation diagram

Pos.	DESCRIPTION	DENOMINAZIONE
1	Ball valves	Valvole di intercettazione
2	External pump *	Pompa esterna
2.1	Pump (chiller)	Pompa (chiller)
3	Gauges	Manometri
4	Water filter	Filtro a rete
5	Air bleed valve **	Sfiato
5.1	Air bleed valve (chiller)	Sfiato (chiller)
6	Water drain valve	Valvola di scarico acqua
7	Charge group	Gruppo di carica
7.1	Gauge	manometro
7.2	Non return valve	valvola di non ritorno
7.3	Water fill hose	tubo di alimentazione scollegabile
7.4	Pressure reducer	riduttore di pressione
8	Tank	Serbatoio
9	Expansion Tank	Vaso espansione
10	Safety valve	Valvola disicurezza
11	Flexible union	Giunto flessibile
12	Pressure switch	Pressostato

* The pump must be installed near the tank

** It must be installed at the highest point of the circuit

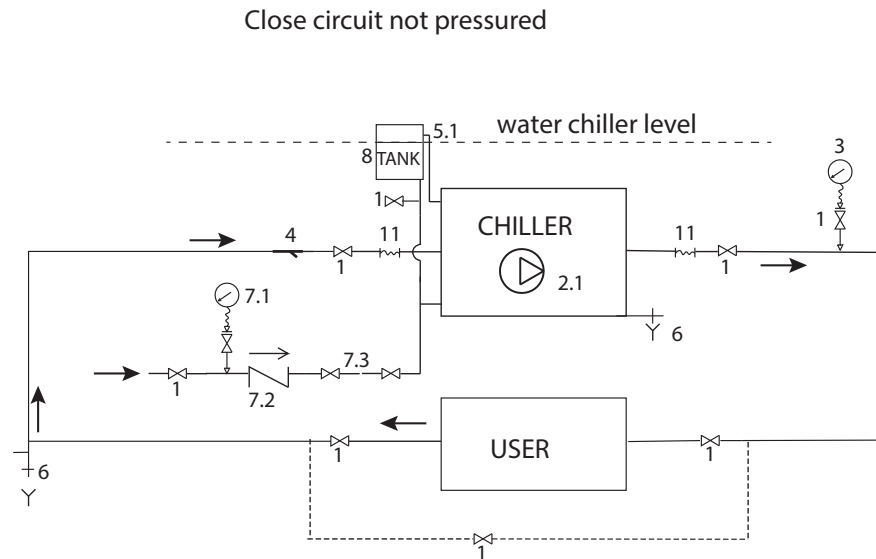
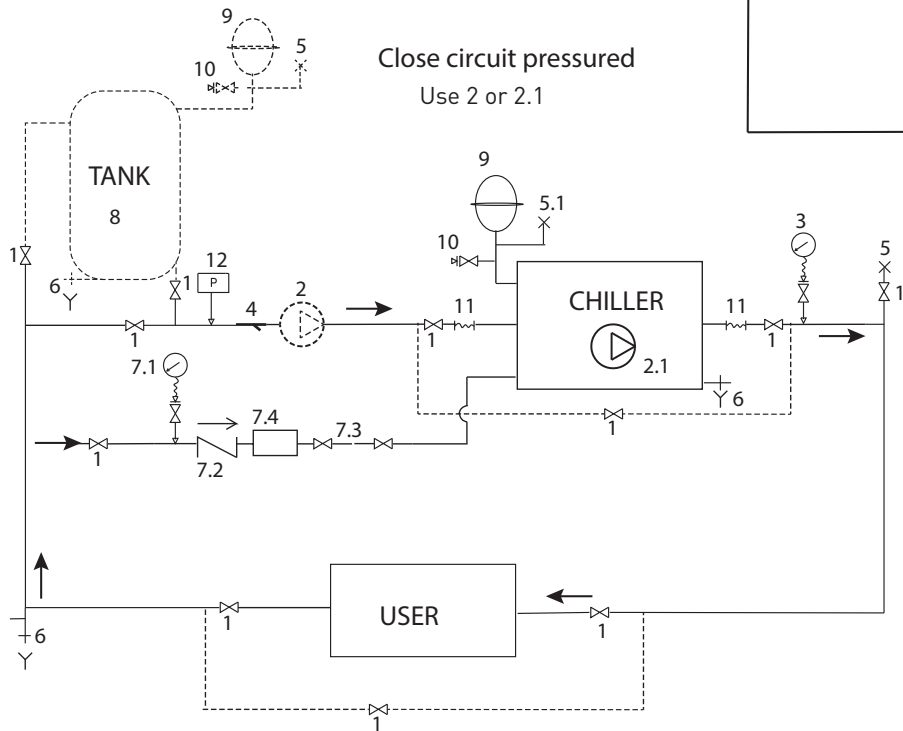
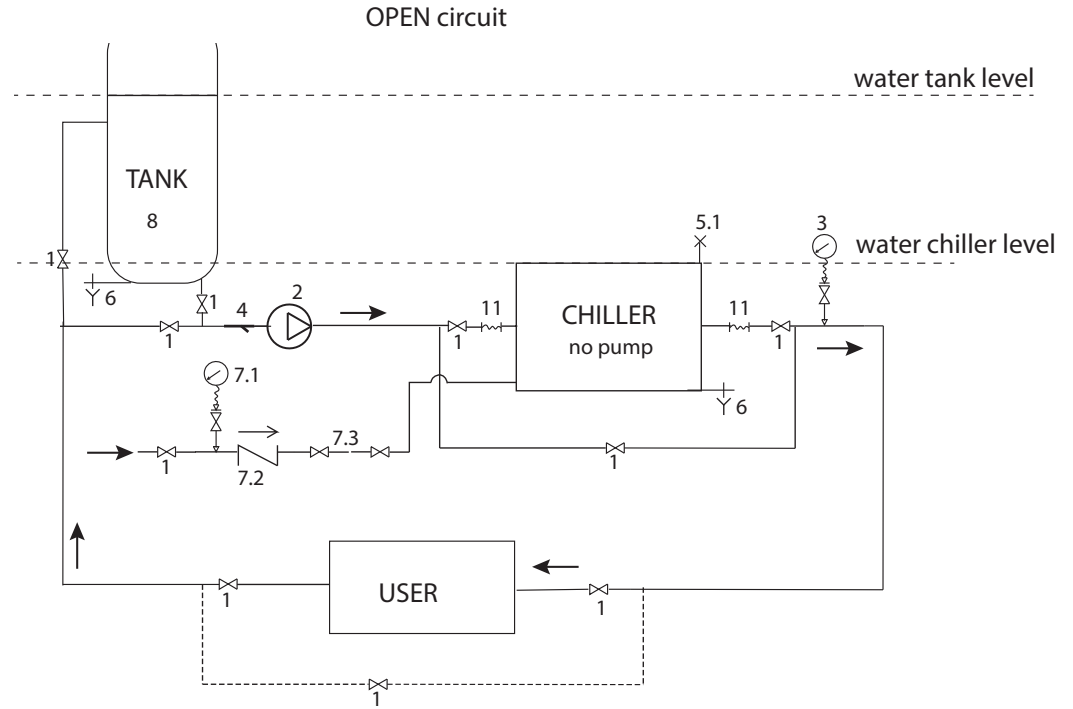

7.2 Installation diagram

OVERALL OPERATION TEMPERATURE RANGE

Operation out the mentioned limits may damage the unit. In case of any doubt contact your Parker representative.

In the following figure are illustrateci the operation ranges in standard operation, low water option and low ambient -20° C, in terms of inlet water temperature and the ambient temperature.

IMPORTANT NOTES:

Such operating range is valid considering the corresponding process water flowrate that ensures a 5 C temperature difference between the inlet and outlet water temperatures. The condensing batteries must be clean and capable of dissipating heat at maximum efficiency, and they must be installed correctly according to the installation specification avoiding the recirculation of exhaust air from the fan. The superheating was set at 5 C. Glycol utilization is mandatory to properly operate avoiding damaging the machine according to the manual specification. Any deviation from these conditions can lead to different results.

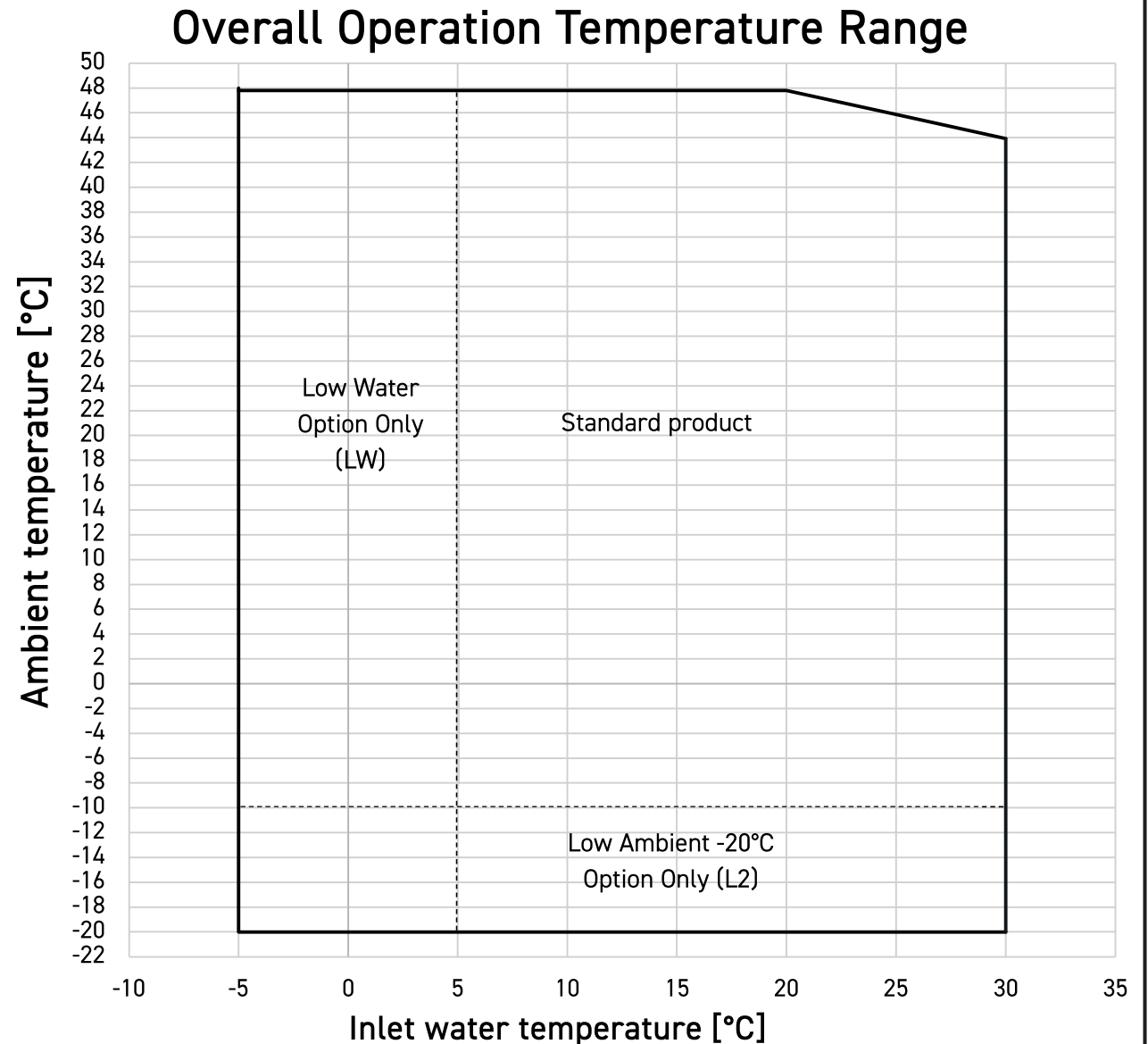

7.3 Handling, operating space



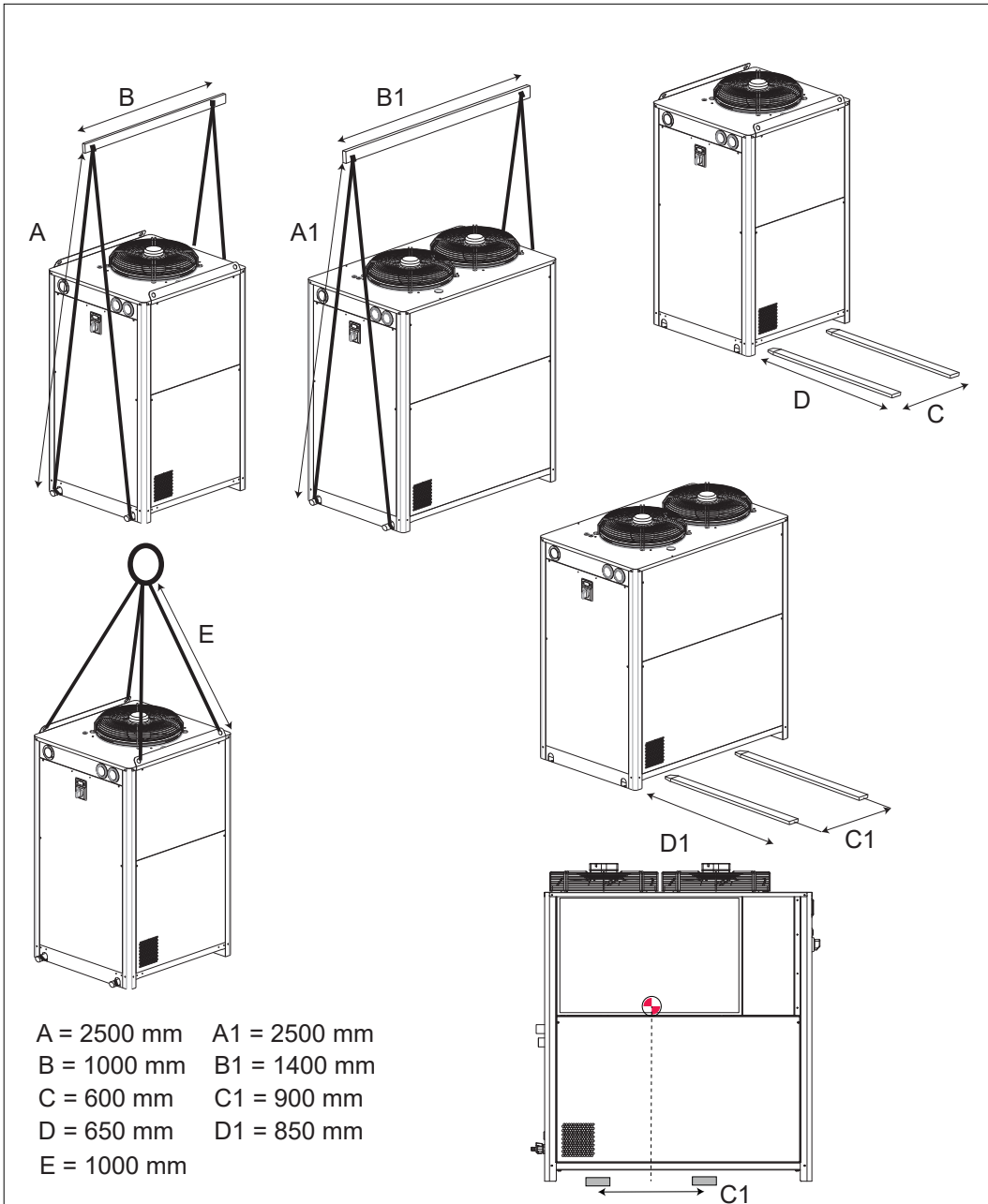



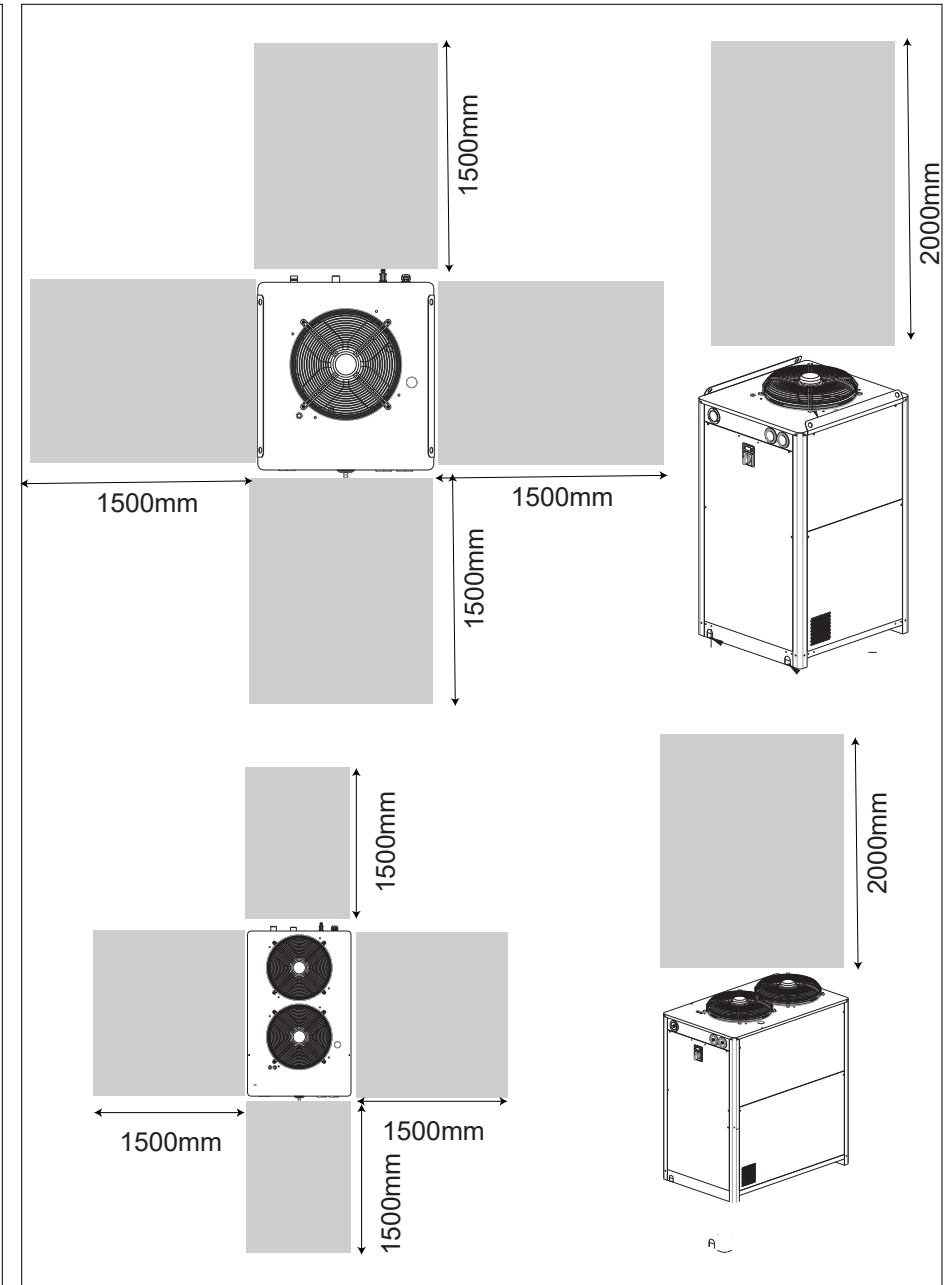

Handling



Operating space



7.4 Technical data

MODEL	Weight 		Dimensions (mm)			Amb 		Connections			dB[A] 	% gly	Water		Tank capacity (water) (l)
	Air cooled	Water cooled	Width	Depth	Height		 *		water cooled version				Operating Temperature	Operating Pressure	
ICEP008E	165		756	806	1430	0 °C 50°C	5 °C 48°C		n/a		50	40	-10°C** 30°C	0 bar 6 bar	65
ICEP011E	175		756	806	1430										65
ICEP015E	180		756	806	1430										65
ICEP022E	235	-	756	1206	1430										100
ICEP027E	250	-	756	1206	1430										100

MODEL	R513A				Power supply					F.L.A. (Full Load Ampere)[A]					IP			
	Air cooled		Water cooled			LP1 bar	HP1 bar	Fan bar	WPV bar	MC1	EV		P15	P30		P50		
	Kg	CO ₂ (t) Equivalent	Kg	CO ₂ (t) Equivalent						A	A	Air flow m ³ /h	A					
ICEP008E	1.5	0.94			400V±10% 3ph 50Hz	1.0	20.0	OFF 8 ON 10		4.5	0.46	3325	1.4	1.7	3.3	54		
ICEP011E	1.6	1.01								6.2	0.46	3325	1.4	1.7	3.3			
ICEP015E	1.65	1.04								9.7	1.0	5028	1.4	1.8	3.3			
ICEP022E	2.5	1.57	-	-				Fan 1 OFF 8 ON 10	10.0/ 11.0			11.8	1.0x2	7823	1.4		2.4	3.3
ICEP027E	4.7	2.96	-	-								Fan 2 OFF 10 ON 12			18.3		1.0x2	10865

* see the table on par. 7.2

** Under 5°C temperature, use the glycol in % in the water, see the table on par.3.3.2.

MC1 : compressor

EV : fan

P15 : pump (1,5 Barg)

P30 : pump (3,0 Barg)

P50 : pump (5,0 Barg)

Ecodesign requirements

REGULATION (EU) N. 2016/2281 FOR HIGH TEMPERATURE PROCESS CHILLERS

Model	ICEP008E (air condenser)			ICEP011E (air condenser)			ICEP015E (air condenser)			ICEP022E (air condenser)			ICEP027E (air condenser)		
	Symbol	Value	Unit	Symbol	Value	Unit	Symbol	Value	Unit	Symbol	Value	Unit	Symbol	Value	Unit
Refrigerant : R513A															
Operating temperature	t	7°C	°C	t	7°C	°C	t	7°C	°C	t	7°C	°C	t	7°C	°C
Annual electricity consumption	Q	7600	kWh/a	Q	10862	kWh/a	Q	15642	kWh/a	Q	20244	kWh/a	Q	26480	kWh/a
Seasonal energy performance ratio	SEPR	5,34	[-]	SEPR	5,4	[-]	SEPR	5,01	[-]	SEPR	5,5	[-]	SEPR	5,2	[-]
Parameters at full load and ambient temperature 35°C (Point A)															
Rated refrigeration capacity	P _A	5,49	kW	P _A	7,88	kW	P _A	10,7	kW	P _A	15,49	kW	P _A	18,53	kW
Rated power input	D _A	1,893	kW	D _A	2,67	kW	D _A	4,05	kW	D _A	5,46	kW	D _A	6,46	kW
Rated energy efficiency ratio	EER _{DC,A}	2,9	[-]	EER _{DC,A}	2,95	[-]	EER _{DC,A}	2,64	[-]	EER _{DC,A}	2,836	[-]	EER _{DC,A}	2,868	[-]
Parameters at full load and ambient temperature 25°C (Point B)															
Declared refrigeration capacity	P _B	6,11	kW	P _B	8,83	kW	P _B	12	kW	P _B	17,37	kW	P _B	20,71	kW
Declared power input	D _B	1,55	kW	D _B	2,20	kW	D _B	3,30	kW	D _B	4,43	kW	D _B	5,31	kW
Declared energy efficiency ratio	EER _{DC,B}	3,95	[-]	EER _{DC,B}	4,01	[-]	EER _{DC,B}	3,6355	[-]	EER _{DC,B}	3,924	[-]	EER _{DC,B}	3,9	[-]
Parameters at full load and ambient temperature 15°C (Point C)															
Declared refrigeration capacity	P _C	6,67	kW	P _C	9,69	kW	P _C	13,19	kW	P _C	19,08	kW	P _C	22,66	kW
Declared power input	D _C	1,27	kW	D _C	1,82	kW	D _C	2,69	kW	D _C	3,57	kW	D _C	4,41	kW
Declared energy efficiency ratio	EER _{DC,C}	5,26	[-]	EER _{DC,C}	5,31	[-]	EER _{DC,C}	4,9	[-]	EER _{DC,C}	5,35	[-]	EER _{DC,C}	5,136	[-]
Parameters at full load and ambient temperature 5°C (Point D)															
Declared refrigeration capacity	P _D	7,18	kW	P _D	10,46	kW	P _D	14,28	kW	P _D	20,62	kW	P _D	24,39	kW
Declared power input	D _D	1,06	kW	D _D	1,55	kW	D _D	2,21	kW	D _D	2,86	kW	D _D	3,75	kW
Declared energy efficiency ratio	EER _{DC,D}	6,75	[-]	EER _{DC,D}	6,75	[-]	EER _{DC,D}	6,47	[-]	EER _{DC,D}	7,2	[-]	EER _{DC,D}	6,5	[-]
Others items															
Capacity control	Fixed			Fixed			Fixed			Fixed			Fixed		
Degradation co-efficient chillers	C _{dc}	0,9	[-]	C _{dc}	0,9	[-]	C _{dc}	0,9	[-]	C _{dc}	0,9	[-]	C _{dc}	0,9	[-]
GWP of refrigerant	GWP	629	kg CO _{2eq} / (100 y)	GWP	629	kg CO _{2eq} / (100 y)	GWP	629	kg CO _{2eq} / (100 y)	GWP	629	kg CO _{2eq} / (100 y)	GWP	629	kg CO _{2eq} / (100 y)

Modbus

MODBUS (Modicon standard "so 1-based adressed")

All the variables are access as Holding register (Modbus function FC03, 40000).

Address with offset 40000 (es: 8964+40000=48964)

As standard configuration, RS-485 baudrate 38400, 8bit, Even, stop 1 address 1, you can change it by the display from size ICEP-E005 to ICEP-E120.

Address with offset 40000 (es: 8964+40000=48964)

Modbus TCP/IP is an optional kit.

Tag	Adress		Type	Acces	Description	u.m.	ICEP-E 005	ICEP-E 008 / 065	ICEP-E 080/ 120
iVER	8960	-	UINT	RO	PLC software version	X	Yes	Yes	Yes
B1	8961	-	INT	RO	Water temperature	1/10°C; 1/10°F	Yes	Yes	Yes
B2	8962	-	INT	RO	Evaporation temperature	1/10°C; 1/10°F	Yes	Yes	Yes
B3	8963	-	INT	RO	Ambient temperature	1/10°C; 1/10°F	Yes	Yes	Yes
-	8964	-	-	RO	Reserved	-	No	No	No
-	8965	-	-	RO	Reserved	-	No	No	No
-	8966	-	-	RO	Reserved	-	No	No	No
B7	8967	-	INT	RO	Out condensator temperature	1/10°C; 1/10°F	Yes	No	No
-	8968	-	-	RO	Reserved	-	No	No	No
-	8969	-	-	RO	Reserved	-	No	No	No
B10	8970	-	INT	RO	Electrical panel temperature (if fitted)	1/10°C; 1/10°F	No	Yes	Yes
P1	8971	-	INT	RO	Refrigerant high pressure side 1	1/10 Bar	No	Yes	Yes
P2	8972	-	INT	RO	Refrigerant high pressure side 2	1/10 Bar	No	No	Yes
LH20	8973	-	BOOL	RO	Low level water (if fitted - FALSE is OK)	X	Yes	Yes	Yes
OnOF	8974	-	BOOL	RO	Remote ON/OFF status request (TRUE is ON)	X	Yes	Yes	Yes
HPS1	8975	-	BOOL	RO	High pressure switch status side 1 (FALSE is OK)	X	Yes	Yes	Yes
HPS2	8976	-	BOOL	RO	High pressure switch status side 2 (FALSE is OK)	X	No	No	Yes
LPS1	8977	-	BOOL	RO	Low pressure switch status side 1 (FALSE is OK)	X	No	Yes	Yes
LPS2	8978	-	BOOL	RO	Low pressure switch status side 2 (FALSE is OK)	X	No	No	Yes
THP1	8979	-	BOOL	RO	Thermal pump 1 switch status (if fitted - FALSE is OK)	X	No	Yes	Yes
THP2	8980	-	BOOL	RO	Thermal pump 2 switch status (if fitted - FALSE is OK)	X	No	Yes	Yes
PHAS	8981	-	BOOL	RO	Sequence phase monioring (FALSE is OK)	X	No	Yes	Yes
THC1	8982	-	BOOL	RO	Thermal compressor 1 switch (if fitted - TRUE is OK)	X	No	Yes	Yes
THC2	8983	-	BOOL	RO	Thermal compressor 2 switch (if fitted - TRUE is OK)(from model 055-120)	X	No	Yes	Yes
CMP1	8984	-	BOOL	RO	Compressor 1 contactor (TRUE is ON)	X	Yes	Yes	Yes
FAN1	8985	-	BOOL	RO	Fan 1 contactor (TRUE is ON)	X	Yes	Yes	Yes
VAL1	8986	-	BOOL	RO	CPT valve 1 (if fitted - TRUE is open)	X	Yes	Yes	Yes
VAL2	8987	-	BOOL	RO	CPT valve 2 (if fitted - TRUE is open)	X	No	Yes	Yes
CMP2	8988	-	BOOL	RO	Compressor 2 contactor (TRUE is ON) (from model 055-120)	X	No	Yes	Yes
FAN2	8989	-	BOOL	RO	Fan 2 contactor (TRUE is ON)	X	No	Yes	Yes
PMP1	8990	-	BOOL	RO	Pump 1 contactor (if fitted - TRUE is ON)	X	Yes	Yes	Yes
ALRM	8991	-	BOOL	RO	Warning/Alarms relay status (TRUE is ON)	X	Yes	Yes	Yes
PSTA	8992	-	BOOL	RO	Status Chiller (TRUE if ON)	X	Yes	Yes	Yes
AOF	8993	-	BOOL	RO	Fan speed control (if fitted)	1/10%	Yes	Yes	Yes
HECA	8994	-	BOOL	RO	Cranckase heater (if fitted - TRUE is ON)	X	No	Yes	Yes
R QE	8995	-	BOOL	RO	Electrcal panel heater (if fitted - TRUE is ON)	X	No	Yes	Yes
AFHE	8996	-	BOOL	RO	Antifreeze heater (if fitted - TRUE is ON)	X	No	Yes	Yes
F QE	8997	-	BOOL	RO	Electrical panel fan (if fitted - TRUE is ON)	X	No	Yes	Yes
FAN3	8998	-	BOOL	RO	Fan 3 contactor (if fitted - TRUE is ON)	X	No	No	Yes
PMP2	8999	-	BOOL	RO	Pump 2 contactor (if fitted - TRUE is ON)	X	No	Yes	Yes
uA11	9000	-	WORD	RO	Alarm word	X	Yes	Yes	Yes
-	-	9001.0	BIT	RO	Pump 1 thermal protection	X	Yes	Yes	Yes
-	-	9001.1	BIT	RO	Pump 2 thermal protection	X	No	Yes	Yes
-	-	9001.2	BIT	RO	Low level water	X	Yes	Yes	Yes

Modbus

Tag	Adress		Type	Acces	Description	u.m.	ICEP-E 005	ICEP-E 008 / 065	ICEP-E 080/ 120
-	9001.3	BIT	RO	High temperature BT1 (if setted as alarm)	X	Yes	Yes	Yes	
-	9001.4	BIT	RO	Low temperature BT1	X	Yes	Yes	Yes	
-	9001.5	BIT	RO	High temperature BT2 (if setted as alarm)	X	Yes	Yes	Yes	
-	9001.6	BIT	RO	Low temperature BT2	X	Yes	Yes	Yes	
-	9001.7	BIT	RO	High temperature BT3 (if setted as alarm)	X	Yes	Yes	Yes	
-	9001.8	BIT	RO	Low temperature BT3	X	Yes	Yes	Yes	
-	9001.9	BIT	RO	Voltage phase and balancing monitoring	X	Yes	Yes	Yes	
-	9001.10	BIT	RO	I/O expansion	X	No	Yes	Yes	
-	9001.11	BIT	RO	Chiller configuration	X	Yes	Yes	Yes	
-	9001.12	BIT	RO	Probe BT1	X	Yes	Yes	Yes	
-	9001.13	BIT	RO	Probe BT2	X	Yes	Yes	Yes	
-	9001.14	BIT	RO	Probe BT3	X	Yes	Yes	Yes	
-	9001.15	BIT	RO	Reserved	-	No	No	No	
uAI2	9001	-	WORD	Warning word 1	X	Yes	Yes	Yes	
-	9001.0	BIT	RO	Probe BP1 fault	X	No	Yes	Yes	
-	9001.1	BIT	RO	Probe BP2 fault	X	No	No	Yes	
-	9001.2	BIT	RO	Probe BT7 fault	X	Yes	No	No	
-	9001.3	BIT	RO	High pessure switch circuit 1	X	Yes	Yes	Yes	
-	9001.4	BIT	RO	Low pessure switch circuit 1	X	No	Yes	Yes	
-	9001.5	BIT	RO	High pessure switch circuit 2	X	No	No	Yes	
-	9001.6	BIT	RO	Low pessure switch circuit 2	X	No	No	Yes	
-	9001.7	BIT	RO	Internal protection compressor 1	X	No	No	Yes	
-	9001.8	BIT	RO	Internal protection compressor 2	X	No	No	Yes	
-	9001.9	BIT	RO	Reserved	-	No	No	No	
-	9001.10	BIT	RO	Reserved	-	No	No	No	
-	9001.11	BIT	RO	Reserved	-	No	No	No	
-	9001.12	BIT	RO	Reserved	-	No	No	No	
-	9001.13	BIT	RO	Reserved	-	No	No	No	
-	9001.14	BIT	RO	Reserved	-	No	No	No	
-	9001.15	BIT	RO	Reserved	-	No	No	No	
uWn1	9002	-	WORD	Warning word 2	X	Yes	Yes	Yes	
-	9002.0	BIT	RO	High temperature BT1 (if setted - as warning)	X	Yes	Yes	Yes	
-	9002.1	BIT	RO	High temperature BT2 (if setted - as warning)	X	Yes	Yes	Yes	
-	9002.2	BIT	RO	High temperature BT3 (if setted - as warning)	X	Yes	Yes	Yes	
-	9002.3	BIT	RO	Service time elapsed	X	Yes	Yes	Yes	
-	9002.4	BIT	RO	Internal RTC error	X	Yes	Yes	Yes	
-	9002.5	BIT	RO	Reserved	-	No	No	No	
-	9002.6	BIT	RO	Reserved	-	No	No	No	
-	9002.7	BIT	RO	Reserved	-	No	No	No	
-	9002.8	BIT	RO	Reserved	-	No	No	No	
-	9002.9	BIT	RO	Reserved	-	No	No	No	
-	9002.10	BIT	RO	Reserved	-	No	No	No	
-	9002.11	BIT	RO	Reserved	-	No	No	No	
-	9002.12	BIT	RO	Reserved	-	No	No	No	
-	9002.13	BIT	RO	Reserved	-	No	No	No	
-	9002.14	BIT	RO	Reserved	-	No	No	No	
-	9002.15	BIT	RO	Reserved	-	No	No	No	
uIN	9003	-	WORD	Digital input word	X	Yes	Yes	Yes	
-	9003.0	BIT	RO	High pressure switch circuit 1	X	Yes	Yes	Yes	
-	9003.1	BIT	RO	Low level water switch	X	Yes	Yes	Yes	
-	9003.2	BIT	RO	Remote ON/OFF input	X	Yes	Yes	Yes	

Modbus

Tag	Adress		Type	Acces	Description	u.m.	ICEP-E 005	ICEP-E 008 / 065	ICEP-E 080 / 120
	-	9003.3	BIT	RO	Thermal protection pump 1 (if fitted)	X	Yes	Yes	Yes
	-	9003.4	BIT	RO	Internal protection compressor 1	X	No	No	Yes
	-	9003.5	BIT	RO	Voltage phase and balancing monitoring	X	No	Yes	Yes
	-	9003.6	BIT	RO	Low pressure switch circuit 1	X	No	Yes	Yes
	-	9003.7	BIT	RO	Thermal protection pump 2 (if fitted)	X	No	Yes	Yes
	-	9003.8	BIT	RO	Internal protection compressor 2 (if fitted)	X	No	No	Yes
	-	9003.9	BIT	RO	High pressure switch circuit 2	X	No	No	Yes
	-	9003.10	BIT	RO	Low pressure switch circuit 2	X	No	No	Yes
	-	9003.11	BIT	RO	Reserved	-	No	No	No
	-	9003.12	BIT	RO	Reserved	-	No	No	No
	-	9003.13	BIT	RO	Reserved	-	No	No	No
	-	9003.14	BIT	RO	Reserved	-	No	No	No
	-	9003.15	BIT	RO	Reserved	-	No	No	No
uIN	9004	-	WORD	RO	Digital Output word	X	Yes	Yes	Yes
	-	9004.0	BIT	RO	Plant status	X	Yes	Yes	Yes
	-	9004.1	BIT	RO	Pump 1	X	Yes	Yes	Yes
	-	9004.2	BIT	RO	General alarm	X	Yes	Yes	Yes
	-	9004.3	BIT	RO	Compressor 1	X	Yes	Yes	Yes
	-	9004.4	BIT	RO	Fan 1	X	Yes	Yes	Yes
	-	9004.5	BIT	RO	Fan 2	X	No	Yes	Yes
	-	9004.6	BIT	RO	Compressor 2 (from model 055-120)	X	No	Yes	Yes
	-	9004.7	BIT	RO	Pump 2	X	No	Yes	Yes
	-	9004.8	BIT	RO	Crankcase heater	X	No	Yes	Yes
	-	9004.9	BIT	RO	Antifreeze heater	X	No	Yes	Yes
	-	9004.10	BIT	RO	Fan 3	X	No	No	Yes
	-	9004.11	BIT	RO	Electrical panel heater	X	No	Yes	Yes
	-	9004.12	BIT	RO	CPT valve 1	X	No	Yes	Yes
	-	9004.13	BIT	RO	CPT valve 2	X	No	Yes	Yes
	-	9004.14	BIT	RO	Reserved	-	No	No	No
	-	9004.15	BIT	RO	Reserved	-	No	No	No
RES	9005	-	INT	RW	Alarm reset from Modbus	X	Yes	Yes	Yes
SUP	9006	-	BOOL	RW	ON/OFF request from Modbus	X	Yes	Yes	Yes
DEF	9007	-	BOOL	RO	Set default parameters	X	Yes	Yes	Yes
UH	9008	-	UINT	RO	Unit working hours	h	Yes	Yes	Yes
UHL	9009	-	UINT	RO	Unit working hours x1000	x1000 h	Yes	Yes	Yes
UPH	9010	-	UINT	RO	Unit Partial working hours	h	Yes	Yes	Yes
UPHL	9011	-	UINT	RO	Unit Partial working hours x1000	x1000 h	Yes	Yes	Yes
CIH	9012	-	UINT	RO	Compressor 1 working hours	h	Yes	Yes	Yes
CIHL	9013	-	UINT	RO	Compressor 1 working hours x1000	x1000 h	Yes	Yes	Yes
C2H	9014	-	UINT	RO	Compressor 2 working hours (from model 055-120)	h	No	Yes	Yes
C2HL	9015	-	UINT	RO	Compressor 2 working hours x1000 (from model 055-120)	x1000 h	No	Yes	Yes
ER01	9016	-	USINT	RO	Alarm probe BT1	X	Yes	Yes	Yes
ER02	9017	-	USINT	RO	Alarm probe BT2	X	Yes	Yes	Yes
ER03	9018	-	USINT	RO	Alarm probe BT3	X	Yes	Yes	Yes
ER04	9019	-	USINT	RO	Alarm probe BT7	X	Yes	No	No
ER05	9020	-	USINT	RO	Alarm probe BT10	X	Yes	Yes	Yes
ER06	9021	-	USINT	RO	Alarm probe BP1	X	Yes	Yes	Yes
ER07	9022	-	USINT	RO	Alarm probe BP2	X	No	No	Yes
ER08	9023	-	USINT	RO	High pressure alarm circuit 1	X	Yes	Yes	Yes
ER09	9024	-	USINT	RO	Low pressure alarm circuit 1	X	Yes	Yes	Yes
ER10	9025	-	USINT	RO	High pressure alarm circuit 2	X	No	No	Yes

Modbus

Tag	Adress		Type	Acces	Description	u.m.	ICEP-E 005	ICEP-E 008 / 065	ICEP-E 080 / 120
ER11	9026	-	USINT	RO	Low pressure alarm circuit 2	X	No	No	Yes
ER12	9027	-	USINT	RO	High temperature BT1 alarm	X	Yes	Yes	Yes
ER13	9028	-	USINT	RO	Low temperature BT1 alarm	X	Yes	Yes	Yes
ER14	9029	-	USINT	RO	High temperature BT2 alarm	X	Yes	Yes	Yes
ER15	9030	-	USINT	RO	Low temperature BT2 alarm	X	Yes	Yes	Yes
ER16	9031	-	USINT	RO	High temperature BT3 alarm	X	Yes	Yes	Yes
ER17	9032	-	USINT	RO	Low temperature BT3 alarm	X	Yes	Yes	Yes
ER18	9033	-	USINT	RO	Internal protection compressor 1 alarm	X	No	Yes	Yes
ER19	9034	-	USINT	RO	Internal protection compressor 2 alarm	X	No	Yes	Yes
ER20	9035	-	USINT	RO	Motor pump 1 protection alarm	X	No	Yes	Yes
ER21	9036	-	USINT	RO	Motor pump 2 protection alarm	X	No	Yes	Yes
ER22	9037	-	USINT	RO	Low level water alarm	X	Yes	Yes	Yes
ER23	9038	-	USINT	RO	Phase monitoring alarm	X	No	Yes	Yes
ER24	9039	-	USINT	RO	I/O expansion alarm	X	No	Yes	Yes
ER25	9040	-	USINT	RO	Reserved	-	No	No	No
ER26	9041	-	USINT	RO	Reserved	-	No	No	No
ER27	9042	-	USINT	RO	Service time alarm	X	Yes	Yes	Yes
ER28	9043	-	USINT	RO	RTC alarm	X	Yes	Yes	Yes
ER29	9044	-	USINT	RO	Configuration alarm	X	Yes	Yes	Yes
Set	9045	-	INT	RW	Water set point	1/10°C; 1/10°F	Yes	Yes	Yes
Set Min	9046	-	INT	RO	Water set point min. value settable	1/10°C; 1/10°F	Yes	Yes	Yes
Set Max	9047	-	INT	RO	Water set point max. value settable	1/10°C; 1/10°F	Yes	Yes	Yes
dIF1	9048	-	INT	RW	Differential for compressor thermostating	1/10°C; 1/10°F	Yes	Yes	Yes
dIF1 Min	9049	-	INT	RO	Differential for compr. thermostating min. value settable	1/10°C; 1/10°F	Yes	Yes	Yes
dIF1 Max	9050	-	INT	RO	Differential for compr. thermostating max. value settable	1/10°C; 1/10°F	Yes	Yes	Yes
HA1	9051	-	INT	RO	BT1 high temperature alarm	1/10°C; 1/10°F	Yes	Yes	Yes
HA1 Min	9052	-	INT	RO	BT1 high temperature alarm min. value settable	1/10°C; 1/10°F	Yes	Yes	Yes
HA1 Max	9053	-	INT	RO	BT1 high temperature alarm max. value settable	1/10°C; 1/10°F	Yes	Yes	Yes
SFQE	9054	-	INT	RO	Set On fan inside the QE	1/10°C; 1/10°F	No	Yes	Yes
SFQE Min	9055	-	INT	RO	Set On fan inside the QE min. value settable	1/10°C; 1/10°F	No	Yes	Yes
SFQE Max	9056	-	INT	RO	Set On fan inside the QE max. value settable	1/10°C; 1/10°F	No	Yes	Yes
SRQE	9057	-	INT	RO	Set On Heater inside the QE	1/10°C; 1/10°F	No	Yes	Yes
SRQE Min	9058	-	INT	RO	Set On Heater inside the QE min. value settable	1/10°C; 1/10°F	No	Yes	Yes
SRQE Max	9059	-	INT	RO	Set On Heater inside the QE max. value settable	1/10°C; 1/10°F	No	Yes	Yes
D QE	9060	-	INT	RO	Differential for ON Heater/Fan thermostating	1/10°C; 1/10°F	No	Yes	Yes
D QE Min	9061	-	INT	RO	Differential for ON Heater/Fan thermostating Min.	1/10°C; 1/10°F	No	Yes	Yes
D QE Max	9062	-	INT	RO	Differential for ON Heater/Fan thermostating Max.	1/10°C; 1/10°F	No	Yes	Yes
dIF2	9063	-	INT	RW	Differential for CPT thermostating	1/10°C; 1/10°F	Yes	Yes	Yes
dIF2 Min	9064	-	INT	RO	Differential for CPT thermostating min. value settable	1/10°C; 1/10°F	Yes	Yes	Yes
dIF2 Max	9065	-	INT	RO	Differential for CPT thermostating max. value settable	1/10°C; 1/10°F	Yes	Yes	Yes
LIS	9066	-	INT	RO	Water Set point lower limit	1/10°C; 1/10°F	Yes	Yes	Yes
LIS Min	9067	-	INT	RO	Water Set point lower limit min. value settable	1/10°C; 1/10°F	Yes	Yes	Yes
LIS Max	9068	-	INT	RO	Water Set point lower limit max. value settable	1/10°C; 1/10°F	Yes	Yes	Yes
LA1	9069	-	INT	RW	BT1 low temperature alarm	1/10°C; 1/10°F	Yes	Yes	Yes
LA1 Min	9070	-	INT	RO	BT1 low temperature alarm min. value settable	1/10°C; 1/10°F	Yes	Yes	Yes
LA1 Max	9071	-	INT	RO	BT1 low temperature alarm max. value settable	1/10°C; 1/10°F	Yes	Yes	Yes
Db1	9072	-	INT	RW	BT1 low temperature alarm retrigger	1/10°C; 1/10°F	Yes	Yes	Yes
Db1 Min	9073	-	INT	RO	BT1 low temperature alarm retrigger min. value settable	1/10°C; 1/10°F	Yes	Yes	Yes
Db1 Max	9074	-	INT	RO	BT1 low temperature alarm retrigger max. value settable	1/10°C; 1/10°F	Yes	Yes	Yes
HA2	9075	-	INT	RW	BT2 high temperature alarm	1/10°C; 1/10°F	Yes	Yes	Yes
HA2 Min	9076	-	INT	RO	BT2 high temperature alarm min. value settable	1/10°C; 1/10°F	Yes	Yes	Yes

Modbus

Tag	Adress		Type	Acces	Description	u.m.	ICEP-E 005	ICEP-E 008 / 065	ICEP-E 080 / 120
HA2 Max	9077	-	INT	RO	BT2 high temperature alarm max. value settable	1/10°C; 1/10°F	Yes	Yes	Yes
LA2	9078	-	INT	RW	BT2 low temperature alarm	1/10°C; 1/10°F	Yes	Yes	Yes
LA2 Min	9079	-	INT	RO	BT2 low temperature alarm min. value settable	1/10°C; 1/10°F	Yes	Yes	Yes
LA2 Max	9080	-	INT	RO	BT2 low temperature alarm max. value settable	1/10°C; 1/10°F	Yes	Yes	Yes
HA3	9081	-	INT	RW	BT3 high temperature alarm	1/10°C; 1/10°F	Yes	Yes	Yes
HA3 Min	9082	-	INT	RO	BT3 high temperature alarm min. value settable	1/10°C; 1/10°F	Yes	Yes	Yes
HA3 Max	9083	-	INT	RO	BT3 high temperature alarm max. value settable	1/10°C; 1/10°F	Yes	Yes	Yes
LA3	9084	-	INT	RW	BT3 low temperature alarm	1/10°C; 1/10°F	Yes	Yes	Yes
LA3 Min	9085	-	INT	RO	BT3 low temperature alarm min. value settable	1/10°C; 1/10°F	Yes	Yes	Yes
LA3 Max	9086	-	INT	RO	BT3 low temperature alarm max. value settable	1/10°C; 1/10°F	Yes	Yes	Yes
SEA	9087	-	INT	RW	BT1 set point antifreeze	1/10°C; 1/10°F	Yes	Yes	Yes
SEA Min	9088	-	INT	RO	BT1 set point antifreeze min. value settable	1/10°C; 1/10°F	Yes	Yes	Yes
SEA Max	9089	-	INT	RO	BT1 set point antifreeze max. value settable	1/10°C; 1/10°F	Yes	Yes	Yes
DIA	9090	-	INT	RW	BT1 thermostatic differential	1/10°C; 1/10°F	Yes	Yes	Yes
DIA Min	9091	-	INT	RO	BT1 thermostatic differential min. value settable	1/10°C; 1/10°F	Yes	Yes	Yes
DIA Max	9092	-	INT	RO	BT1 thermostatic differential max. value settable	1/10°C; 1/10°F	Yes	Yes	Yes
ARA	9093	-	INT	RW	BT3 set point activation	1/10°C; 1/10°F	Yes	Yes	Yes
ARA Min	9094	-	INT	RO	BT3 set point activation min. value settable	1/10°C; 1/10°F	Yes	Yes	Yes
ARA Max	9095	-	INT	RO	BT3 set point activation max. value settable	1/10°C; 1/10°F	Yes	Yes	Yes
DtHA	9096	-	INT	RW	Differential for dipendet water exit value	1/10°C; 1/10°F	Yes	Yes	Yes
DtHA Min	9097	-	INT	RO	Differential for dipendet water exit value min. v.s.	1/10°C; 1/10°F	Yes	Yes	Yes
DtHA Max	9098	-	INT	RO	Differential for dipendet water exit value max. v.s.	1/10°C; 1/10°F	Yes	Yes	Yes
DMIN	9099	-	INT	RW	Min value to run compressor in ERD	1/10°C; 1/10°F	Yes	Yes	Yes
DMIN Min	9100	-	INT	RO	Min value to run compressor in ERD value min. v.s.	1/10°C; 1/10°F	Yes	Yes	Yes
DMIN Max	9101	-	INT	RO	Min value to run compressor in ERD value max. v.s.	1/10°C; 1/10°F	Yes	Yes	Yes
DMAX	9102	-	INT	RW	Max value to run compressor in ERD	1/10°C; 1/10°F	Yes	Yes	Yes
DMAX Min	9103	-	INT	RO	Max value to run compressor in ERD value min. v.s.	1/10°C; 1/10°F	Yes	Yes	Yes
DMAX Max	9104	-	INT	RO	Max value to run compressor in ERD value max. v.s.	X	Yes	Yes	Yes
HysP	9105	-	INT	RW	Historical Record: 0= Most recent / 39 = Oldest	X	Yes	Yes	Yes
HysC	9106	-	INT	RO	Historical Alarm code	X	Yes	Yes	Yes
Hysd	9107	-	INT	RO	Historical Alarm date	X	Yes	Yes	Yes
Hyst	9108	-	INT	RO	Historical Alarm time	X	Yes	Yes	Yes
HUSS	9109	-	INT	RO	Historical Alarm time	X	Yes	Yes	Yes
HUSSt	9110	-	INT	RO	Historical Alarm time	X	Yes	Yes	Yes
HUSE	9111	-	INT	RO	Historical Alarm time	X	Yes	Yes	Yes
Hys1	9112	-	INT	RO	Historical Alarm B1 value	X	Yes	Yes	Yes
Hys2	9113	-	INT	RO	Historical Alarm B2 value	X	Yes	Yes	Yes
Hys3	9114	-	INT	RO	Historical Alarm SET value	X	Yes	Yes	Yes
HysF	9115	-	UINT	RO	Historical Number of records	X	Yes	Yes	Yes
A1	16384	-	BOOL	RW	Unit of measure (False = °C; True = °F)	X	Yes	Yes	Yes
A7	16385	-	USINT	RW	Enable remote ON/OFF hard wiring	X	Yes	Yes	Yes
CFJ1	16386	-	USINT	RW	ALarm relay managment	X	Yes	Yes	Yes
SUP	16387	-	BOOL	RW	Enable remote ON/OFF modbus	X	Yes	Yes	Yes
-	16388	-	-	RO	Reserved	-	No	No	No
-	16389	-	-	RO	Reserved	-	No	No	No
AST	16390	-	-	RO	Autostart enable	X	Yes	Yes	Yes

7.5 Dimensional drawings ICEP008-015E (air cond. A)

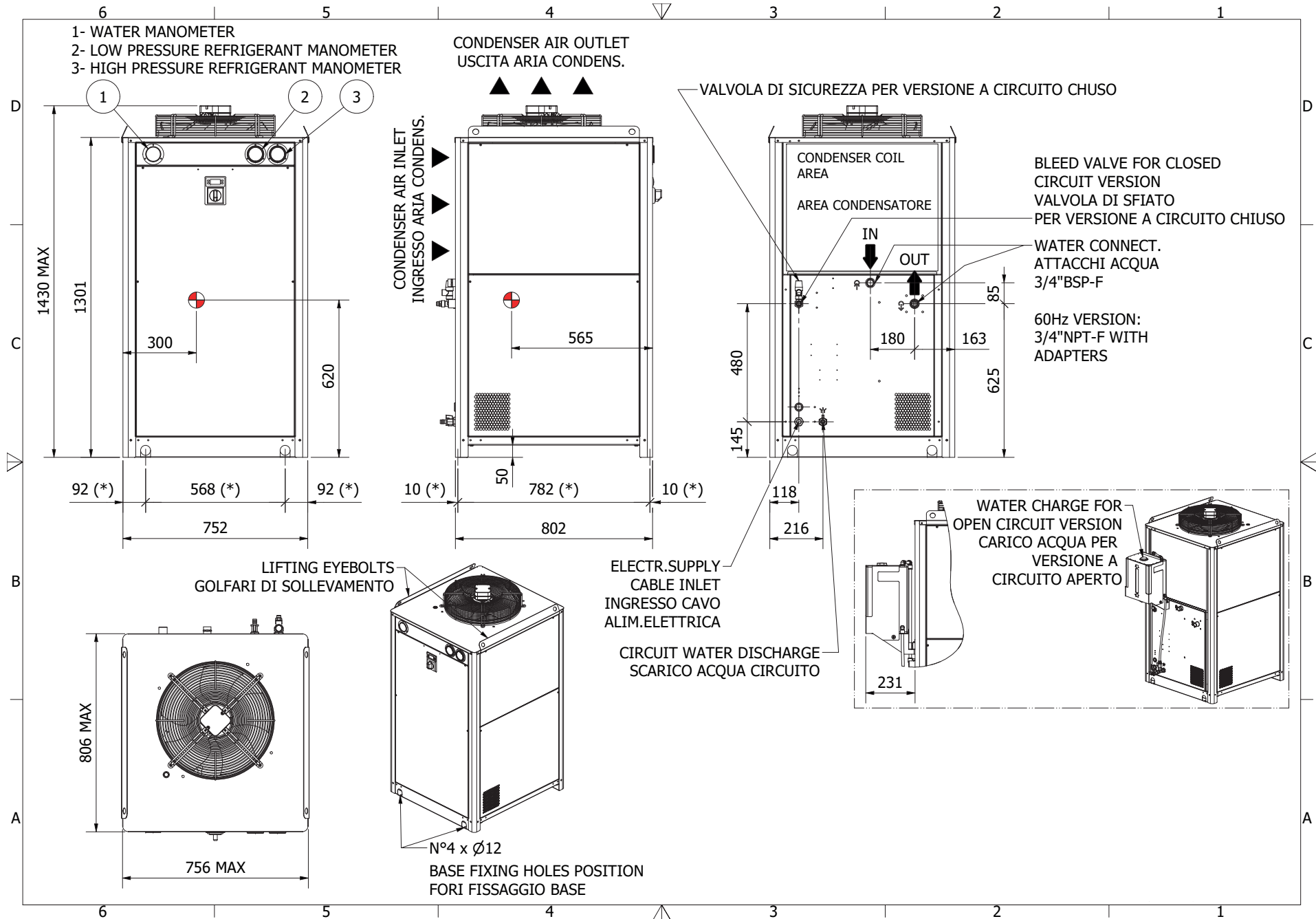

ICEP008E-ICEP027E

Dimensional drawings ICEP022E (air cond. A)

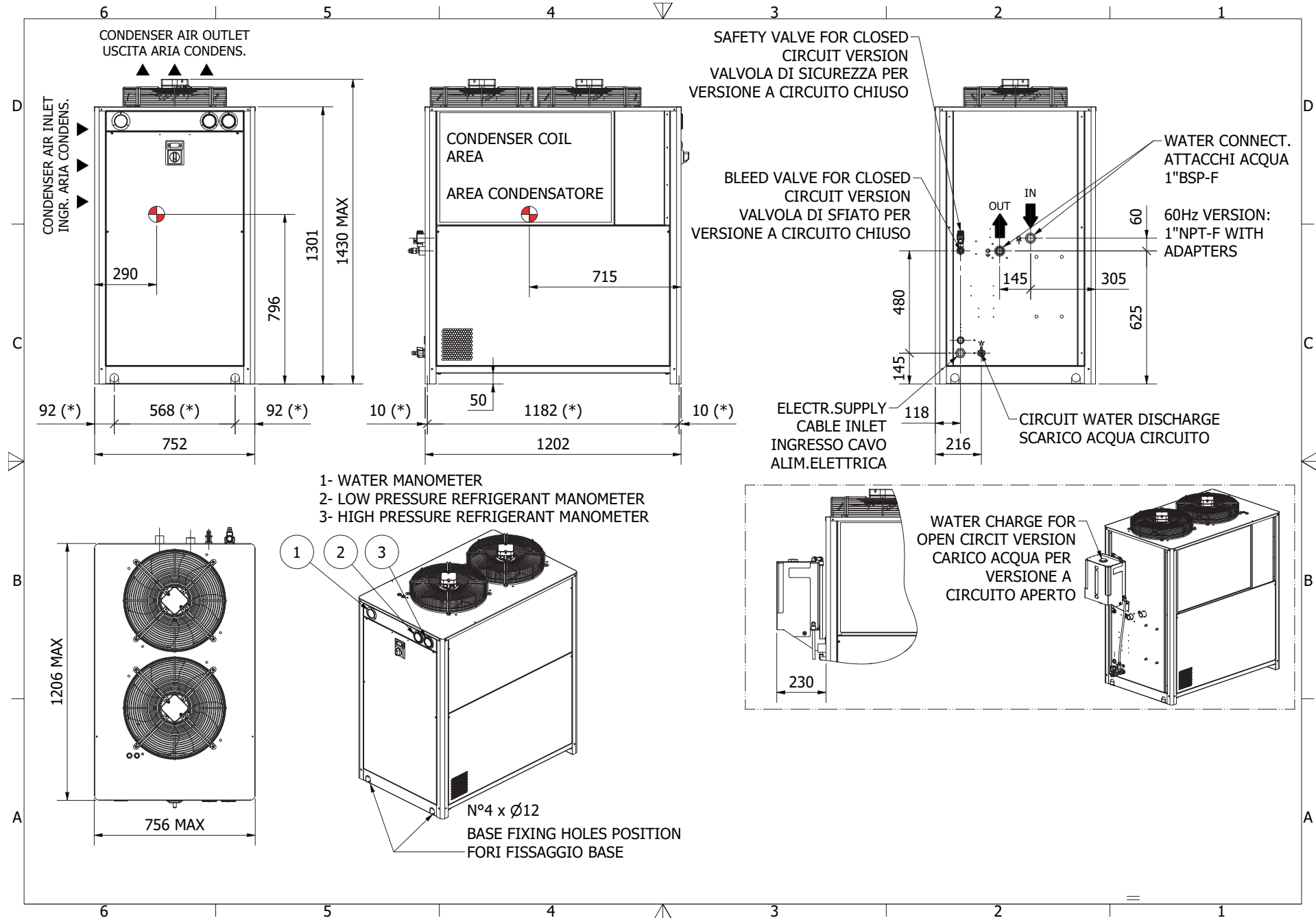

Dimensional drawings ICEP027E (air cond. A)

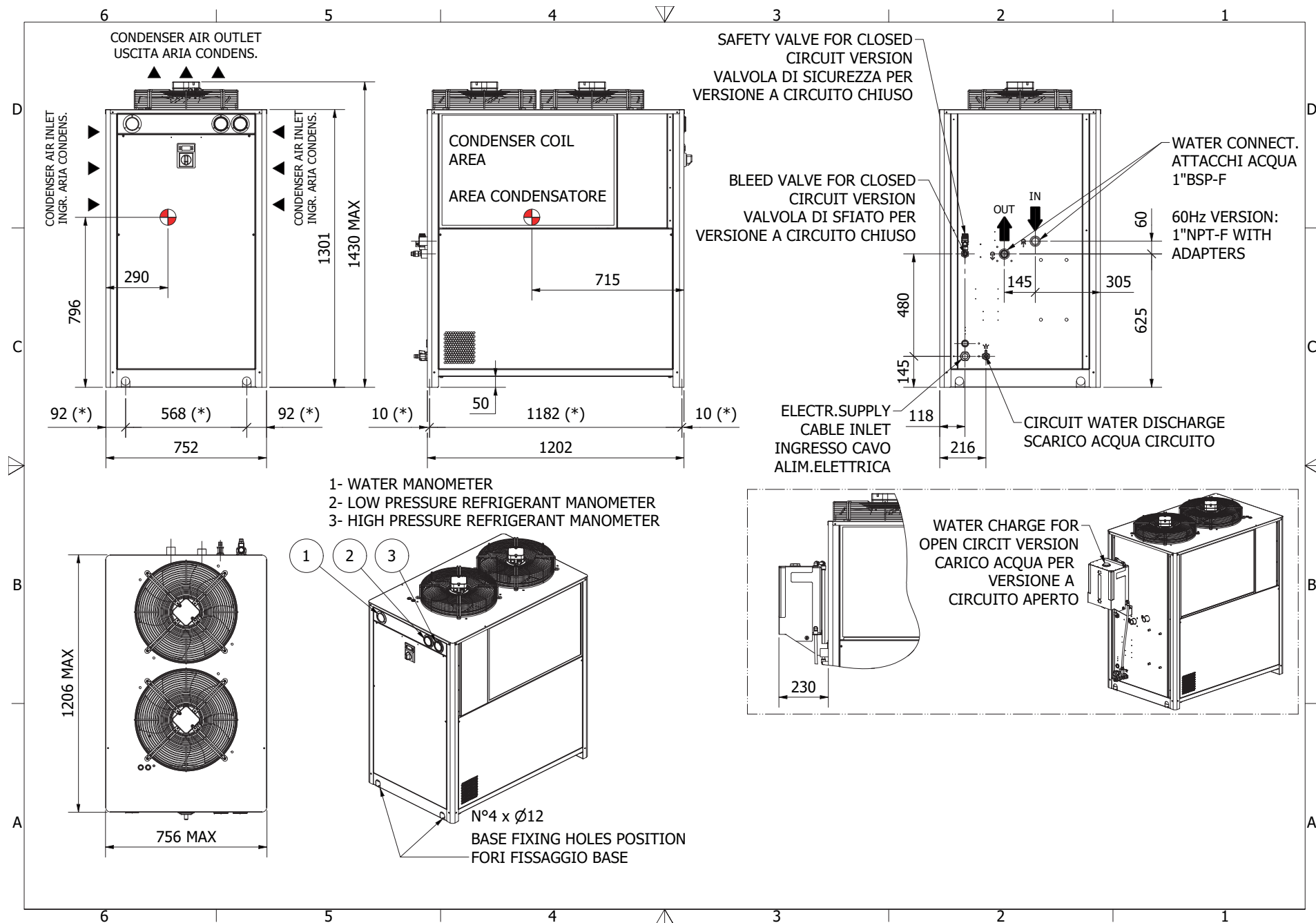

Dimensional drawings ICEP022-27E (water cond. W)

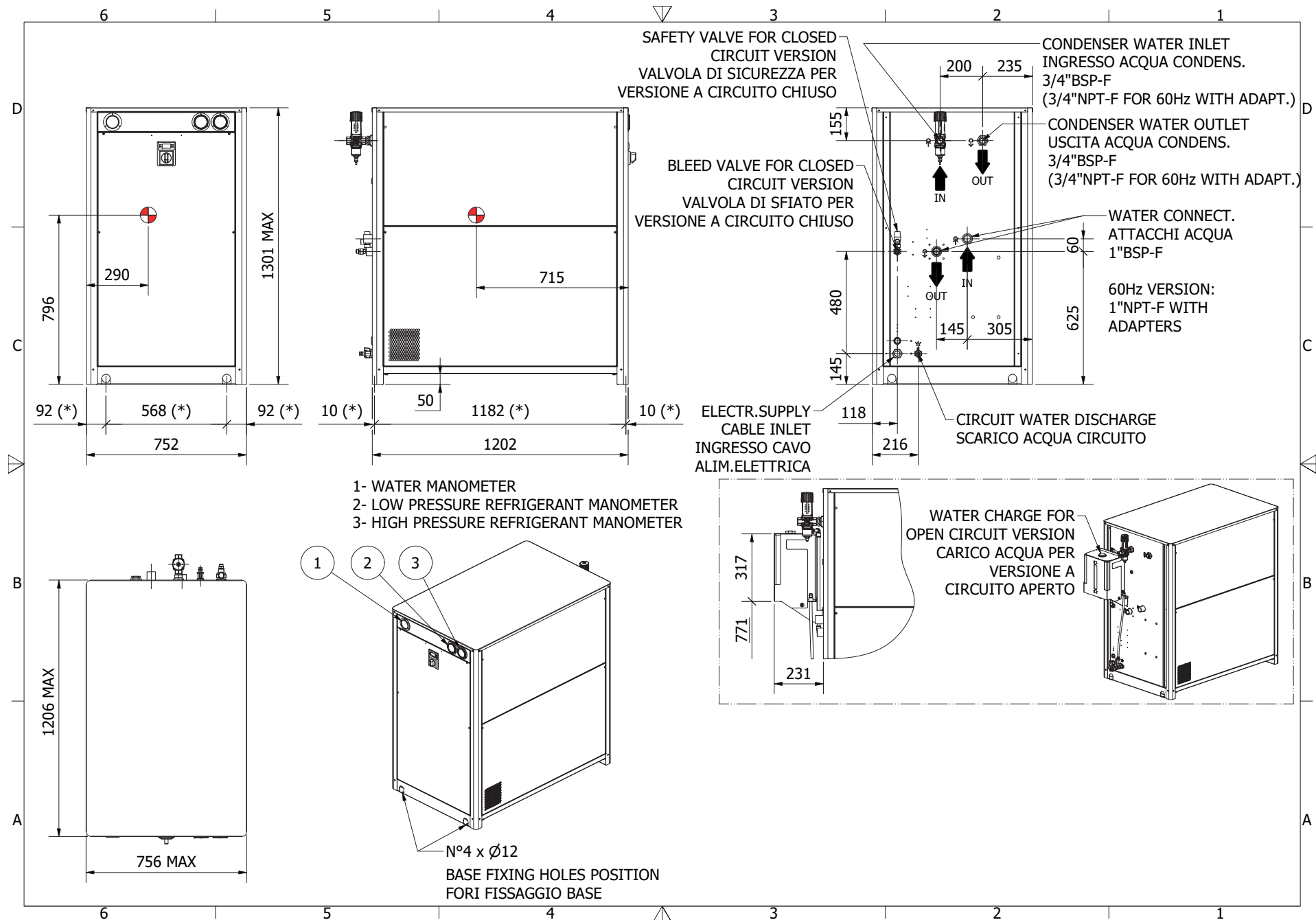

Dimensional drawings - External tank

MANUAL

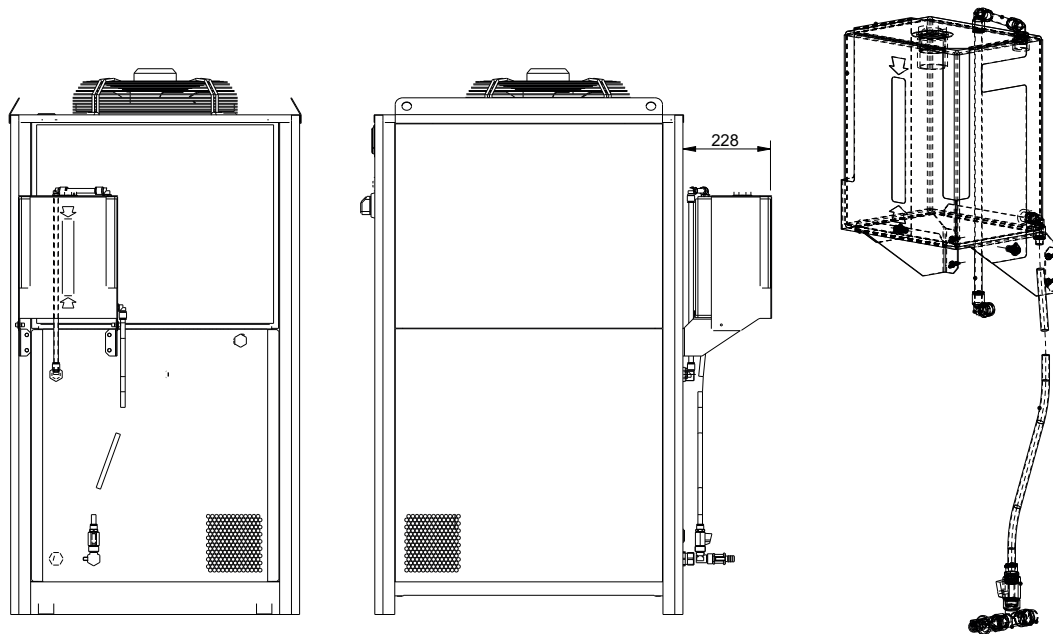

AUTOMATIC

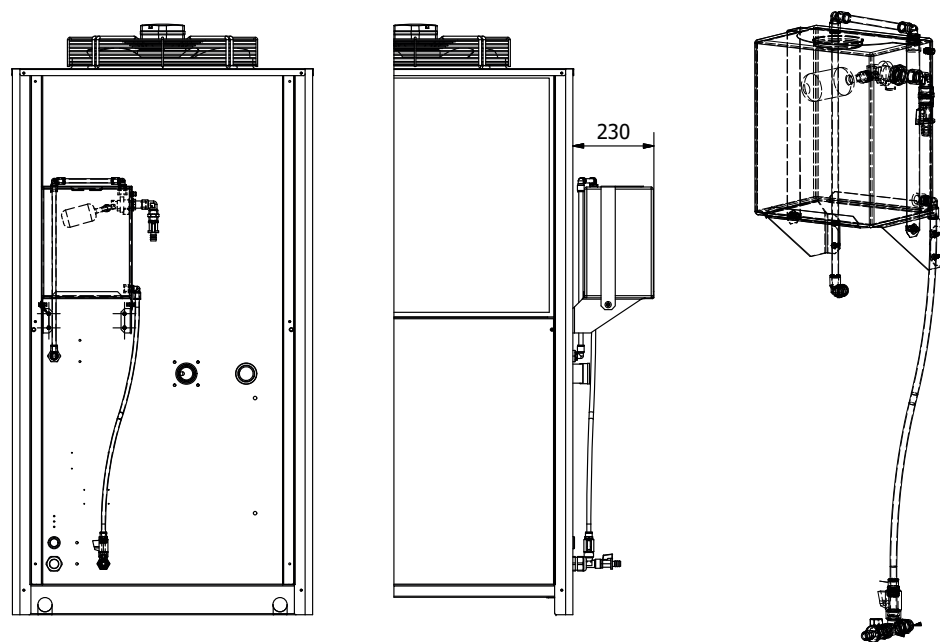

ICEP008E-ICEP027E

7.6 Spare parts

COMPONENT (Air = A; Water = W)		(7.7-7.8- 7.9)	ICEP008E	ICEP011E	ICEP015E	ICEP022E	ICEP027E	
Maintenance kit	A/W	-	398H473831			398H473832		
Electrical kit	A/W	-	398H473803			398H473804		
Compressor kit	A/W	① ④ KM1	398H473760	398H473762	398H473764	398H473616	398H473768	
Fan kit	A	③ KM5	398H473568			398H473569		
Expansion valve kit	A/W	④ ⑤	398H473808	398H473809	398H473810	398H473811	398H473812	
Plate type heat exchanger kit	A/W	⑥	398H473628	398H473629	398H473630	398H473631	398H473632	
Pump kit P30 (3 barg)	A/W	⑦ KM7	398H473572		398H473235	398H473236		
Pump kit P15 (1.5 barg)			398H473608					398H473610
Pump kit P50 (5 barg)			398H473609					398H473547
Tank kit	A/W	⑧	398H473580			398H473581		
Refrigerant condenser	A	②	ET-398H114849			ET-398H114852	ET-398H114839	
Refrigerant filter	A/W	④	398H206226			ET-398H206257		
Water manometer	A/W	⑪	398H354031					
Water outlet temperature sensor	A/W	⑬	398H275894					
Evaporator temperature sensor (anti-freeze)	A/W	⑭	398H275894					
Water level sensor	A/W	⑮	398H275924					
Electronic control	A/W	A1⑯	398H473649					
Differential water pressure switch	A/W	⑰	398H354136					
High pressure switch	A/W	⑱	ET-398H474520					
Low pressure switch	A/W	⑲	ET-398H474521					
Low pressure side manometer	A/W	⑳	398H354042					
High pressure side manometer	A/W	㉑	398H354042					
Coil (Hot gas valve)	A/W	㉒㉓	398H254009					

7.6 Spare parts

COMPONENT (Air = A; Water = W)		(7.7-7.8- 7.9)	ICEP008E	ICEP011E	ICEP015E	ICEP022E	ICEP027E
Sight glass	A/W	②4	ET-398H348008			ET-398H348007	
High pressure trasmitter	A/W	②5	398H275311				
Ambient temperature sensor	A/W	②6	398H275233				
No return valve kit	A/W	②8	-			398H785321	
Pressostativ valve	W	②9					
Main switch	A/W	QS1	398H256418			398H256422	
Auxliary transformer	A/W	TC1	on request			on request	
Phase monitor	A/W	FV1	398H256366				

7.7 Exploded drawing ICEP008-011-015E

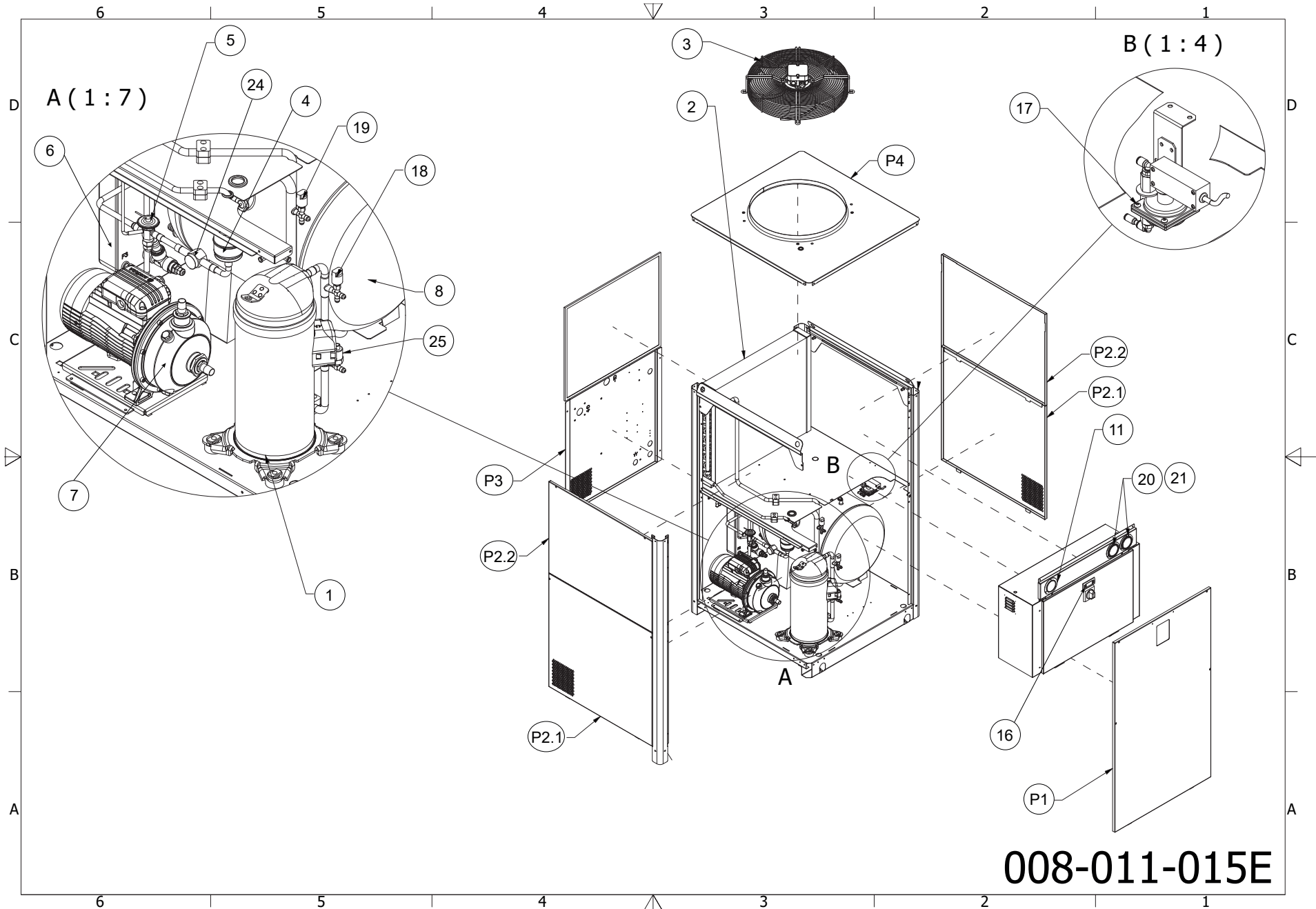

Exploded drawing ICEP022E

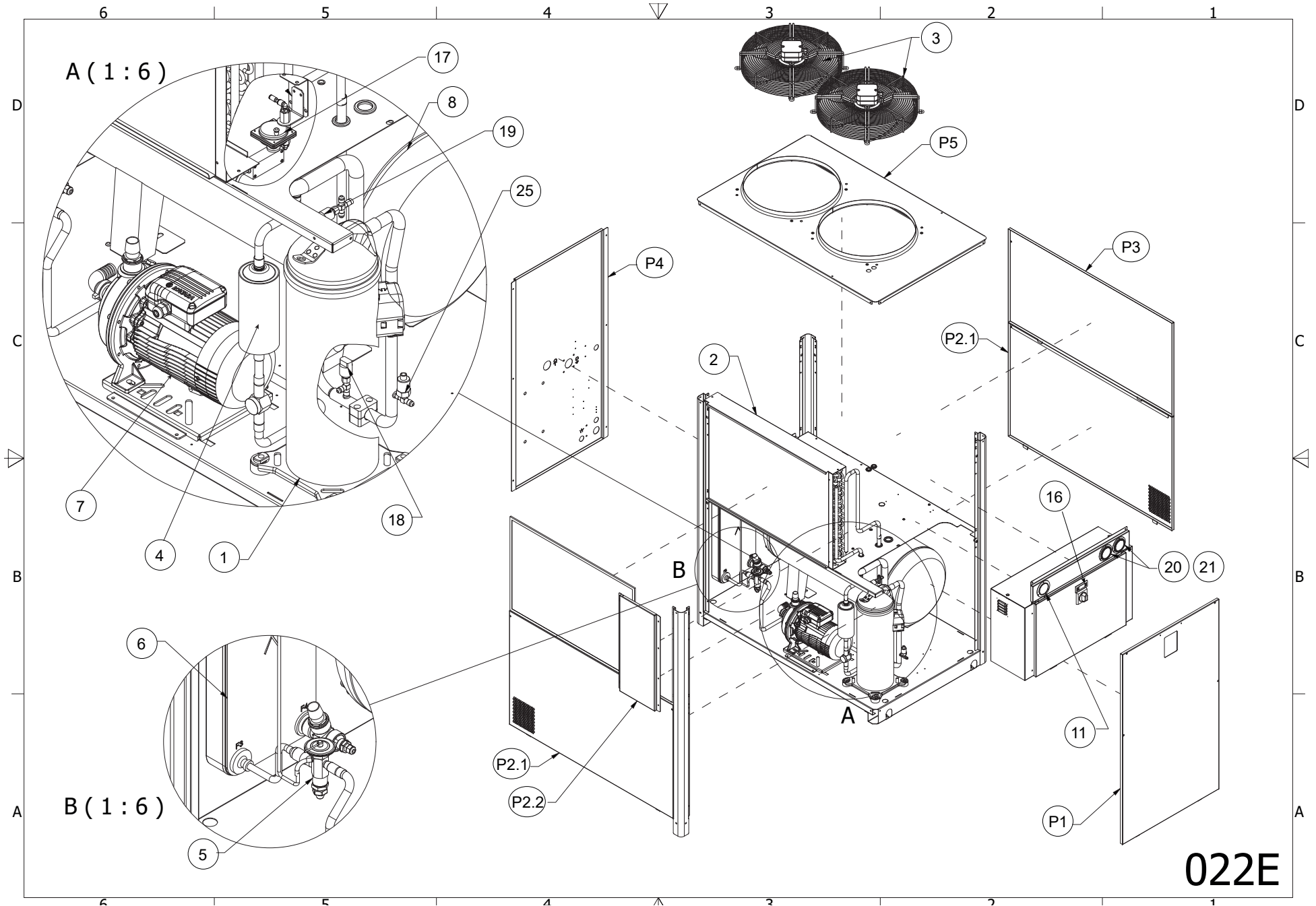

022E

Exploded drawing ICEP027E

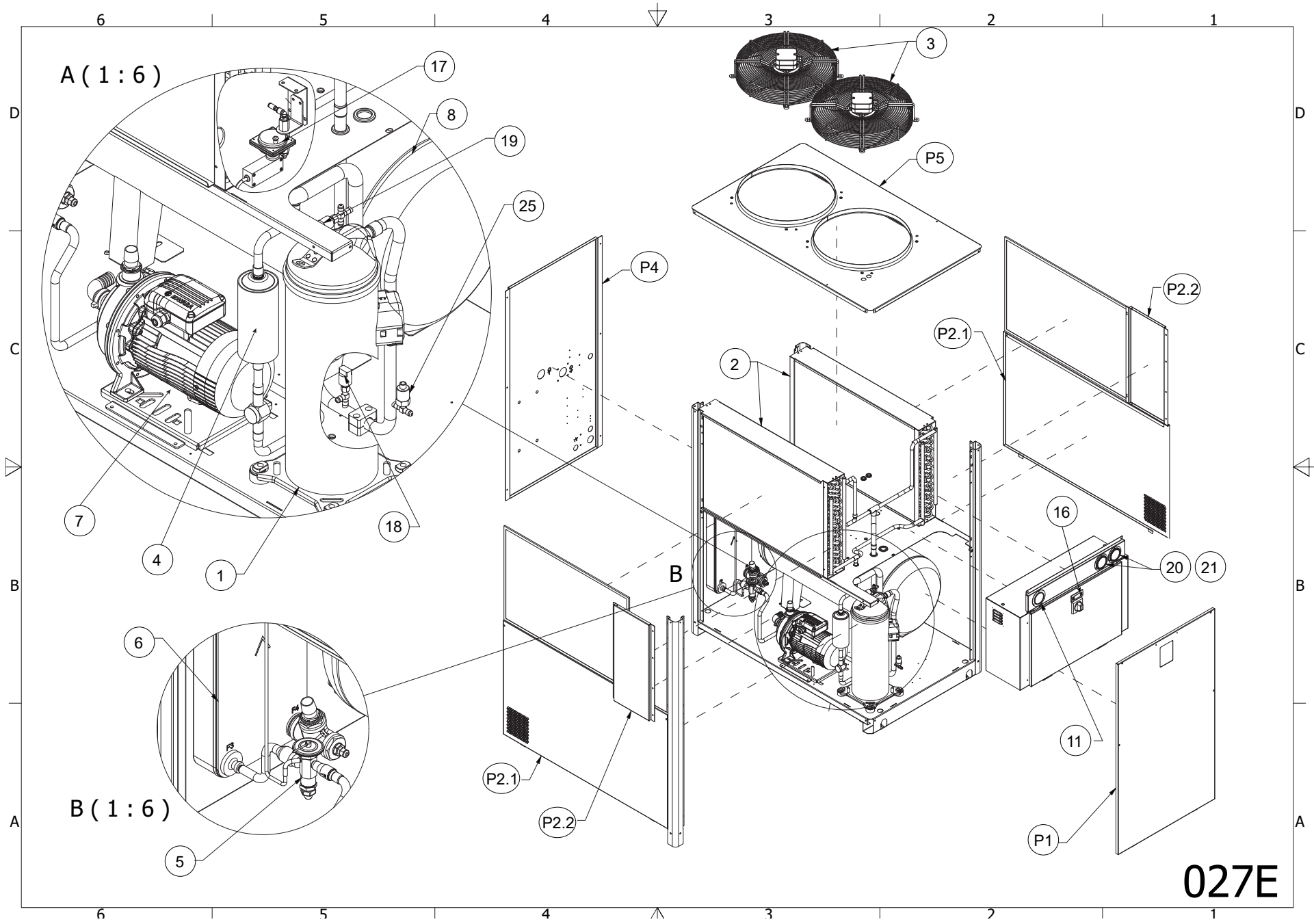

027E

ICEP008E-ICEP027E

7.8 Circuit Diagram ICEP008-015E (air cond. A)

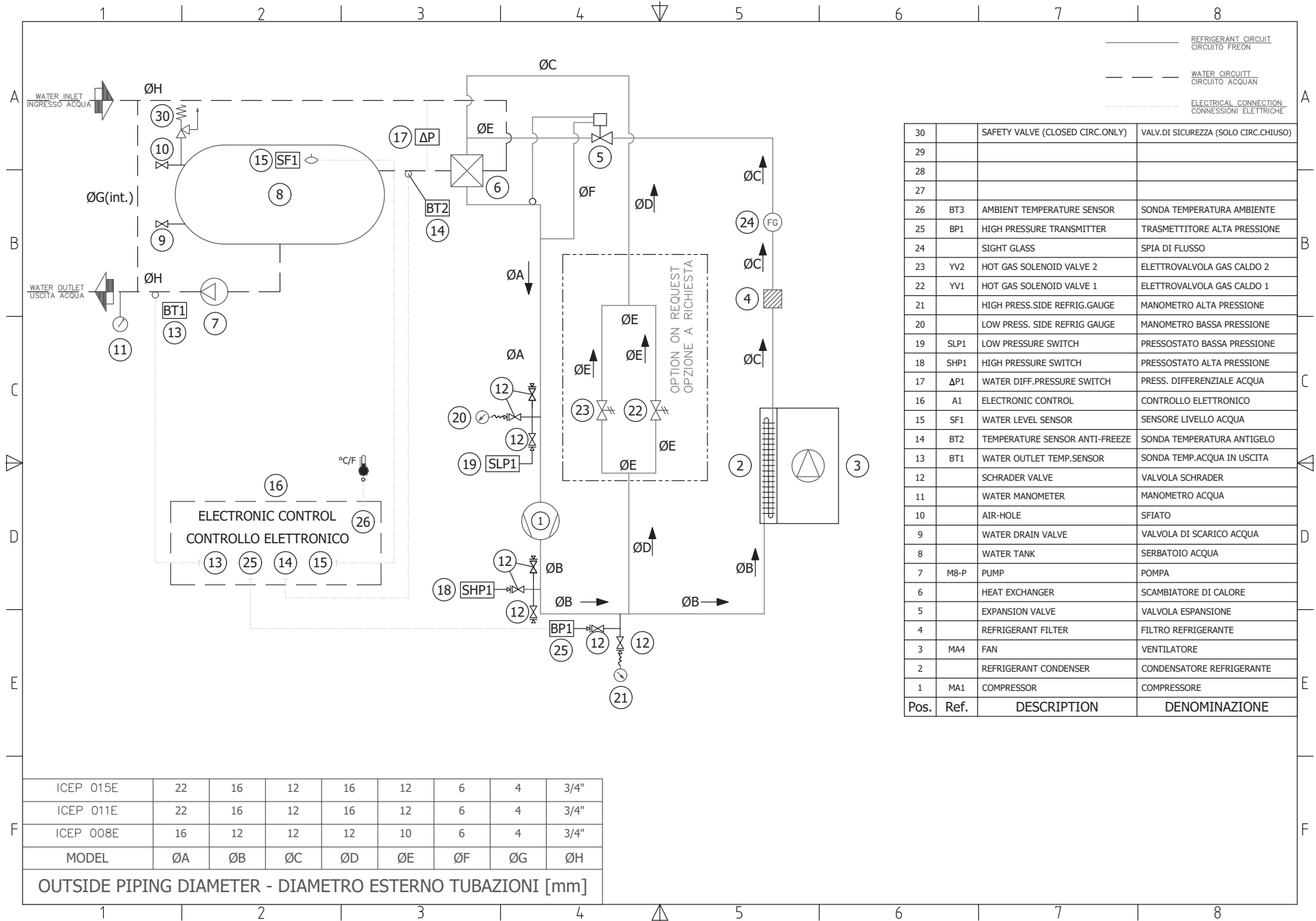

Circuit Diagram ICEP027E (air cond. A)

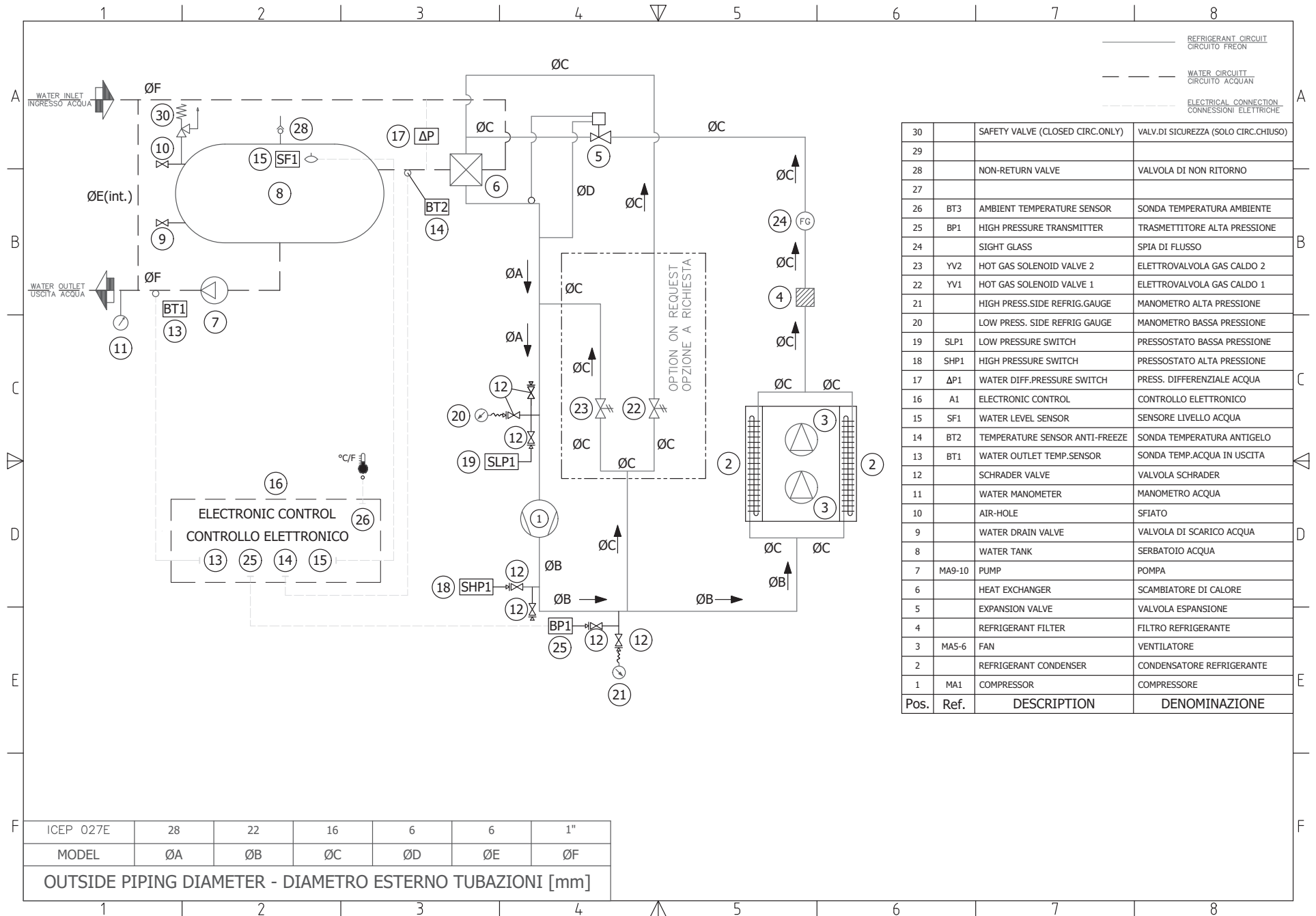

Circuit Diagram ICEP022E (water cond. W)

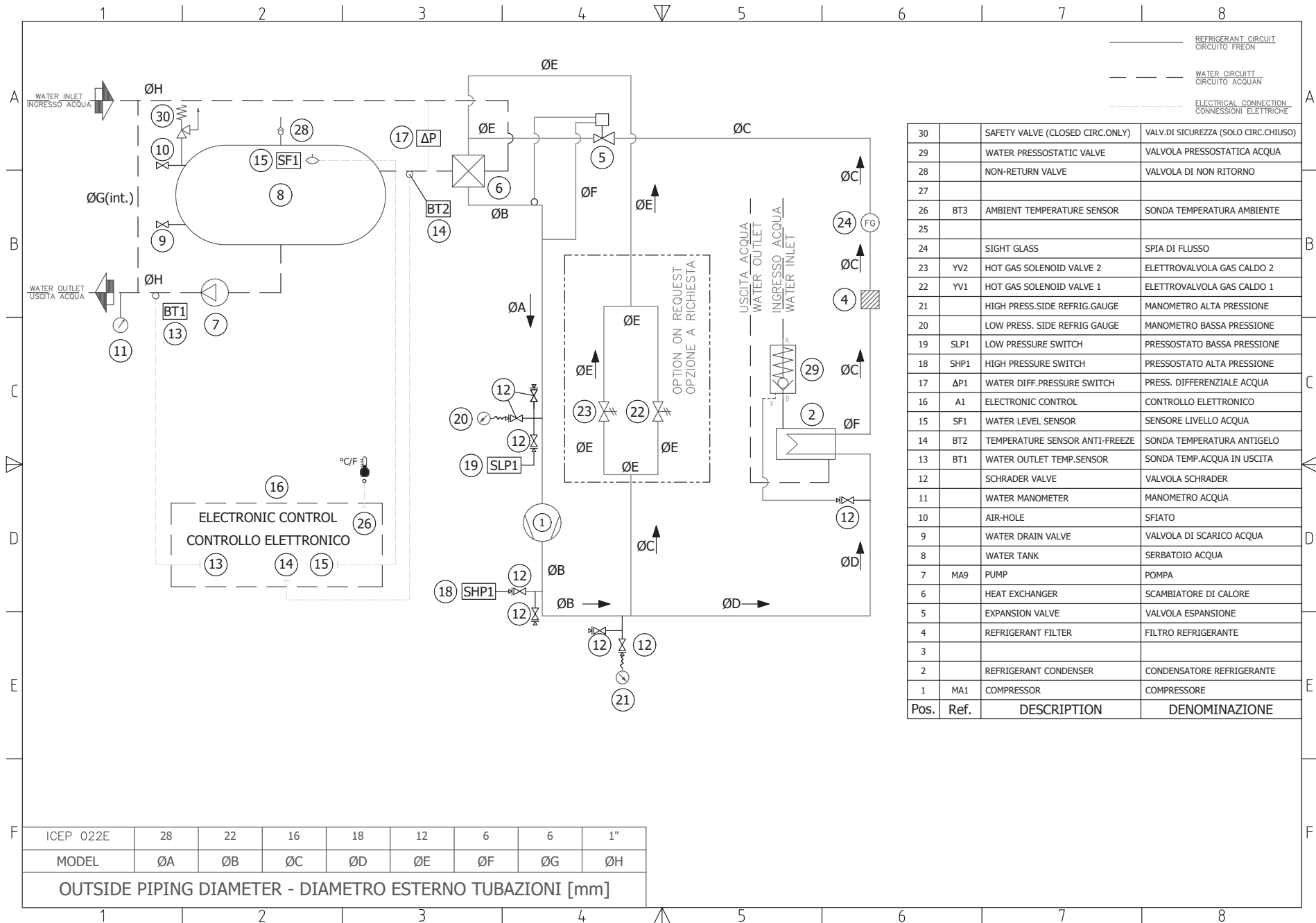

Circuit Diagram ICEP027E (water cond. W)

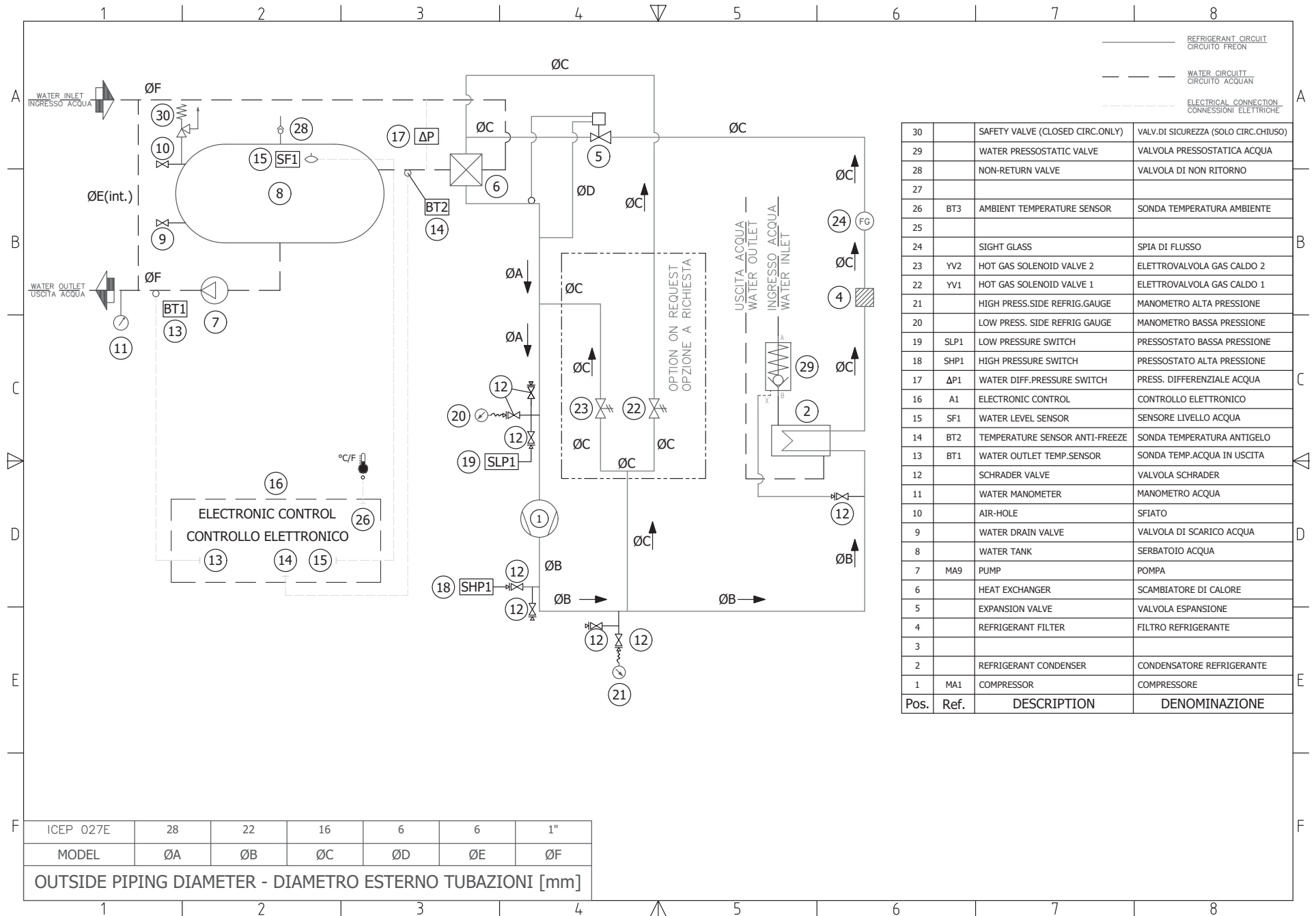

7.9 Wiring diagram ICEP008-015E (standard)

Sheet 1/11

MODEL MODELLO ICEP008-E	NOMINAL VOLTAGE TENSIONE NOMINALE Un (V) = 400			PHASES FASI Ph = 3			FREQUENCY FREQUENZA f (Hz) = 50			NOMINAL VOLTAGE TENSIONE NOMINALE Un (V) = 400			PHASES FASI Ph = 3			FREQUENCY FREQUENZA f (Hz) = 50			NOMINAL VOLTAGE TENSIONE NOMINALE Un (V) = 400V/3/50Hz											
	COMPRESSORS COMPRESSORI									FAN MOTOR ELETTROVENTILATORE									PUMP POMPA									MODEL - MODELLI ICEP008-E		
	SIGLA	FLA (A)	KW	LRA (A)	SIGLA	FLA (A)	KW	LRA (A)	SIGLA	FLA (A)	KW	LRA (A)	SIGLA	FLA (A)	KW	LRA (A)	MCA (A)	MOP (A)	FLA (A) Tot.											
MC1	4.5	2.5	45	MF1	0.46	0.23	2.3	MP1 (P15)	1.4	λ	0.71	7.3	8	15	6.36															
								MP1 (P30)	1.65	λ	0.88	10.3	8	15	6.61															
								MP1 (P50)	3.3	λ	1.77	27.4	10	15	8.26															

MODEL MODELLO ICEP011-E	NOMINAL VOLTAGE TENSIONE NOMINALE Un (V) = 400			PHASES FASI Ph = 3			FREQUENCY FREQUENZA f (Hz) = 50			NOMINAL VOLTAGE TENSIONE NOMINALE Un (V) = 400			PHASES FASI Ph = 3			FREQUENCY FREQUENZA f (Hz) = 50			NOMINAL VOLTAGE TENSIONE NOMINALE Un (V) = 400V/3/50Hz											
	COMPRESSORS COMPRESSORI									FAN MOTOR ELETTROVENTILATORE									PUMP POMPA									MODEL - MODELLI ICEP011-E		
	SIGLA	FLA (A)	KW	LRA (A)	SIGLA	FLA (A)	KW	LRA (A)	SIGLA	FLA (A)	KW	LRA (A)	SIGLA	FLA (A)	KW	LRA (A)	MCA (A)	MOP (A)	FLA (A) Tot.											
MC1	6.2	3.5	60	MF1	0.46	0.23	2.3	MP1 (P15)	1.4	λ	0.71	7.3	10	15	8.06															
								MP1 (P30)	1.65	λ	0.88	10.3	10	15	8.31															
								MP1 (P50)	3.3	λ	1.77	27.4	12	15	9.96															

MODEL MODELLO ICEP015-E	NOMINAL VOLTAGE TENSIONE NOMINALE Un (V) = 400			PHASES FASI Ph = 3			FREQUENCY FREQUENZA f (Hz) = 50			NOMINAL VOLTAGE TENSIONE NOMINALE Un (V) = 400			PHASES FASI Ph = 3			FREQUENCY FREQUENZA f (Hz) = 50			NOMINAL VOLTAGE TENSIONE NOMINALE Un (V) = 400V/3/50Hz											
	COMPRESSORS COMPRESSORI									FAN MOTOR ELETTROVENTILATORE									PUMP POMPA									MODEL - MODELLI ICEP015-E		
	SIGLA	FLA (A)	KW	LRA (A)	SIGLA	FLA (A)	KW	LRA (A)	SIGLA	FLA (A)	KW	LRA (A)	SIGLA	FLA (A)	KW	LRA (A)	MCA (A)	MOP (A)	FLA (A) Tot.											
MC1	9.7	5.4	82	MF1	1.02	0.455	5.1	MP1 (P15)	1.4	λ	0.71	7.3	15	20	12.12															
								MP1 (P30)	1.78	λ	0.98	13.1	15	20	12.5															
								MP1 (P50)	3.3	λ	1.77	27.4	17	25	14.02															

FOLGIO/SHEET	DESCRIZIONE	DESCRIPTION
1	Dati Tecnici	Technical Data
2	Dati Tecnici	Technical Data
3	Circuito di Potenza	Power Circuit
4	Circuito di Potenza	Power Circuit
5	Circuito Ausiliario	Auxiliary Circuit
6	Circuito Ausiliario	Auxiliary Circuit
7	Circuito Ausiliario	Auxiliary Circuit
8	Contatti Cliente	Terminal Block for User
9	Collegamenti Opzionali	Optional Terminal Block
10	Morsettiera	Terminal Block
11	Planimetria Quadro Elettrico	Electrical Lay-Out
12	Lista Componenti	Component List
13	Lista Componenti	Component List
14	Lista Componenti	Component List
15	Lista Componenti	Component List
16	Lista Componenti Parker	Component List - Parker

7.9 Wiring diagram ICEP008-015E (standard)

Sheet 2/11

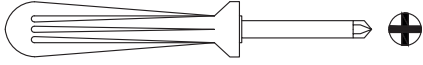
	1	2	3	4	5	6	7	8																																																
A			<table border="1"> <tr> <td>SUPPLY VOLTAGE TENSIONE ALIMENTAZIONE</td> <td>400V 3Ph 50Hz</td> </tr> <tr> <td>CONTROL VOLTAGE TENSIONE AUSILIARI</td> <td>0-24 VAC</td> </tr> <tr> <td>ENCLOSED TYPE PROTEZIONE IP</td> <td>IP54</td> </tr> <tr> <td>RESIDUAL CURRENT SWITCH INTER. AUTOMATICO DIFFERENZIALE</td> <td>RCBO Id=0,03A CLASS A</td> </tr> <tr> <td>SCCR</td> <td>--</td> </tr> <tr> <td>GROUNDING MESSA A TERRA</td> <td>Solidly grounded</td> </tr> <tr> <td>CABLES SIZE SUPPLY CAVI INGRESSO ALIMENTAZIONE</td> <td>See Table (MCA)</td> </tr> </table>		SUPPLY VOLTAGE TENSIONE ALIMENTAZIONE	400V 3Ph 50Hz	CONTROL VOLTAGE TENSIONE AUSILIARI	0-24 VAC	ENCLOSED TYPE PROTEZIONE IP	IP54	RESIDUAL CURRENT SWITCH INTER. AUTOMATICO DIFFERENZIALE	RCBO Id=0,03A CLASS A	SCCR	--	GROUNDING MESSA A TERRA	Solidly grounded	CABLES SIZE SUPPLY CAVI INGRESSO ALIMENTAZIONE	See Table (MCA)																																						
SUPPLY VOLTAGE TENSIONE ALIMENTAZIONE	400V 3Ph 50Hz																																																							
CONTROL VOLTAGE TENSIONE AUSILIARI	0-24 VAC																																																							
ENCLOSED TYPE PROTEZIONE IP	IP54																																																							
RESIDUAL CURRENT SWITCH INTER. AUTOMATICO DIFFERENZIALE	RCBO Id=0,03A CLASS A																																																							
SCCR	--																																																							
GROUNDING MESSA A TERRA	Solidly grounded																																																							
CABLES SIZE SUPPLY CAVI INGRESSO ALIMENTAZIONE	See Table (MCA)																																																							
B																																																								
C																																																								
D	<p style="text-align: center;">Tightening Torque</p>  <table border="1"> <thead> <tr> <th>Component</th> <th>Nm</th> <th>Lb*In</th> </tr> </thead> <tbody> <tr> <td>DILM9-10</td> <td>1,2000</td> <td>10,6000</td> </tr> <tr> <td>DILM15</td> <td>3.2000</td> <td>28.3000</td> </tr> <tr> <td>OT25F3</td> <td>0,8000</td> <td>7,0000</td> </tr> <tr> <td>BCH</td> <td>2,5000</td> <td>22,0000</td> </tr> <tr> <td>M4_8SFL</td> <td>0,8000</td> <td>7,0000</td> </tr> <tr> <td>FV1</td> <td>0,5000</td> <td>4,4000</td> </tr> <tr> <td>PKZM6.3 / 10</td> <td>1,7000</td> <td>15,0000</td> </tr> </tbody> </table>		Component	Nm	Lb*In	DILM9-10	1,2000	10,6000	DILM15	3.2000	28.3000	OT25F3	0,8000	7,0000	BCH	2,5000	22,0000	M4_8SFL	0,8000	7,0000	FV1	0,5000	4,4000	PKZM6.3 / 10	1,7000	15,0000			<table border="1"> <thead> <tr> <th colspan="3">TABELLA COLORI CAVI - TABLE ELECTRICAL CABLES (Norme EN 60204-1)</th> </tr> </thead> <tbody> <tr> <td>NERO - BLACK</td> <td>BK</td> <td>Conduttore di Potenza Principale in AC/DC - Main Power Circuits AC and DC</td> </tr> <tr> <td>AZZURRO - LIGHT BLUE</td> <td>BU</td> <td>Conduttore di Neutro - Neutral Conductor</td> </tr> <tr> <td>ROSSO - RED</td> <td>RD</td> <td>Circuiti di Comando in Corrente Alternata AC 12-24-230VAC - Control Circuits in AC 12-24-230VAC</td> </tr> <tr> <td>BLU SCURO - DARK BLUE</td> <td>DBU</td> <td>Circuiti di Comando in Corrente Continua DC 24VDC - Control Circuits in DC 24VDC</td> </tr> <tr> <td>ARANCIONE - ORANGE</td> <td>OG</td> <td>Circuiti Segnali in Tensione - Voltage Signal Circuits</td> </tr> <tr> <td>BIANCO - WHITE</td> <td>WH</td> <td>Circuiti di Misura - Measuring Circuits</td> </tr> <tr> <td>GIALLO-VERDE</td> <td>GNYE</td> <td>Conduttore di Terra - Grounded Conductors</td> </tr> </tbody> </table>		TABELLA COLORI CAVI - TABLE ELECTRICAL CABLES (Norme EN 60204-1)			NERO - BLACK	BK	Conduttore di Potenza Principale in AC/DC - Main Power Circuits AC and DC	AZZURRO - LIGHT BLUE	BU	Conduttore di Neutro - Neutral Conductor	ROSSO - RED	RD	Circuiti di Comando in Corrente Alternata AC 12-24-230VAC - Control Circuits in AC 12-24-230VAC	BLU SCURO - DARK BLUE	DBU	Circuiti di Comando in Corrente Continua DC 24VDC - Control Circuits in DC 24VDC	ARANCIONE - ORANGE	OG	Circuiti Segnali in Tensione - Voltage Signal Circuits	BIANCO - WHITE	WH	Circuiti di Misura - Measuring Circuits	GIALLO-VERDE	GNYE	Conduttore di Terra - Grounded Conductors		
Component	Nm	Lb*In																																																						
DILM9-10	1,2000	10,6000																																																						
DILM15	3.2000	28.3000																																																						
OT25F3	0,8000	7,0000																																																						
BCH	2,5000	22,0000																																																						
M4_8SFL	0,8000	7,0000																																																						
FV1	0,5000	4,4000																																																						
PKZM6.3 / 10	1,7000	15,0000																																																						
TABELLA COLORI CAVI - TABLE ELECTRICAL CABLES (Norme EN 60204-1)																																																								
NERO - BLACK	BK	Conduttore di Potenza Principale in AC/DC - Main Power Circuits AC and DC																																																						
AZZURRO - LIGHT BLUE	BU	Conduttore di Neutro - Neutral Conductor																																																						
ROSSO - RED	RD	Circuiti di Comando in Corrente Alternata AC 12-24-230VAC - Control Circuits in AC 12-24-230VAC																																																						
BLU SCURO - DARK BLUE	DBU	Circuiti di Comando in Corrente Continua DC 24VDC - Control Circuits in DC 24VDC																																																						
ARANCIONE - ORANGE	OG	Circuiti Segnali in Tensione - Voltage Signal Circuits																																																						
BIANCO - WHITE	WH	Circuiti di Misura - Measuring Circuits																																																						
GIALLO-VERDE	GNYE	Conduttore di Terra - Grounded Conductors																																																						
E																																																								
F																																																								

7.9 Wiring diagram ICEP008-015E (standard)

Sheet 3/11

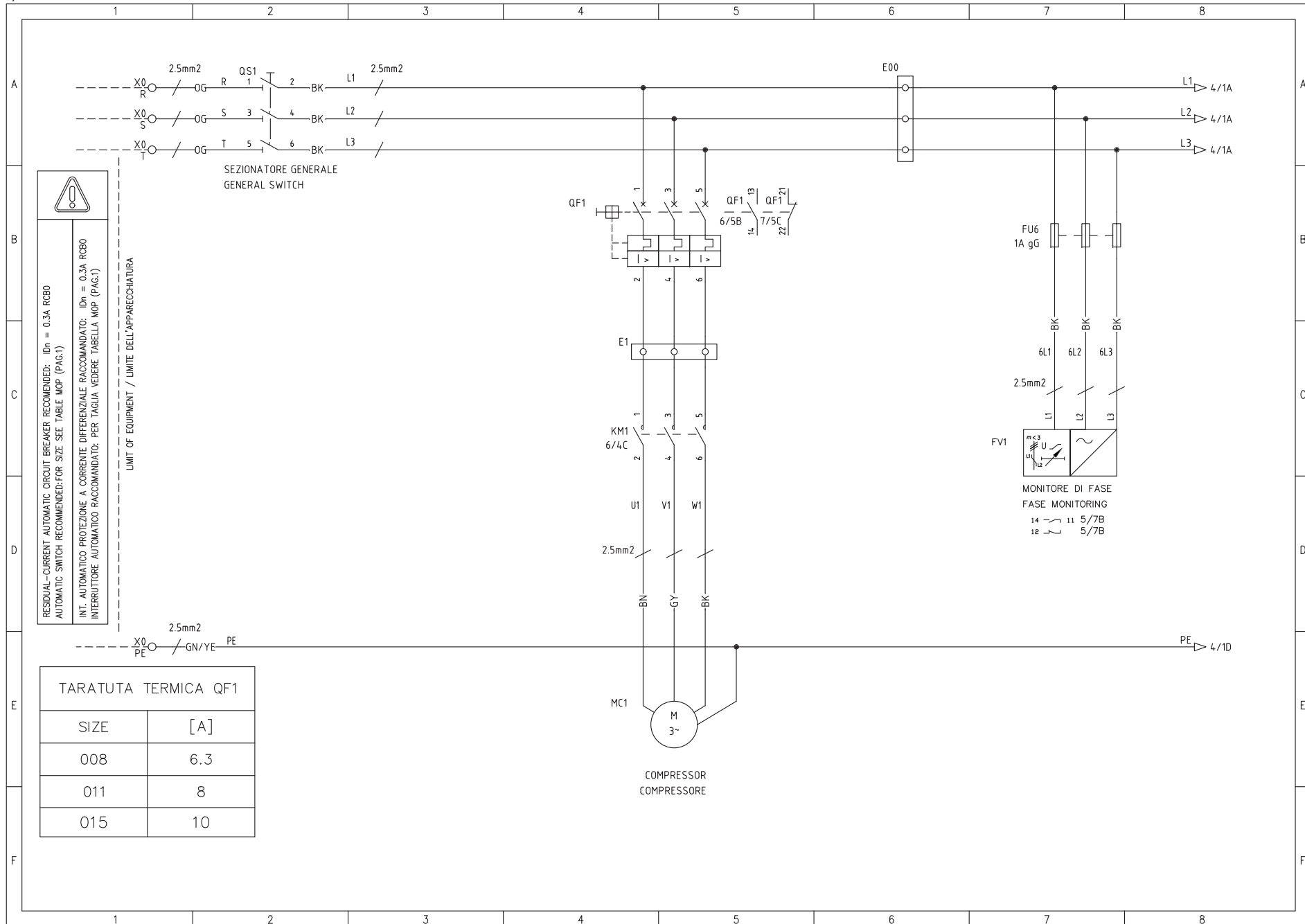

7.9 Wiring diagram ICEP008-015E (standard)

Sheet 4/11

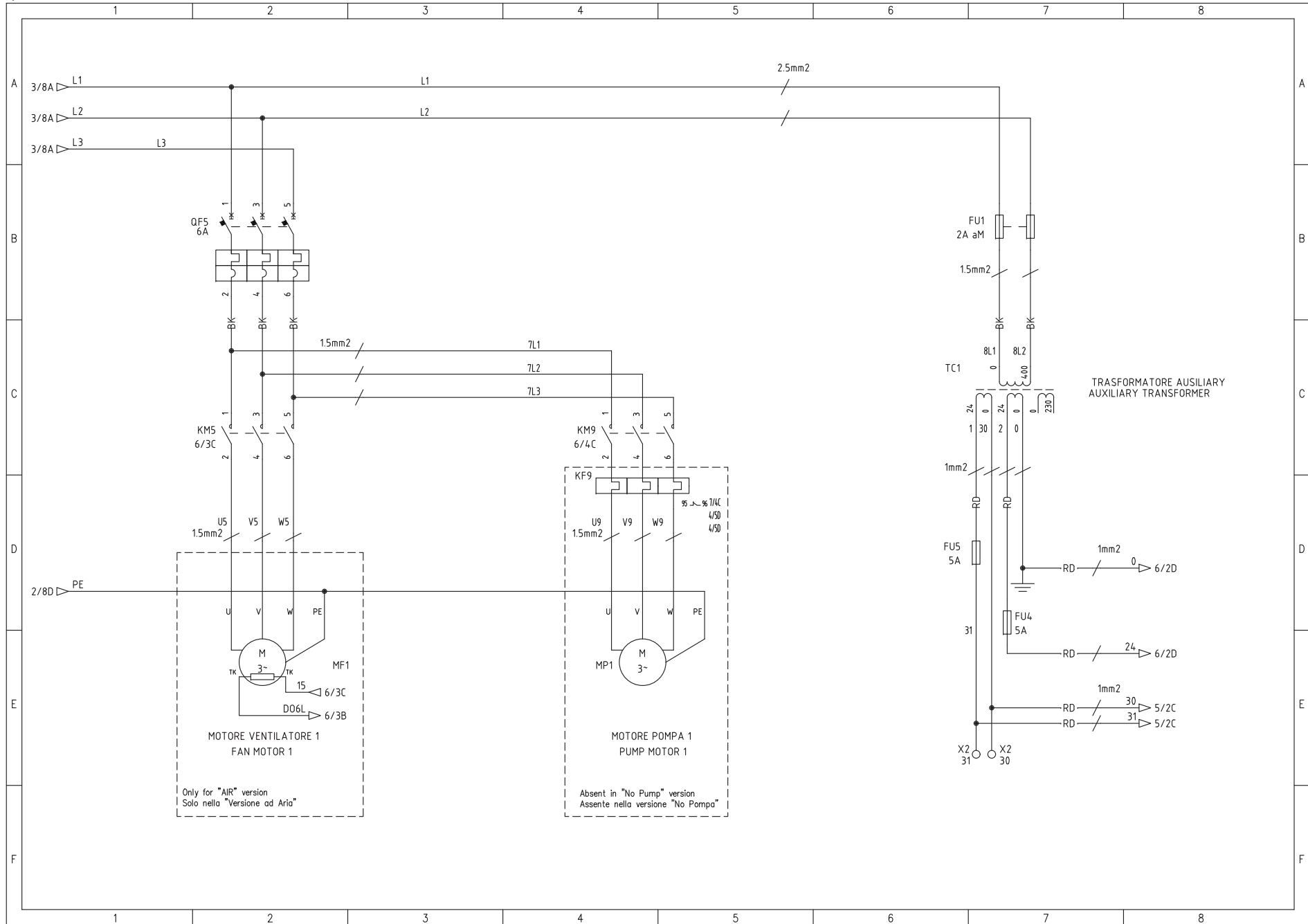

7.9 Wiring diagram ICEP008-015E (standard)

Sheet 5/11

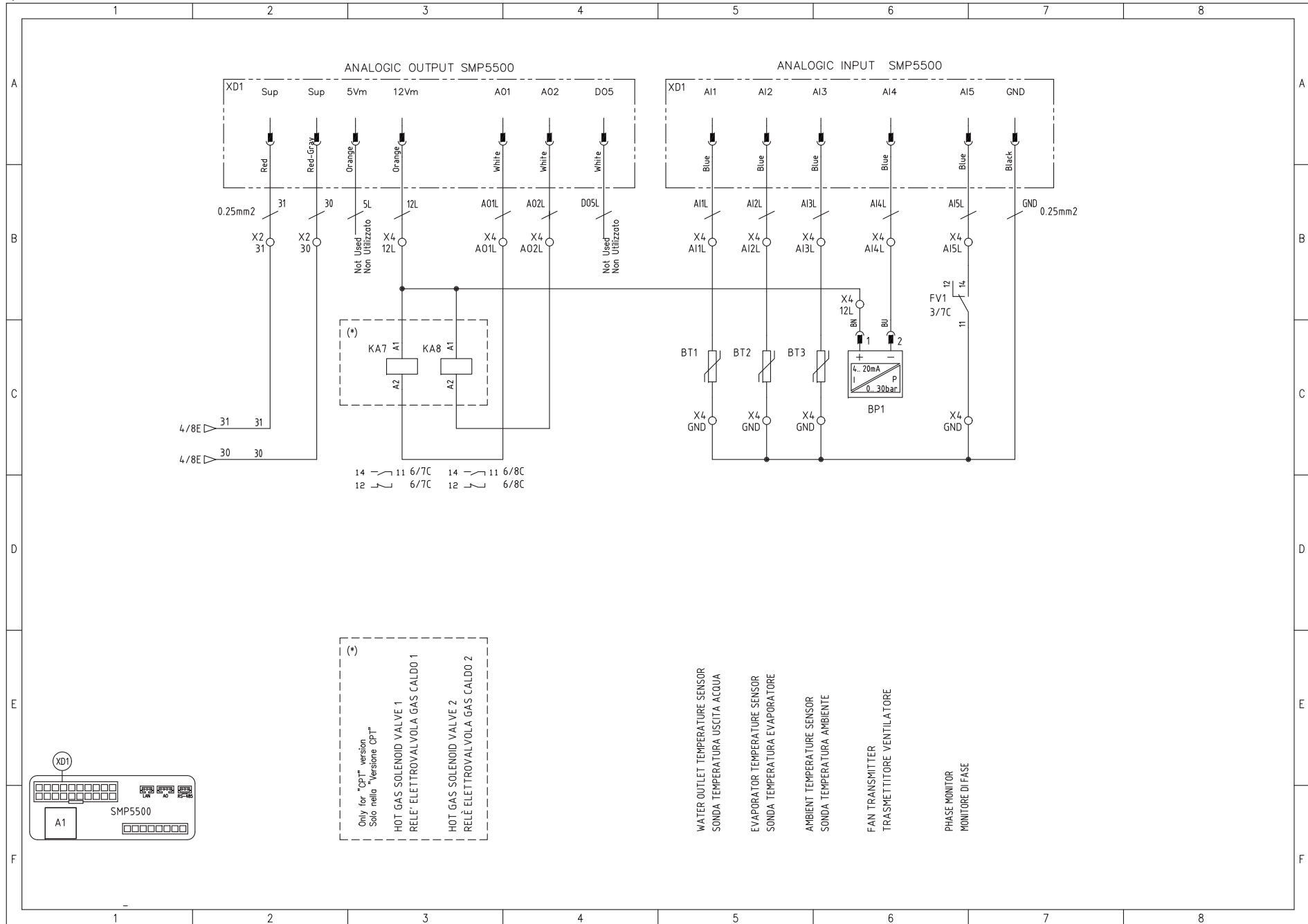

7.9 Wiring diagram ICEP008-015E (standard)

Sheet 6/11

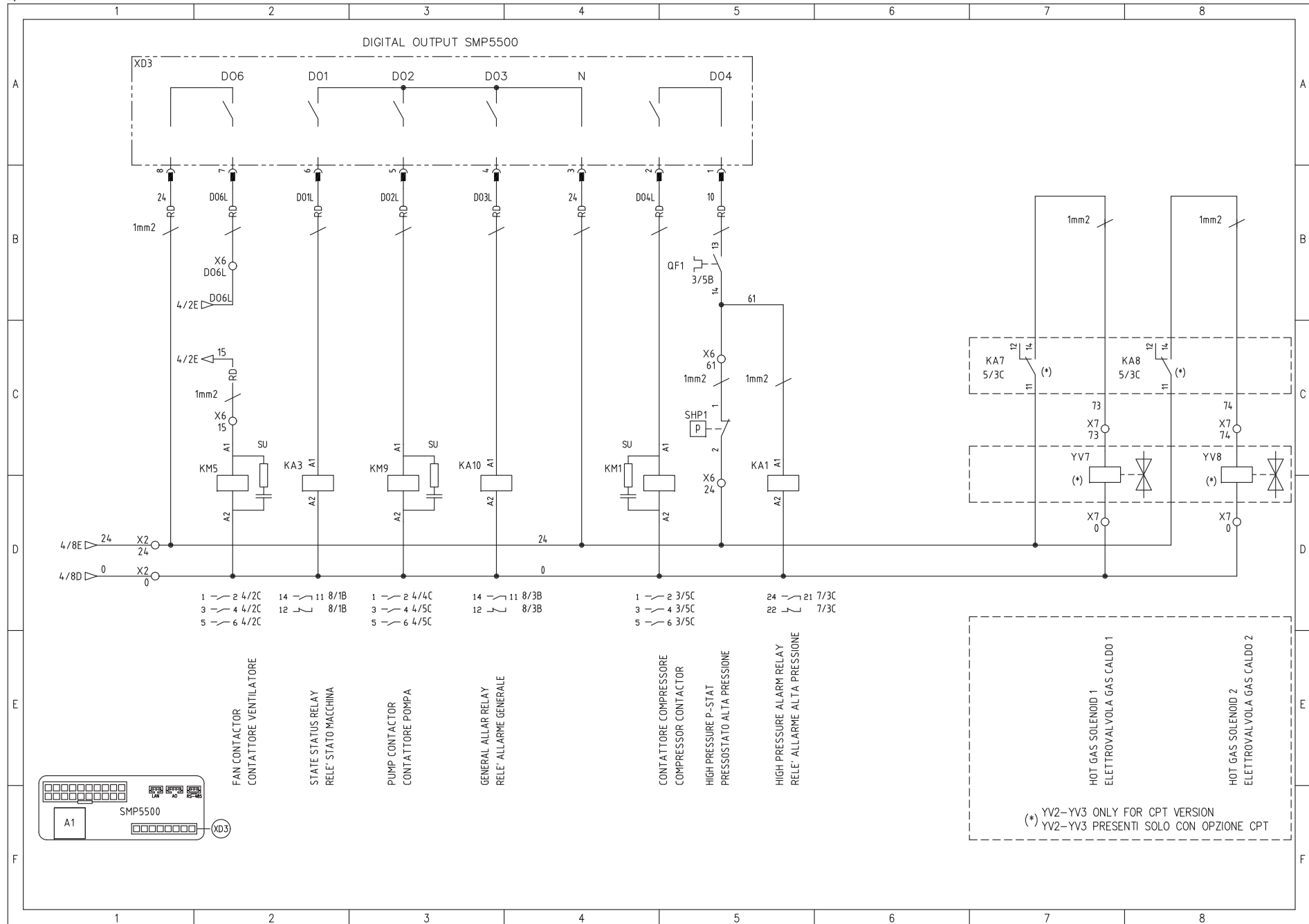

7.9 Wiring diagram ICEP008-015E (standard)

Sheet 7/11

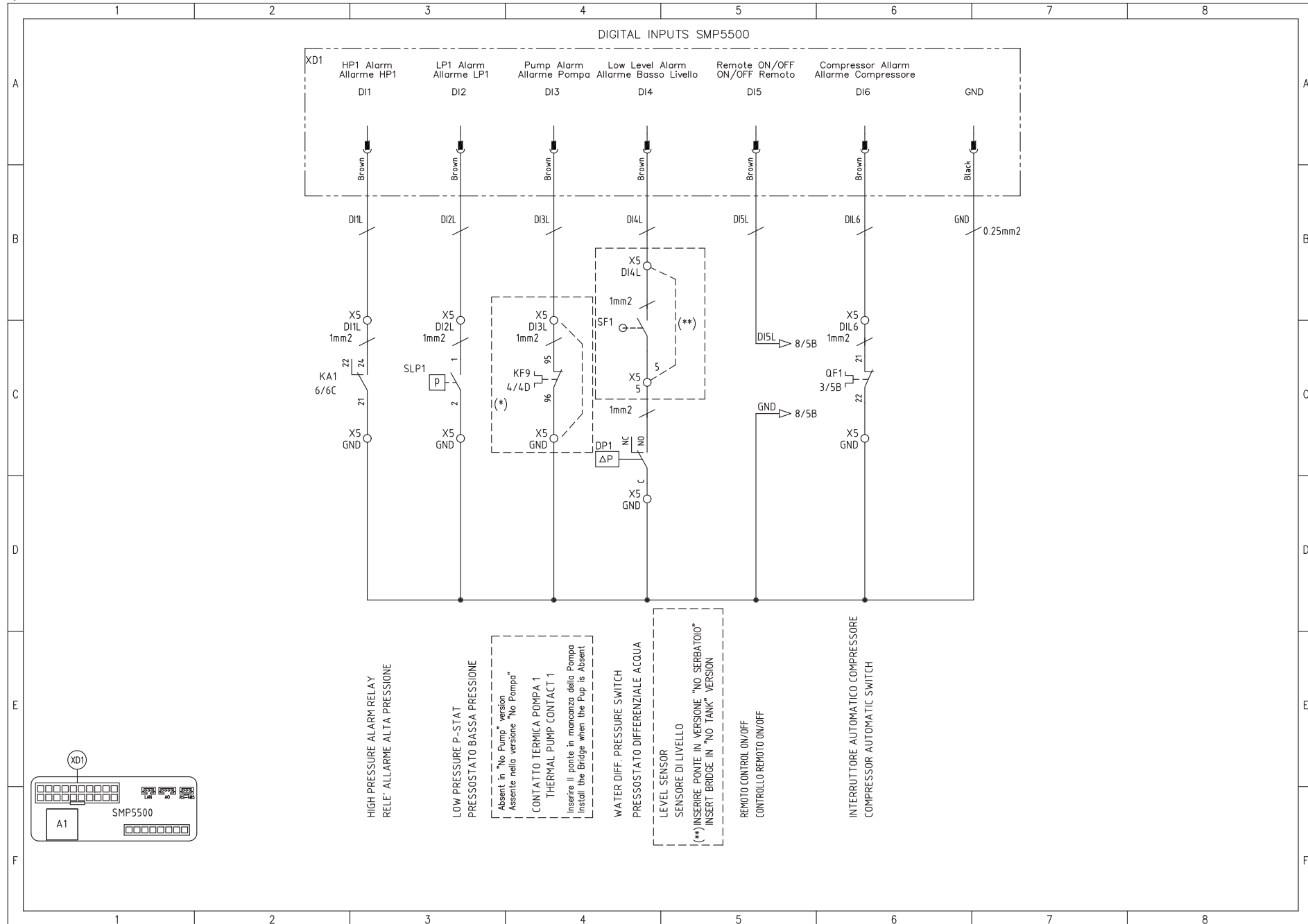

7.9 Wiring diagram ICEP008-015E (standard)

Sheet 8/11

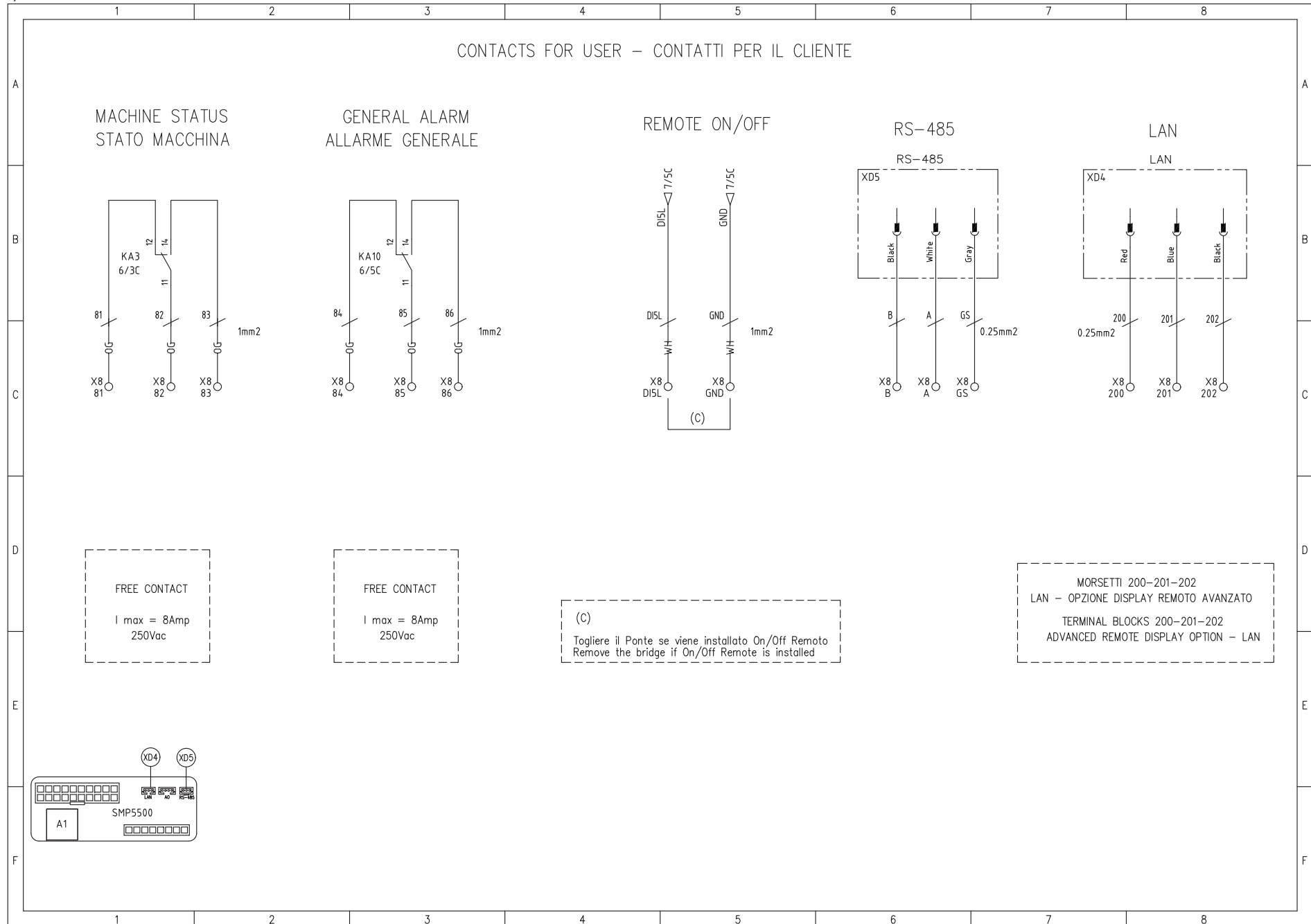

7.9 Wiring diagram ICEP008-015E (standard)

Sheet 9/11

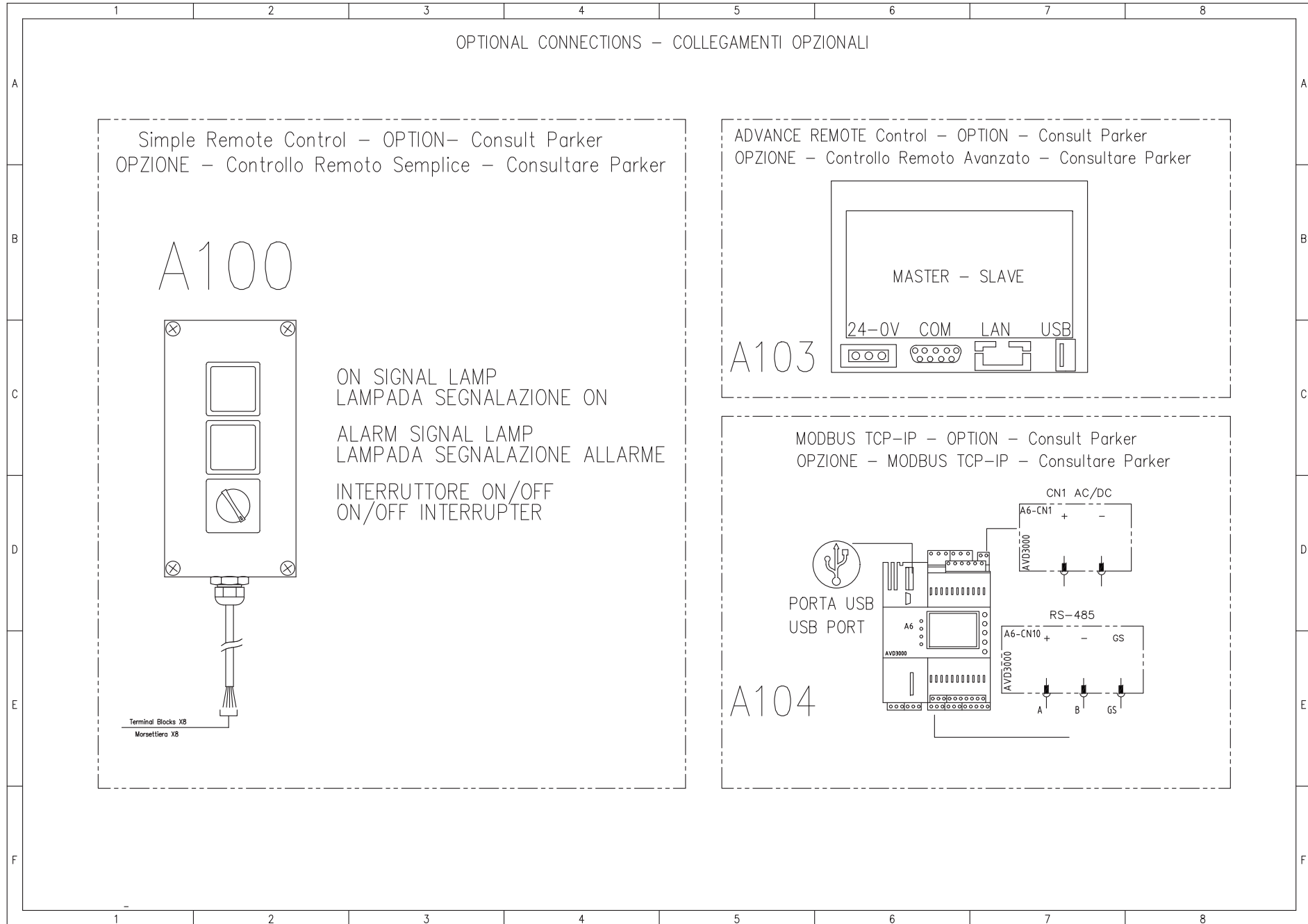

7.9 Wiring diagram ICEP008-015E (standard)

Sheet 10/11

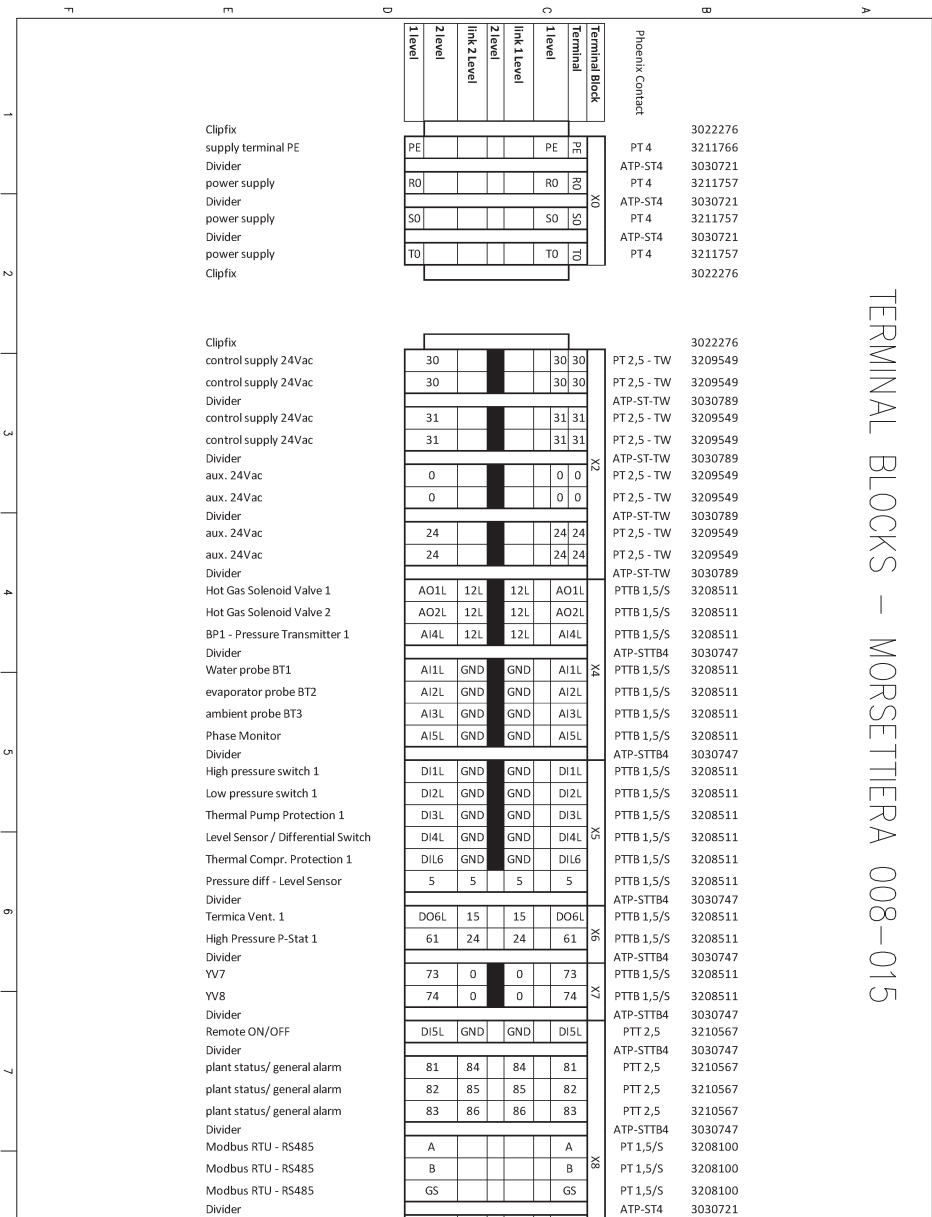

TERMINAL BLOCKS – MORSETTERA 008-015

7.9 Wiring diagram ICEP008-015E (standard)

Sheet 11/11

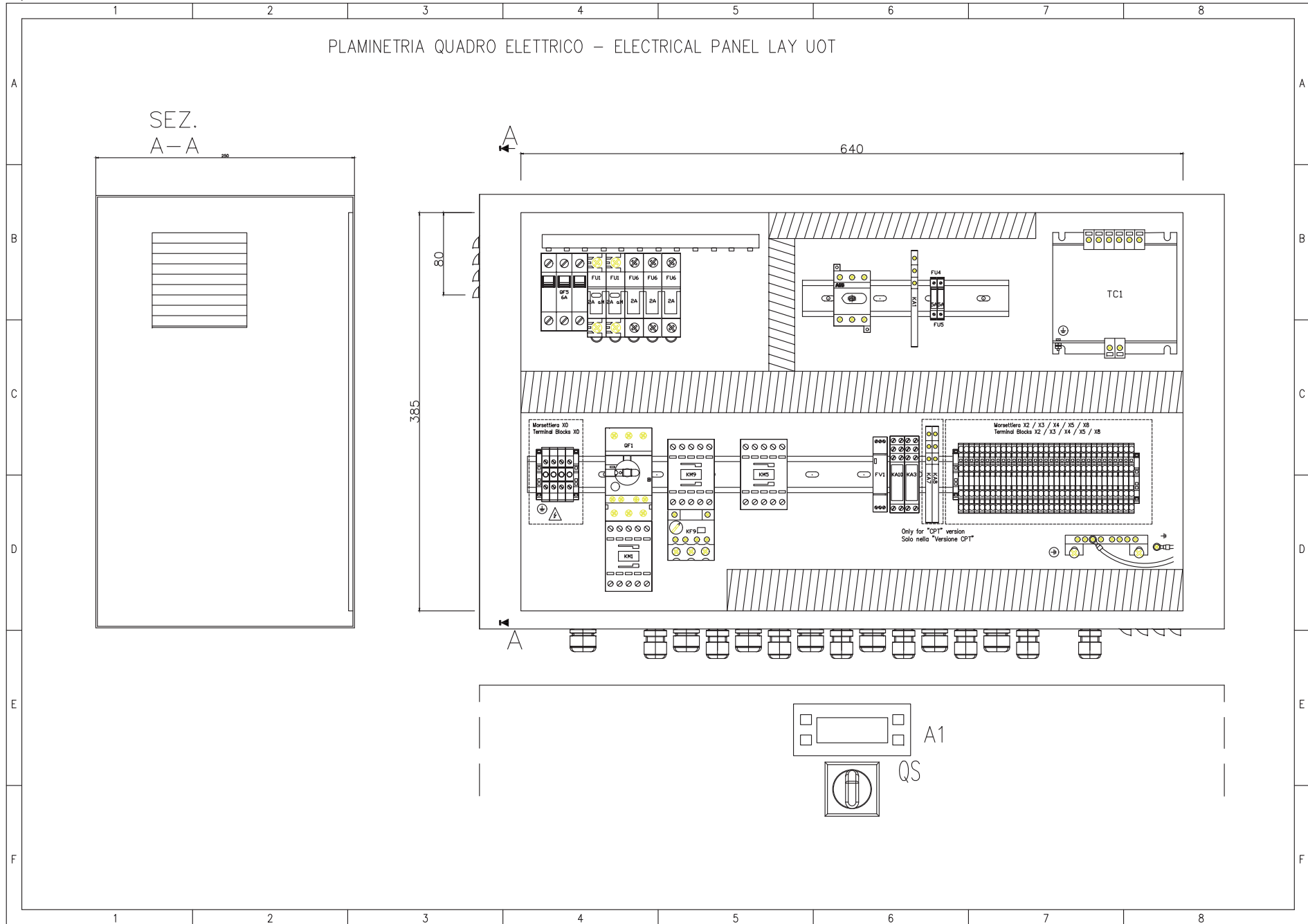

Wiring diagram ICEP022-027E (standard)

Sheet 1/11

MODEL MODELLO ICEP022-E	NOMINAL VOLTAGE TENSIONE NOMINALE Un (V) = 400				PHASES FASI Ph = 3				FREQUENCY FREQUENZA f (Hz) = 50				NOMINAL VOLTAGE TENSIONE NOMINALE Un (V) = 400				PHASES FASI Ph = 3				FREQUENCY FREQUENZA f (Hz) = 50				NOMINAL VOLTAGE TENSIONE NOMINALE Un (V) = 400V/3/50Hz			
	COMPRESSORS COMPRESSORI												FAN MOTOR ELETTROVENTILATORE								PUMP POMPA				MODEL - MODELLI ICEP022-E			
	SIGLA	FLA (A)	KW	LRA (A)	SIGLA	FLA (A)	KW	LRA (A)	SIGLA	FLA (A)	KW	LRA (A)	SIGLA	FLA (A)	MCA (A)	MOP (A)	FLA (A) Tot.											
MC1	11.8	6.5	95	MF1	1,02 λ	0,455	5.1	MP1 (P15)	1.4	0.71	7.3	19	25	15.24														
				MF2	1,02 λ	0,455	5.1	MP1 (P30)	2.37	1.28	19.7	20	30	16.21														
								MP1 (P50)	3.3	1.77	27.4	21	30	17.14														

MODEL MODELLO ICEP027-E	NOMINAL VOLTAGE TENSIONE NOMINALE Un (V) = 400				PHASES FASI Ph = 3				FREQUENCY FREQUENZA f (Hz) = 50				NOMINAL VOLTAGE TENSIONE NOMINALE Un (V) = 400				PHASES FASI Ph = 3				FREQUENCY FREQUENZA f (Hz) = 50				NOMINAL VOLTAGE TENSIONE NOMINALE Un (V) = 400V/3/50Hz			
	COMPRESSORS COMPRESSORI												FAN MOTOR ELETTROVENTILATORE								PUMP POMPA				MODEL - MODELLI ICEP027-E			
	SIGLA	FLA (A)	KW	LRA (A)	SIGLA	FLA (A)	KW	LRA (A)	SIGLA	FLA (A)	KW	LRA (A)	SIGLA	FLA (A)	MCA (A)	MOP (A)	FLA (A) Tot.											
MC1	18.3	8.7	140	MF1	1,02 λ	0,455	5.1	MP1 (P15)	1.7	0.91	11.8	27	40	22.04														
				MF2	1,02 λ	0,455	5.1	MP1 (P30)	2.37	1.28	19.7	28	45	22.71														
								MP1 (P50)	4.7	2.55	38.4	30	45	25.04														

FOLGIO/SHEET	DESCRIZIONE	DESCRIPTION
1	Dati Tecnici	Technical Data
2	Dati Tecnici	Technical Data
3	Circuito di Potenza	Power Circuit
4	Circuito di Potenza	Power Circuit
5	Circuito Ausiliario	Auxiliary Circuit
6	Circuito Ausiliario	Auxiliary Circuit
7	Circuito Ausiliario	Auxiliary Circuit
8	Contatti Cliente	Terminal Block for User
9	Collegamenti Opzionali	Optional Terminal Block
10	Morsettiere	Terminal Block
11	Planimetria Quadro Elettrico	Electrical Lay-Out
12	Lista Componenti	Component List
13	Lista Componenti	Component List
14	Lista Componenti	Component List
15	Lista Componenti	Component List
16	Lista Componenti Parker	Component List - Parker

Wiring diagram ICEP022-027E (standard)

Sheet 2/11

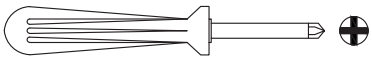
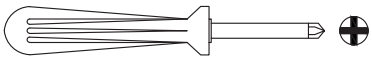
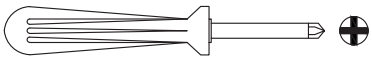
	1	2	3	4	5	6	7	8																																																						
A			<table border="1"> <tr> <td>SUPPLY VOLTAGE TENSIONE ALIMENTAZIONE</td> <td>400V 3Ph 50Hz</td> </tr> <tr> <td>CONTROL VOLTAGE TENSIONE AUSILIARI</td> <td>0-24 VAC</td> </tr> <tr> <td>ENCLOSED TYPE PROTEZIONE IP</td> <td>IP54</td> </tr> <tr> <td>RESIDUAL CURRENT SWITCH INTER. AUTOMATICO DIFFERENZIALE</td> <td>RCBO Id=0,03A CLASS A</td> </tr> <tr> <td>SCCR</td> <td>--</td> </tr> <tr> <td>GROUNDING MESSA A TERRA</td> <td>Solidly grounded</td> </tr> <tr> <td>CABLES SIZE SUPPLY CAVI INGRESSO ALIMENTAZIONE</td> <td>See Table (MCA)</td> </tr> </table>		SUPPLY VOLTAGE TENSIONE ALIMENTAZIONE	400V 3Ph 50Hz	CONTROL VOLTAGE TENSIONE AUSILIARI	0-24 VAC	ENCLOSED TYPE PROTEZIONE IP	IP54	RESIDUAL CURRENT SWITCH INTER. AUTOMATICO DIFFERENZIALE	RCBO Id=0,03A CLASS A	SCCR	--	GROUNDING MESSA A TERRA	Solidly grounded	CABLES SIZE SUPPLY CAVI INGRESSO ALIMENTAZIONE	See Table (MCA)																																												
SUPPLY VOLTAGE TENSIONE ALIMENTAZIONE	400V 3Ph 50Hz																																																													
CONTROL VOLTAGE TENSIONE AUSILIARI	0-24 VAC																																																													
ENCLOSED TYPE PROTEZIONE IP	IP54																																																													
RESIDUAL CURRENT SWITCH INTER. AUTOMATICO DIFFERENZIALE	RCBO Id=0,03A CLASS A																																																													
SCCR	--																																																													
GROUNDING MESSA A TERRA	Solidly grounded																																																													
CABLES SIZE SUPPLY CAVI INGRESSO ALIMENTAZIONE	See Table (MCA)																																																													
B																																																														
C																																																														
D	<table border="1"> <tr> <th colspan="3">Tightening Torque</th> </tr> <tr> <td colspan="3" style="text-align: center;">  </td> </tr> <tr> <th>Component</th> <th>Nm</th> <th>Lb*In</th> </tr> <tr> <td>DILM9-10</td> <td>1,2000</td> <td>10,6000</td> </tr> <tr> <td>DILM15/25</td> <td>1,2000</td> <td>10,6000</td> </tr> <tr> <td>OT063F3</td> <td>0,8000</td> <td>7</td> </tr> <tr> <td>BCH</td> <td>2,5000</td> <td>22,0000</td> </tr> <tr> <td>M4_8SFL</td> <td>0,8000</td> <td>7,0000</td> </tr> <tr> <td>FV1</td> <td>0,5000</td> <td>4,4000</td> </tr> <tr> <td>PKZM16 / 20</td> <td>1,7000</td> <td>15,0000</td> </tr> </table>		Tightening Torque						Component	Nm	Lb*In	DILM9-10	1,2000	10,6000	DILM15/25	1,2000	10,6000	OT063F3	0,8000	7	BCH	2,5000	22,0000	M4_8SFL	0,8000	7,0000	FV1	0,5000	4,4000	PKZM16 / 20	1,7000	15,0000	<table border="1"> <tr> <th colspan="3">TABELLA COLORI CAVI - TABLE ELECTRICAL CABLES (Norme EN 60204-1)</th> </tr> <tr> <td>NERO - BLACK</td> <td>BK</td> <td>Conduttore di Potenza Principale in AC/DC - Main Power Circuits AC and DC</td> </tr> <tr> <td>AZZURRO - LIGHT BLUE</td> <td>BU</td> <td>Conduttore di Neutro - Neutral Conductor</td> </tr> <tr> <td>ROSSO - RED</td> <td>RD</td> <td>Circuiti di Comando in Corrente Alternata AC 12-24-230VAC - Control Circuits in AC 12-24-230VAC</td> </tr> <tr> <td>BLU SCURO - DARK BLUE</td> <td>DBU</td> <td>Circuiti di Comando in Corrente Continua DC 24VDC - Control Circuits in DC 24VDC</td> </tr> <tr> <td>ARANCIONE - ORANGE</td> <td>OG</td> <td>Circuiti Segnali in Tensione - Voltage Signal Circuits</td> </tr> <tr> <td>BIANCO - WHITE</td> <td>WH</td> <td>Circuiti di Misura - Measuring Circuits</td> </tr> <tr> <td>GIALLO-VERDE</td> <td>GNYE</td> <td>Conduttore di Terra - Grounded Conductors</td> </tr> </table>		TABELLA COLORI CAVI - TABLE ELECTRICAL CABLES (Norme EN 60204-1)			NERO - BLACK	BK	Conduttore di Potenza Principale in AC/DC - Main Power Circuits AC and DC	AZZURRO - LIGHT BLUE	BU	Conduttore di Neutro - Neutral Conductor	ROSSO - RED	RD	Circuiti di Comando in Corrente Alternata AC 12-24-230VAC - Control Circuits in AC 12-24-230VAC	BLU SCURO - DARK BLUE	DBU	Circuiti di Comando in Corrente Continua DC 24VDC - Control Circuits in DC 24VDC	ARANCIONE - ORANGE	OG	Circuiti Segnali in Tensione - Voltage Signal Circuits	BIANCO - WHITE	WH	Circuiti di Misura - Measuring Circuits	GIALLO-VERDE	GNYE	Conduttore di Terra - Grounded Conductors				
Tightening Torque																																																														
																																																														
Component	Nm	Lb*In																																																												
DILM9-10	1,2000	10,6000																																																												
DILM15/25	1,2000	10,6000																																																												
OT063F3	0,8000	7																																																												
BCH	2,5000	22,0000																																																												
M4_8SFL	0,8000	7,0000																																																												
FV1	0,5000	4,4000																																																												
PKZM16 / 20	1,7000	15,0000																																																												
TABELLA COLORI CAVI - TABLE ELECTRICAL CABLES (Norme EN 60204-1)																																																														
NERO - BLACK	BK	Conduttore di Potenza Principale in AC/DC - Main Power Circuits AC and DC																																																												
AZZURRO - LIGHT BLUE	BU	Conduttore di Neutro - Neutral Conductor																																																												
ROSSO - RED	RD	Circuiti di Comando in Corrente Alternata AC 12-24-230VAC - Control Circuits in AC 12-24-230VAC																																																												
BLU SCURO - DARK BLUE	DBU	Circuiti di Comando in Corrente Continua DC 24VDC - Control Circuits in DC 24VDC																																																												
ARANCIONE - ORANGE	OG	Circuiti Segnali in Tensione - Voltage Signal Circuits																																																												
BIANCO - WHITE	WH	Circuiti di Misura - Measuring Circuits																																																												
GIALLO-VERDE	GNYE	Conduttore di Terra - Grounded Conductors																																																												
E																																																														
F																																																														
	1	2	3	4	5	6	7	8																																																						

Wiring diagram ICEP022-027E (standard)

Sheet 3/11

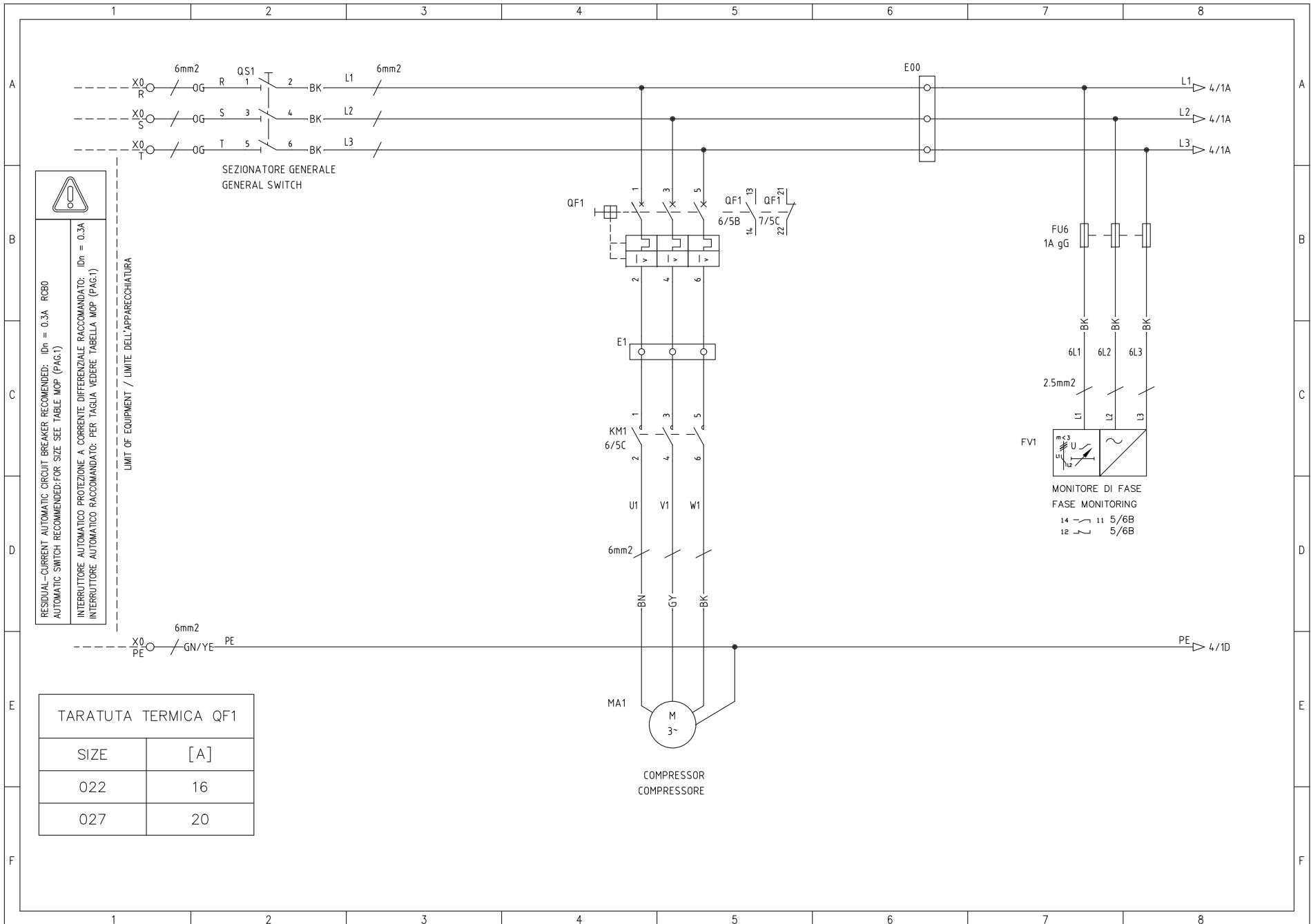

**RESIDUAL-CURRENT AUTOMATIC CIRCUIT BREAKER RECOMMENDED: I_{dn} = 0.3A RCBO
AUTOMATIC SWITCH RECOMMENDED: FOR SIZE SEE TABLE MOP (PAG.1)**

**INTERRUTTORE AUTOMATICO PROTEZIONE A CORRENTE DIFFERENZIALE RACCOMANDATO: I_{dn} = 0.3A
INTERRUTTORE AUTOMATICO RACCOMANDATO: PER TAGLIA VEDERE TABELLA MOP (PAG.1)**

LIMIT OF EQUIPMENT / LIMITE DELL'APPARECCHIATURA

TARATURA TERMICA QF1	
SIZE	[A]
022	16
027	20

Wiring diagram ICEP022-027E (standard)

Sheet 4/11

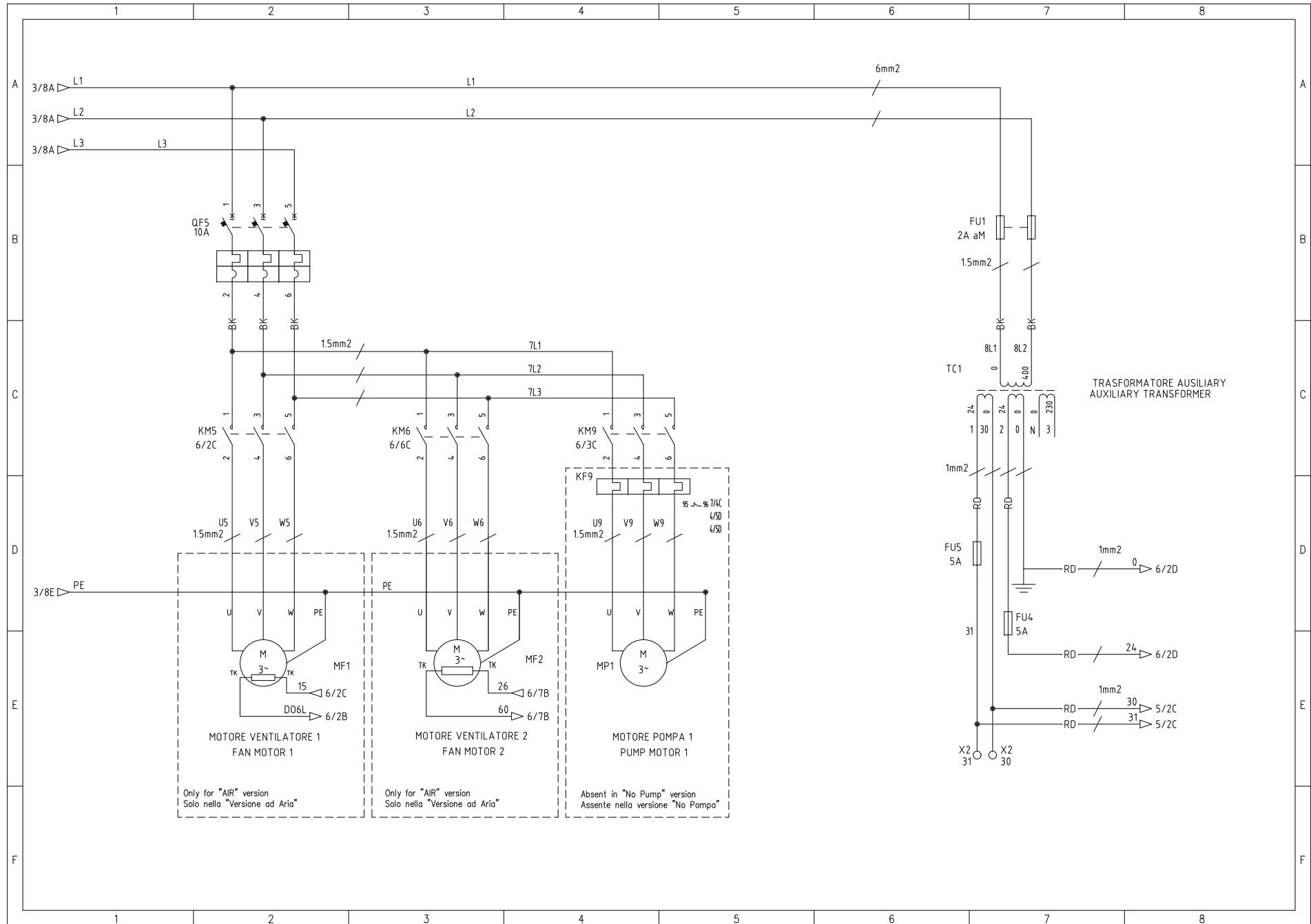

Wiring diagram ICEP022-027E (standard)

Sheet 5/11

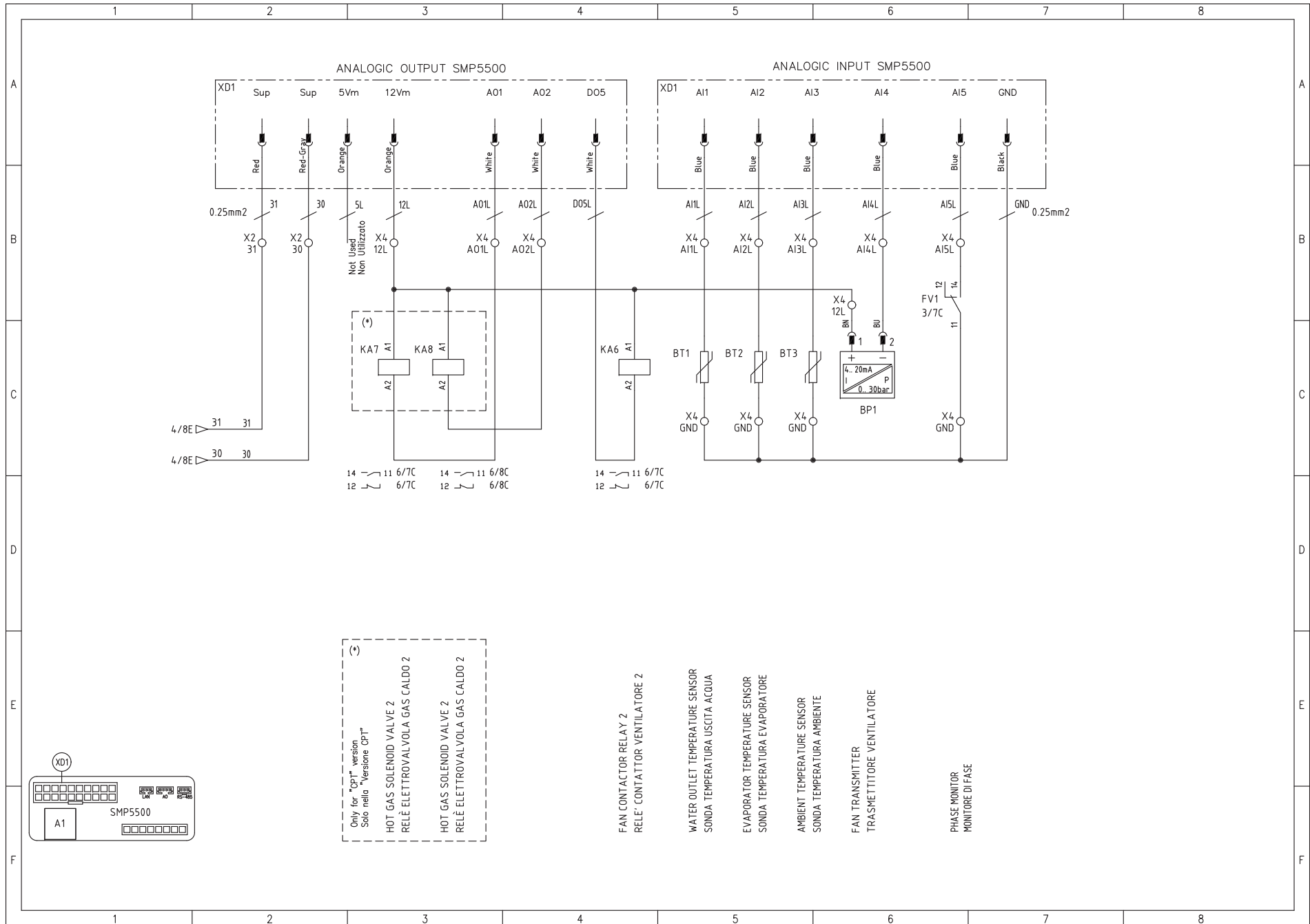

Wiring diagram ICEP022-027E (standard)

Sheet 6/11

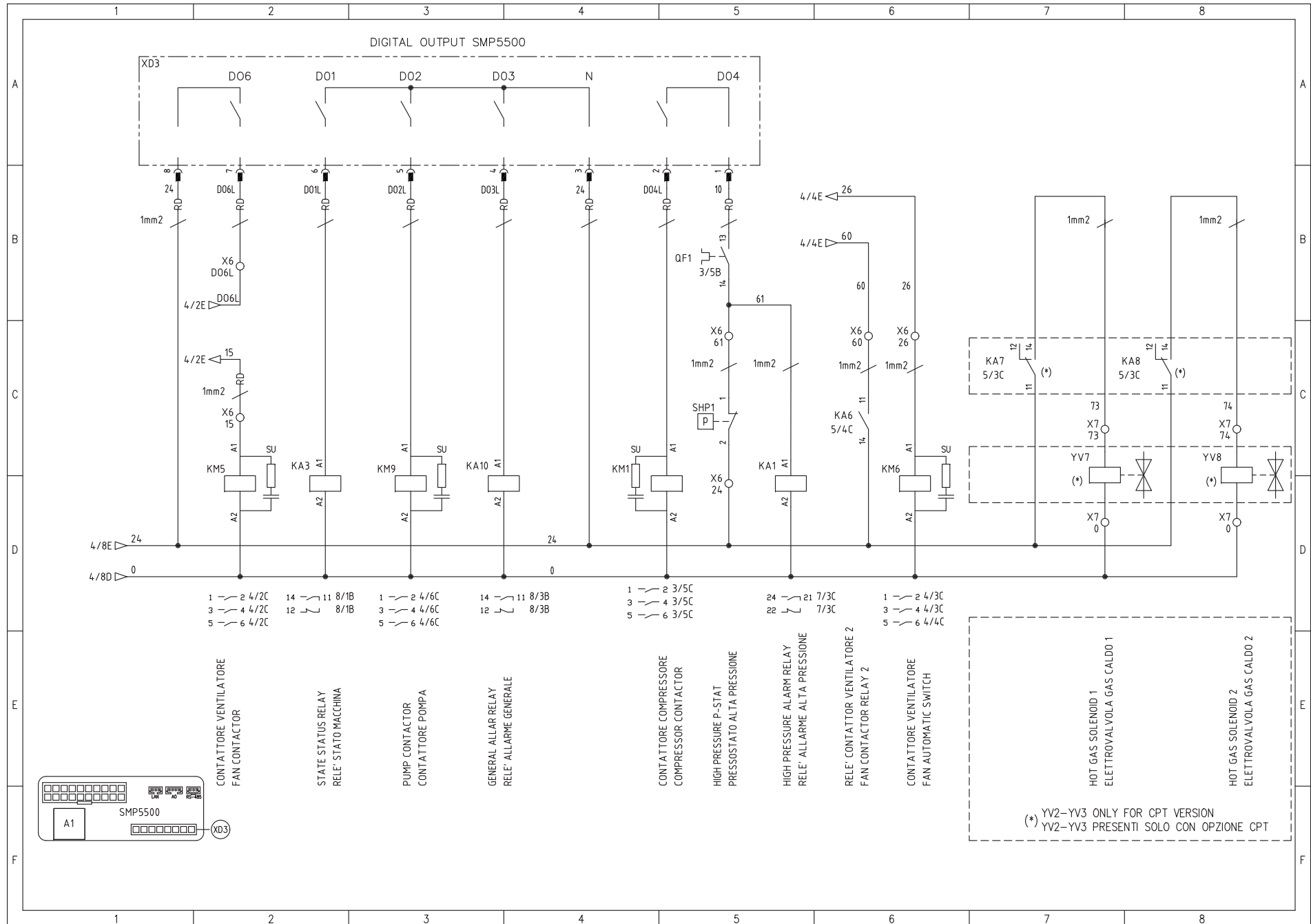

Wiring diagram ICEP022-027E (standard)

Sheet 7/11

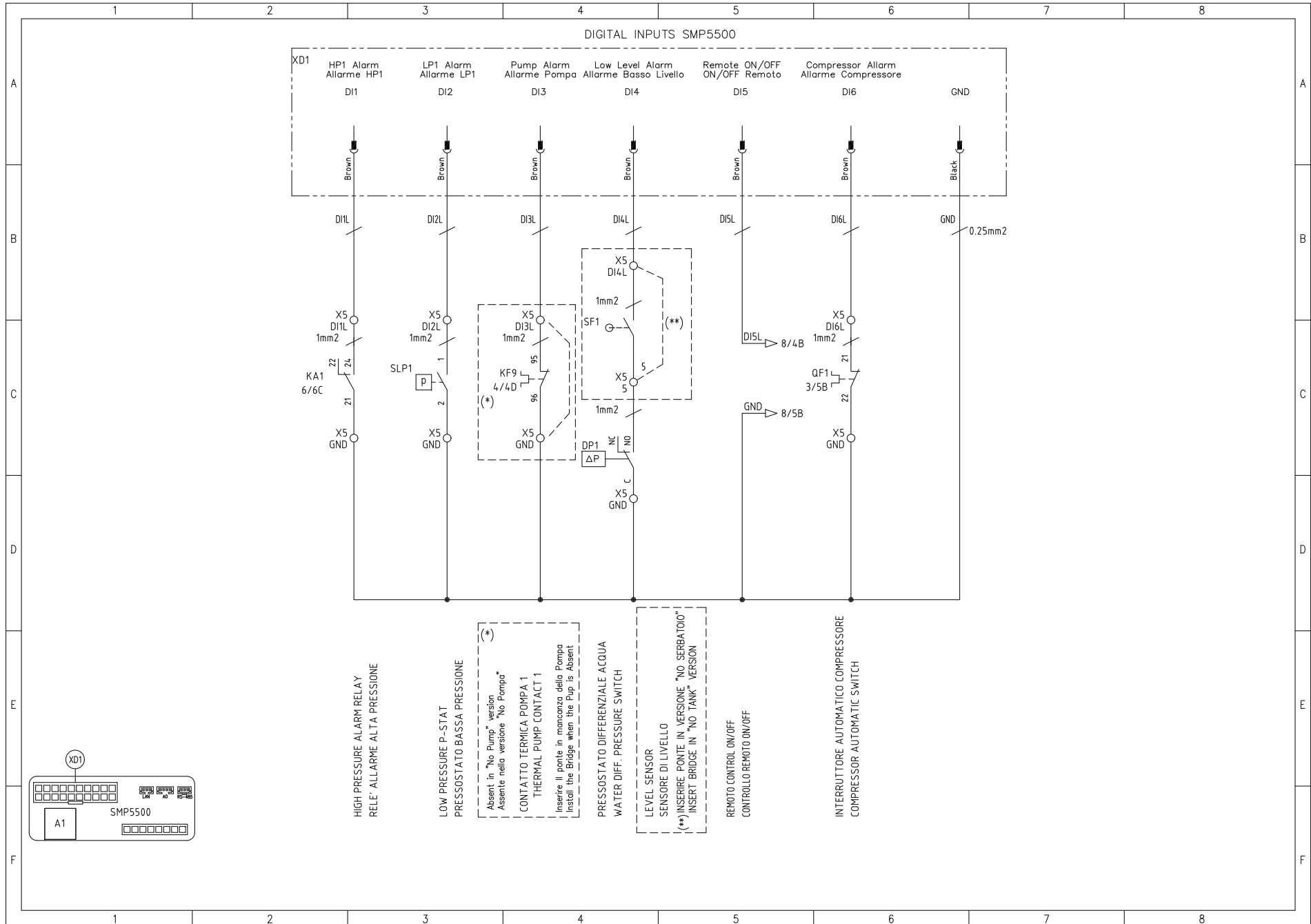

Wiring diagram ICEP022-027E (standard)

Sheet 9/11

OPTIONAL CONNECTIONS – COLLEGAMENTI OPZIONALI

Simple Remote Control – OPTION – Consult Parker
 OPZIONE – Controllo Remoto Semplice – Consultare Parker

A100

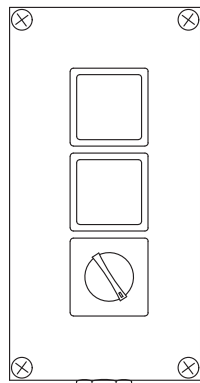

Terminal Blocks X8
 Morsettiere X8

ON SIGNAL LAMP
 LAMPADA SEGNALAZIONE ON

ALARM SIGNAL LAMP
 LAMPADA SEGNALAZIONE ALLARME

INTERRUPTORE ON/OFF
 ON/OFF INTERRUPTER

ADVANCE REMOTE Control – OPTION – Consult Parker
 OPZIONE – Controllo Remoto Avanzato – Consultare Parker

A103

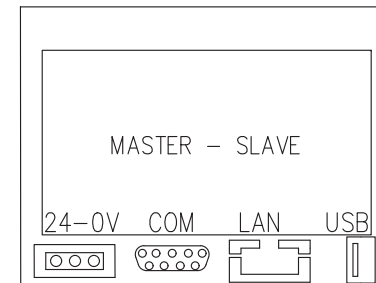

MASTER – SLAVE

MODBUS TCP-IP – OPTION – Consult Parker
 OPZIONE – MODBUS TCP-IP – Consultare Parker

A104

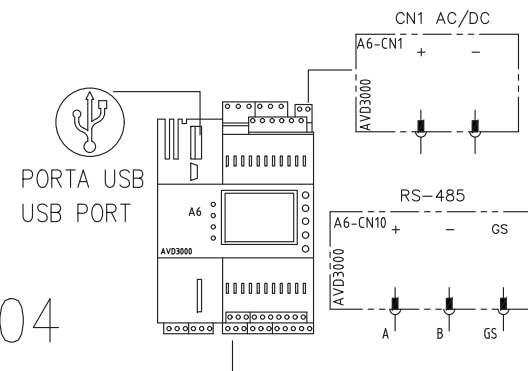

PORTA USB
 USB PORT

CN1 AC/DC

RS-485

Wiring diagram ICEP022-027E (standard)

Sheet 11/11

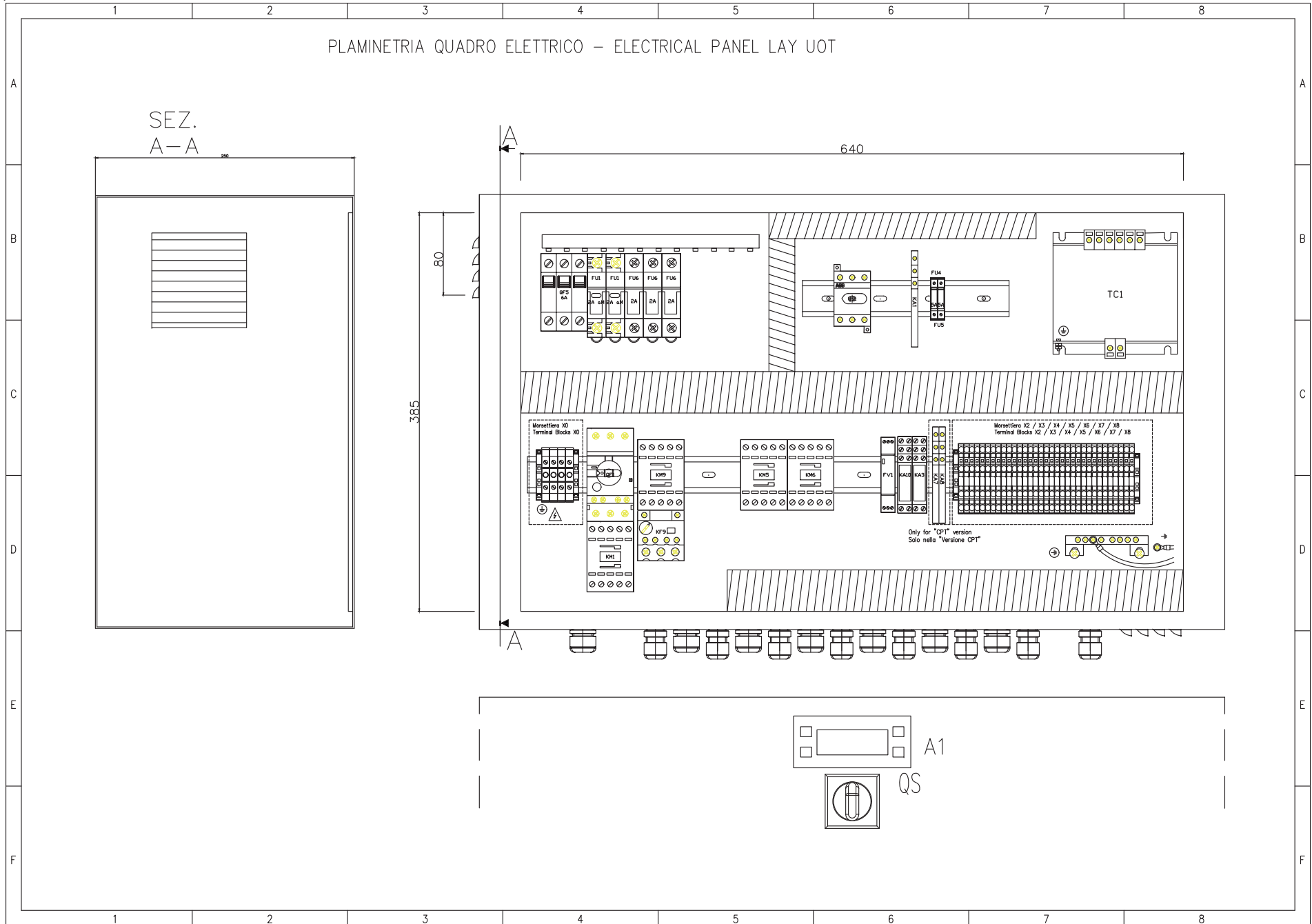

Wiring diagram ICEP008-015E (with option)

Sheet 1/15

MODEL MODELLO ICEP008-E	NOMINAL VOLTAGE TENSIONE NOMINALE Un (V) = 400				PHASES FASI Ph = 3				FREQUENCY FREQUENZA f (Hz) = 50				NOMINAL VOLTAGE TENSIONE NOMINALE Un (V) = 400				PHASES FASI Ph = 3				FREQUENCY FREQUENZA f (Hz) = 50				NOMINAL VOLTAGE TENSIONE NOMINALE Un (V) = 400V/3/50Hz			
	COMPRESSORS COMPRESSORI												FAN MOTOR ELETTROVENTILATORE				PUMP POMPA				MODEL - MODELLI ICEP008-E							
	SIGLA	FLA (A)	KW	LRA (A)	SIGLA	FLA (A)	KW	LRA (A)	SIGLA	FLA (A)	KW	LRA (A)	SIGLA	FLA (A)	MOP (A)	FLA (A) Tot.												
MC1	4.5	2.5	45	MF1	0.46	0.23	2.3	MP1 (P15)	1.4	λ	0.71	7.3	8	15	6.36													
								MP1 (P30)	1.65	λ	0.88	10.3	8	15	6.61													
								MP1 (P50)	3.3	λ	1.77	27.4	10	15	8.26													



MODEL MODELLO ICEP011-E	NOMINAL VOLTAGE TENSIONE NOMINALE Un (V) = 400				PHASES FASI Ph = 3				FREQUENCY FREQUENZA f (Hz) = 50				NOMINAL VOLTAGE TENSIONE NOMINALE Un (V) = 400				PHASES FASI Ph = 3				FREQUENCY FREQUENZA f (Hz) = 50				NOMINAL VOLTAGE TENSIONE NOMINALE Un (V) = 400V/3/50Hz			
	COMPRESSORS COMPRESSORI												FAN MOTOR ELETTROVENTILATORE				PUMP POMPA				MODEL - MODELLI ICEP011-E							
	SIGLA	FLA (A)	KW	LRA (A)	SIGLA	FLA (A)	KW	LRA (A)	SIGLA	FLA (A)	KW	LRA (A)	SIGLA	FLA (A)	MOP (A)	FLA (A) Tot.												
MC1	6.2	3.5	60	MF1	0.46	0.23	2.3	MP1 (P15)	1.4	λ	0.71	7.3	10	15	8.06													
								MP1 (P30)	1.65	λ	0.88	10.3	10	15	8.31													
								MP1 (P50)	3.3	λ	1.77	27.4	12	15	9.96													

MODEL MODELLO ICEP015-E	NOMINAL VOLTAGE TENSIONE NOMINALE Un (V) = 400				PHASES FASI Ph = 3				FREQUENCY FREQUENZA f (Hz) = 50				NOMINAL VOLTAGE TENSIONE NOMINALE Un (V) = 400				PHASES FASI Ph = 3				FREQUENCY FREQUENZA f (Hz) = 50				NOMINAL VOLTAGE TENSIONE NOMINALE Un (V) = 400V/3/50Hz			
	COMPRESSORS COMPRESSORI												FAN MOTOR ELETTROVENTILATORE				PUMP POMPA				MODEL - MODELLI ICEP015-E							
	SIGLA	FLA (A)	KW	LRA (A)	SIGLA	FLA (A)	KW	LRA (A)	SIGLA	FLA (A)	KW	LRA (A)	SIGLA	FLA (A)	MOP (A)	FLA (A) Tot.												
MC1	9.7	5.4	82	MF1	1.02	0.455	5.1	MP1 (P15)	1.4	λ	0.71	7.3	15	20	12.12													
								MP1 (P30)	1.78	λ	0.98	13.1	15	20	12.5													
								MP1 (P50)	3.3	λ	1.77	27.4	17	25	14.02													

FOLGIO/SHEET	DESCRIZIONE	DESCRIPTION
1	Dati Tecnici	Technical Data
2	Dati Tecnici	Technical Data
3	Circuito di Potenza	Power Circuit
4	Circuito di Potenza	Power Circuit
5	Circuito Ausiliario	Auxiliary Circuit
6	Circuito Ausiliario	Auxiliary Circuit
7	Circuito Ausiliario	Auxiliary Circuit
8	Modulo Espansione	Expansion Module
9	Modulo Espansione	Expansion Module
10	Modulo Espansione	Expansion Module
11	Contatti Cliente	Terminal Block for User
12	Collegamenti Opzionali	Optional Terminal Block
13	Collegamenti Opzionali	Optional Terminal Block
14	Morsettiera	Terminal Block
15	Planimetria Quadro Elettrico	Electrical Lay-Out
16	Lista Componenti	Component List
17	Lista Componenti	Component List
18	Lista Componenti	Component List
19	Lista Componenti	Component List
20	Lista Componenti Parker	Component List - Parker
21	Lista Componenti Parker	Component List - Parker

Wiring diagram ICEP008-015E (with option)

Sheet 2/15

	1	2	3	4	5	6	7	8																																																								
A	<table border="1"> <tr> <td>SUPPLY VOLTAGE TENSIONE ALIMENTAZIONE</td> <td>400V 3Ph 50Hz</td> </tr> <tr> <td>CONTROL VOLTAGE TENSIONE AUSILIARI</td> <td>0-24 VAC / 0-230 VAC</td> </tr> <tr> <td>ENCLOSED TYPE PROTEZIONE IP</td> <td>IP54</td> </tr> <tr> <td>RESIDUAL CURRENT SWITCH INTER. AUTOMATICO DIFFERENZIALE</td> <td>RCBO Id=0,03A CLASS A</td> </tr> <tr> <td>SCCR</td> <td>--</td> </tr> <tr> <td>GROUNDING MESSA A TERRA</td> <td>Solidly grounded</td> </tr> <tr> <td>CABLES SIZE SUPPLY CAVI INGRESSO ALIMENTAZIONE</td> <td>See Table (MCA)</td> </tr> </table>		SUPPLY VOLTAGE TENSIONE ALIMENTAZIONE	400V 3Ph 50Hz	CONTROL VOLTAGE TENSIONE AUSILIARI	0-24 VAC / 0-230 VAC	ENCLOSED TYPE PROTEZIONE IP	IP54	RESIDUAL CURRENT SWITCH INTER. AUTOMATICO DIFFERENZIALE	RCBO Id=0,03A CLASS A	SCCR	--	GROUNDING MESSA A TERRA	Solidly grounded	CABLES SIZE SUPPLY CAVI INGRESSO ALIMENTAZIONE	See Table (MCA)							A																																									
SUPPLY VOLTAGE TENSIONE ALIMENTAZIONE	400V 3Ph 50Hz																																																															
CONTROL VOLTAGE TENSIONE AUSILIARI	0-24 VAC / 0-230 VAC																																																															
ENCLOSED TYPE PROTEZIONE IP	IP54																																																															
RESIDUAL CURRENT SWITCH INTER. AUTOMATICO DIFFERENZIALE	RCBO Id=0,03A CLASS A																																																															
SCCR	--																																																															
GROUNDING MESSA A TERRA	Solidly grounded																																																															
CABLES SIZE SUPPLY CAVI INGRESSO ALIMENTAZIONE	See Table (MCA)																																																															
B									B																																																							
C									C																																																							
D	<table border="1"> <tr> <th colspan="3">Tightening Torque</th> </tr> <tr> <td colspan="3">  </td> </tr> <tr> <th>Component</th> <th>Nm</th> <th>Lb*In</th> </tr> <tr> <td>DILM9-10</td> <td>1,2000</td> <td>10,6000</td> </tr> <tr> <td>DILM15</td> <td>3.2000</td> <td>28.3000</td> </tr> <tr> <td>OT25F3</td> <td>0,8000</td> <td>7,0000</td> </tr> <tr> <td>BCH</td> <td>2,5000</td> <td>22,0000</td> </tr> <tr> <td>M4_8SFL</td> <td>0,8000</td> <td>7,0000</td> </tr> <tr> <td>FV1</td> <td>0,5000</td> <td>4,4000</td> </tr> <tr> <td>PKZM6.3 / 10</td> <td>1,7000</td> <td>15,0000</td> </tr> </table>			Tightening Torque						Component	Nm	Lb*In	DILM9-10	1,2000	10,6000	DILM15	3.2000	28.3000	OT25F3	0,8000	7,0000	BCH	2,5000	22,0000	M4_8SFL	0,8000	7,0000	FV1	0,5000	4,4000	PKZM6.3 / 10	1,7000	15,0000	<table border="1"> <tr> <th colspan="3">TABELLA COLORI CAVI - TABLE ELECTRICAL CABLES (Norme EN 60204-1)</th> </tr> <tr> <td>NERO - BLACK</td> <td>BK</td> <td>Conduttore di Potenza Principale in AC/DC - Main Power Circuits AC and DC</td> </tr> <tr> <td>AZZURRO - LIGHT BLUE</td> <td>BU</td> <td>Conduttore di Neutro - Neutral Conductor</td> </tr> <tr> <td>ROSSO - RED</td> <td>RD</td> <td>Circuiti di Comando in Corrente Alternata AC 12-24-230VAC - Control Circuits in AC 12-24-230VAC</td> </tr> <tr> <td>BLU SCURO - DARK BLUE</td> <td>DBU</td> <td>Circuiti di Comando in Corrente Continua DC 24VDC - Control Circuits in DC 24VDC</td> </tr> <tr> <td>ARANCIONE - ORANGE</td> <td>OG</td> <td>Circuiti Segnali in Tensione - Voltage Signal Circuits</td> </tr> <tr> <td>BIANCO - WHITE</td> <td>WH</td> <td>Circuiti di Misura - Measuring Circuits</td> </tr> <tr> <td>GIALLO-VERDE</td> <td>GNYE</td> <td>Conduttore di Terra - Grounded Conductors</td> </tr> </table>			TABELLA COLORI CAVI - TABLE ELECTRICAL CABLES (Norme EN 60204-1)			NERO - BLACK	BK	Conduttore di Potenza Principale in AC/DC - Main Power Circuits AC and DC	AZZURRO - LIGHT BLUE	BU	Conduttore di Neutro - Neutral Conductor	ROSSO - RED	RD	Circuiti di Comando in Corrente Alternata AC 12-24-230VAC - Control Circuits in AC 12-24-230VAC	BLU SCURO - DARK BLUE	DBU	Circuiti di Comando in Corrente Continua DC 24VDC - Control Circuits in DC 24VDC	ARANCIONE - ORANGE	OG	Circuiti Segnali in Tensione - Voltage Signal Circuits	BIANCO - WHITE	WH	Circuiti di Misura - Measuring Circuits	GIALLO-VERDE	GNYE	Conduttore di Terra - Grounded Conductors				D
Tightening Torque																																																																
																																																																
Component	Nm	Lb*In																																																														
DILM9-10	1,2000	10,6000																																																														
DILM15	3.2000	28.3000																																																														
OT25F3	0,8000	7,0000																																																														
BCH	2,5000	22,0000																																																														
M4_8SFL	0,8000	7,0000																																																														
FV1	0,5000	4,4000																																																														
PKZM6.3 / 10	1,7000	15,0000																																																														
TABELLA COLORI CAVI - TABLE ELECTRICAL CABLES (Norme EN 60204-1)																																																																
NERO - BLACK	BK	Conduttore di Potenza Principale in AC/DC - Main Power Circuits AC and DC																																																														
AZZURRO - LIGHT BLUE	BU	Conduttore di Neutro - Neutral Conductor																																																														
ROSSO - RED	RD	Circuiti di Comando in Corrente Alternata AC 12-24-230VAC - Control Circuits in AC 12-24-230VAC																																																														
BLU SCURO - DARK BLUE	DBU	Circuiti di Comando in Corrente Continua DC 24VDC - Control Circuits in DC 24VDC																																																														
ARANCIONE - ORANGE	OG	Circuiti Segnali in Tensione - Voltage Signal Circuits																																																														
BIANCO - WHITE	WH	Circuiti di Misura - Measuring Circuits																																																														
GIALLO-VERDE	GNYE	Conduttore di Terra - Grounded Conductors																																																														
E									E																																																							
F									F																																																							
	1	2	3	4	5	6	7	8																																																								

Wiring diagram ICEP008-015E (with option)

Sheet 3/15

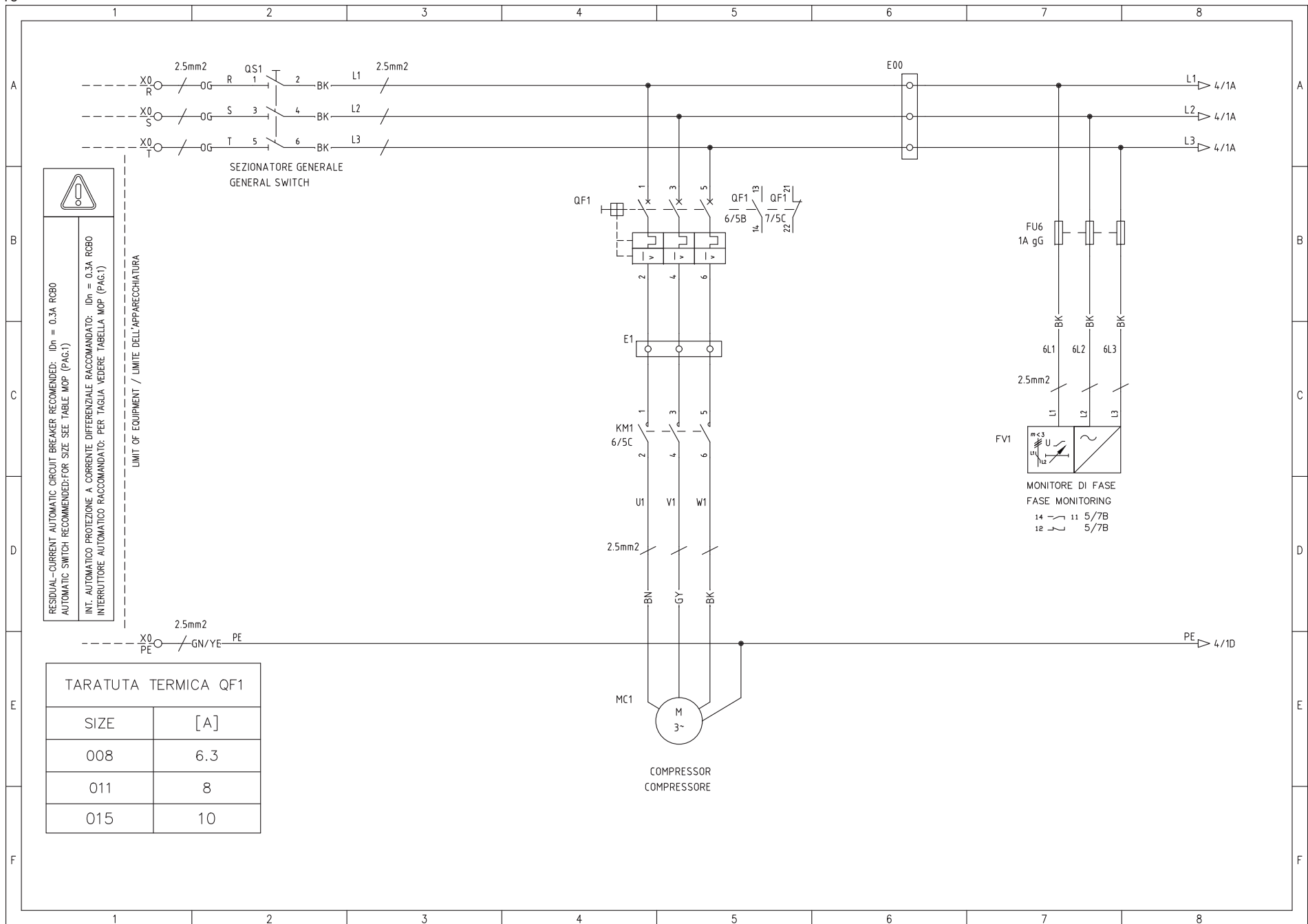

Wiring diagram ICEP008-015E (with option)

Sheet 4/15

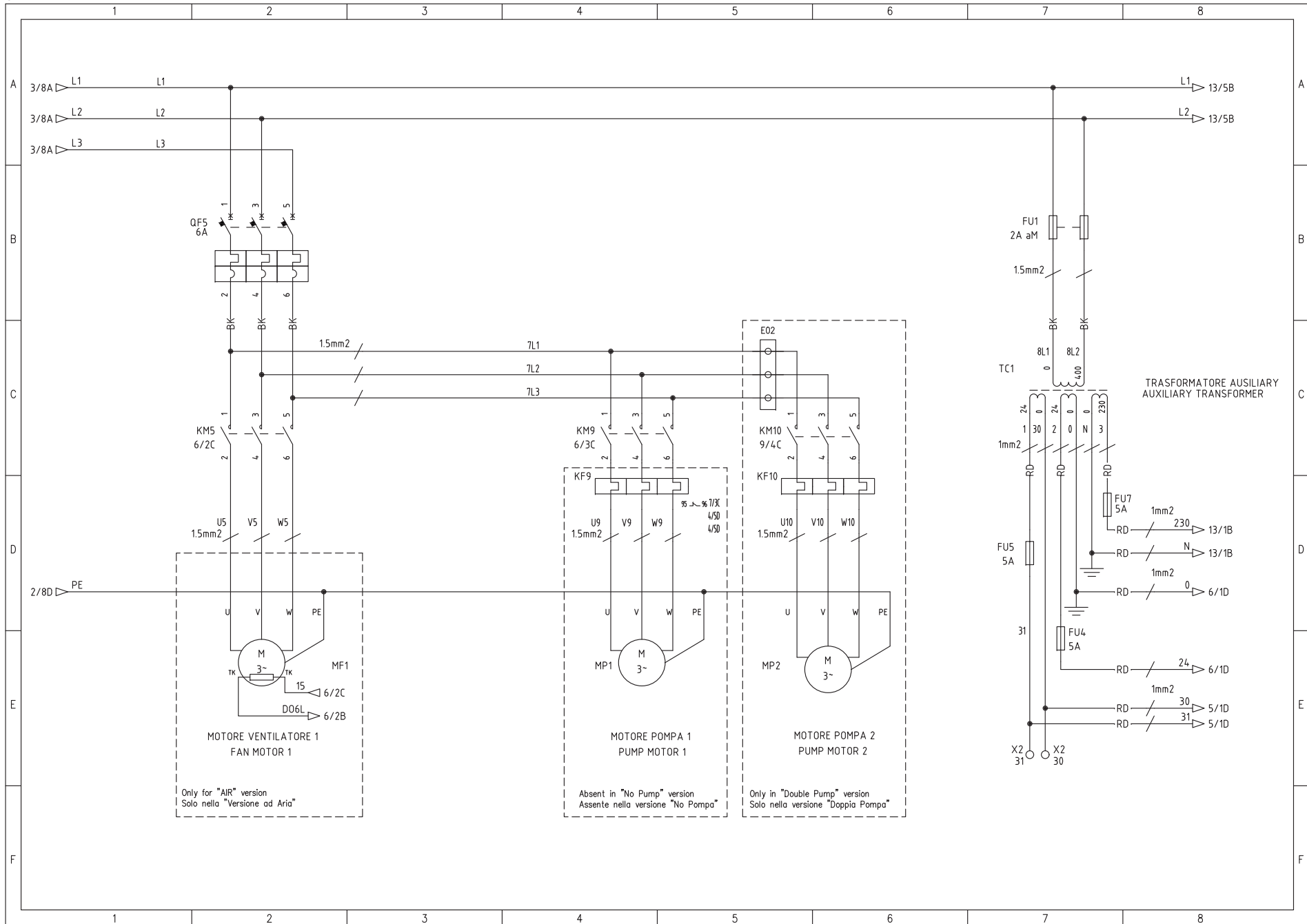

Wiring diagram ICEP008-015E (with option)

Sheet 5/15

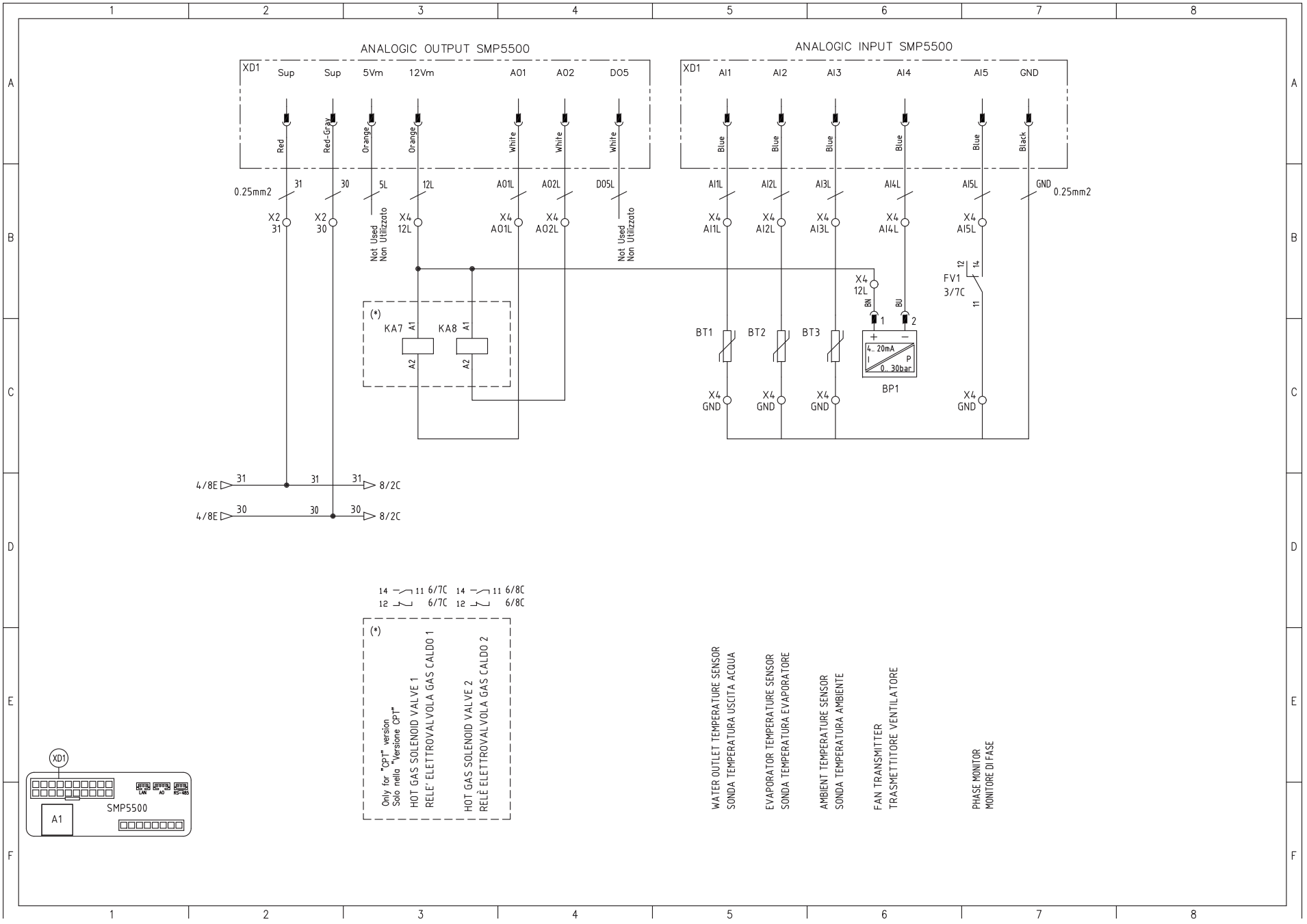

Wiring diagram ICEP008-015E (with option)

Sheet 6/15

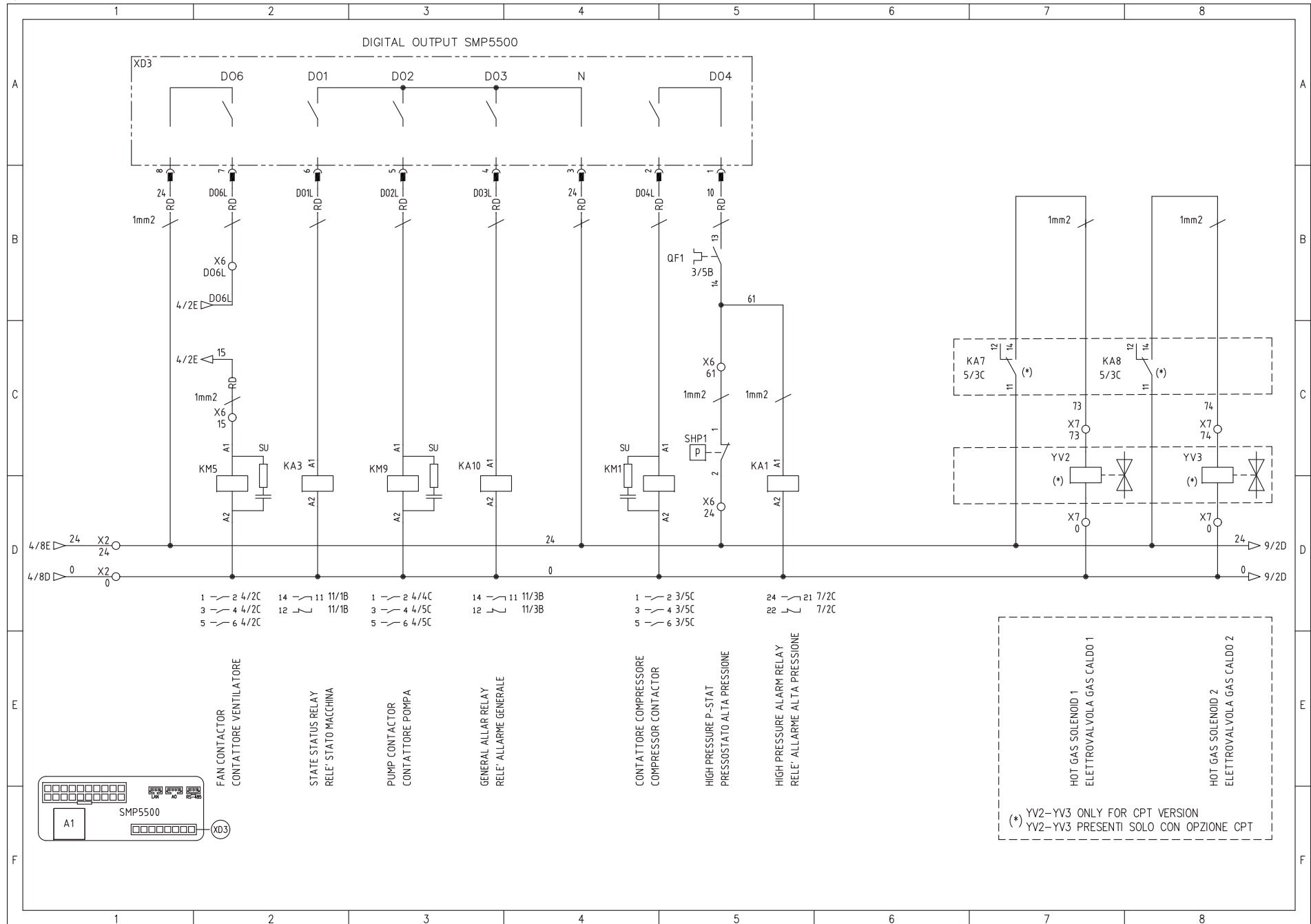

Wiring diagram ICEP008-015E (with option)

Sheet 7/15

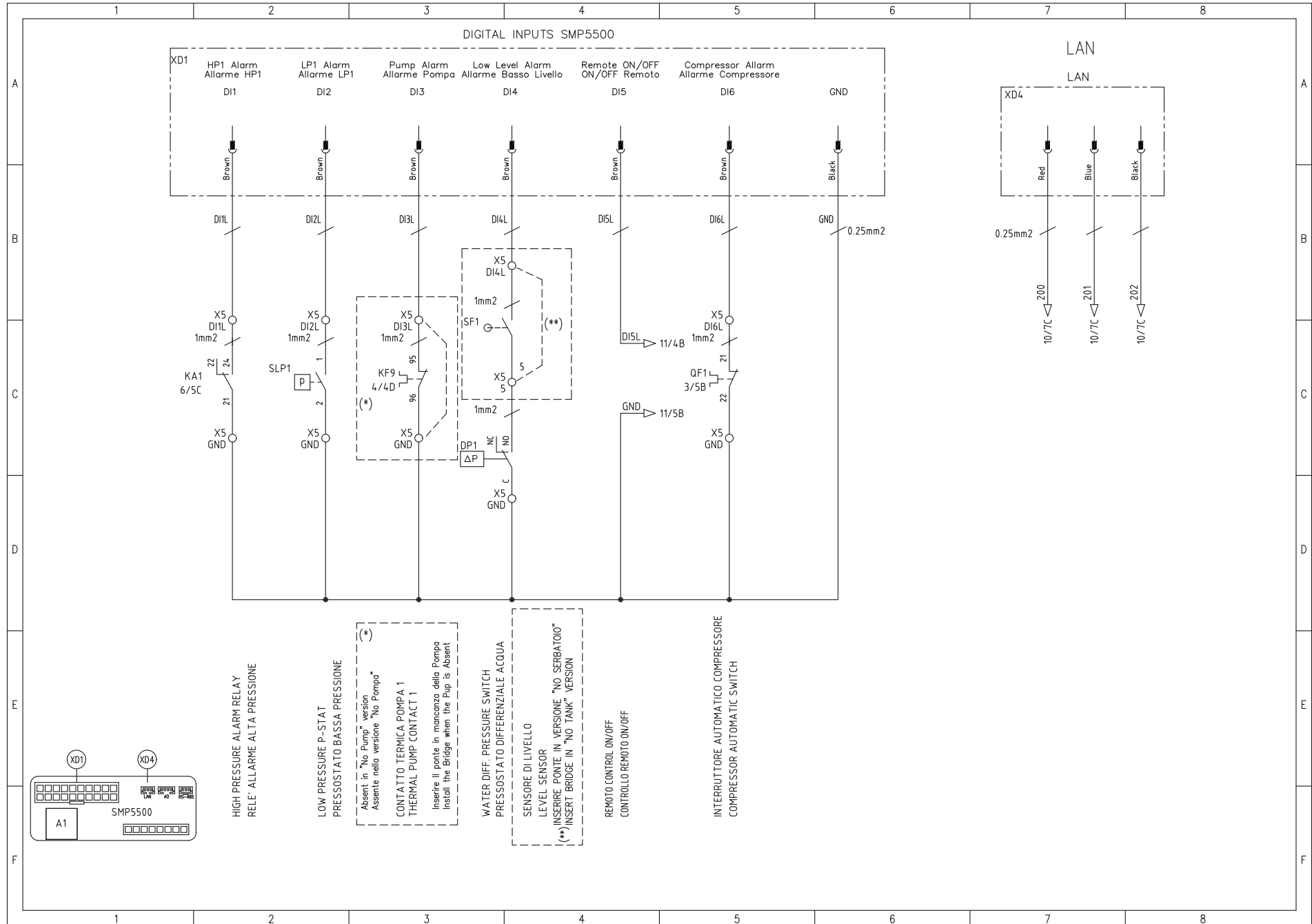

Wiring diagram ICEP008-015E (with option)

Sheet 8/15

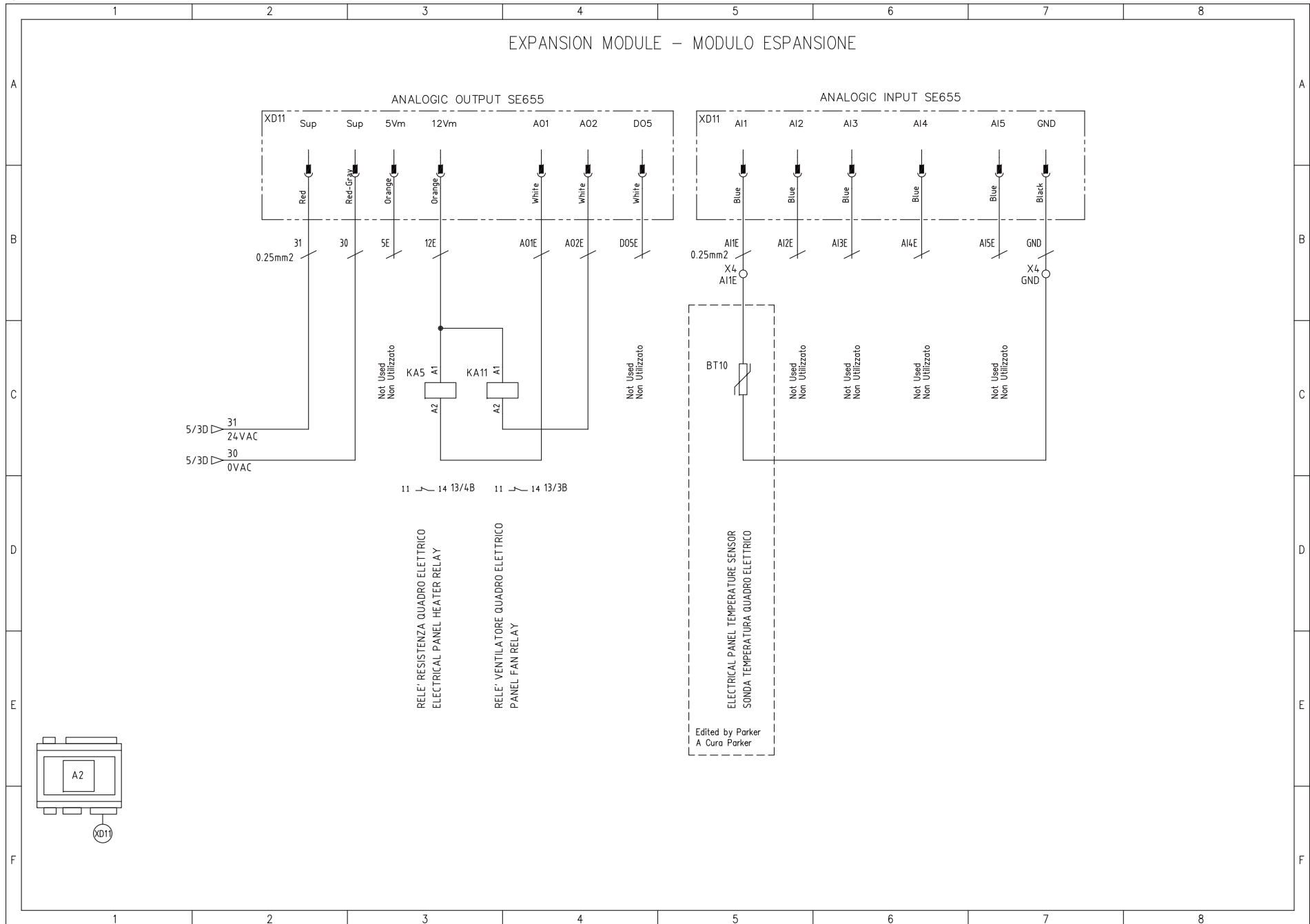

Wiring diagram ICEP008-015E (with option)

Sheet 9/15

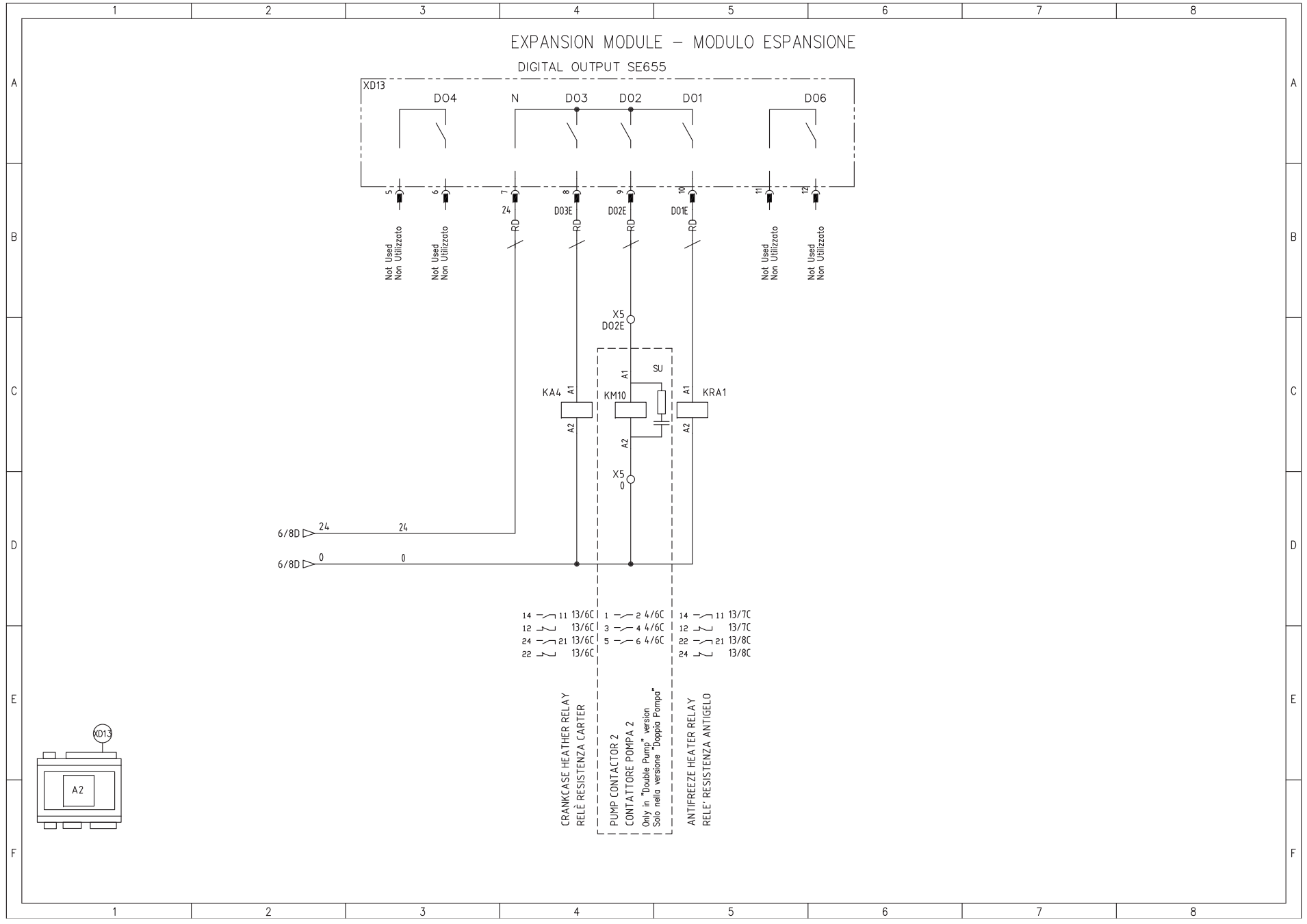

Wiring diagram ICEP008-015E (with option)

Sheet 10/15

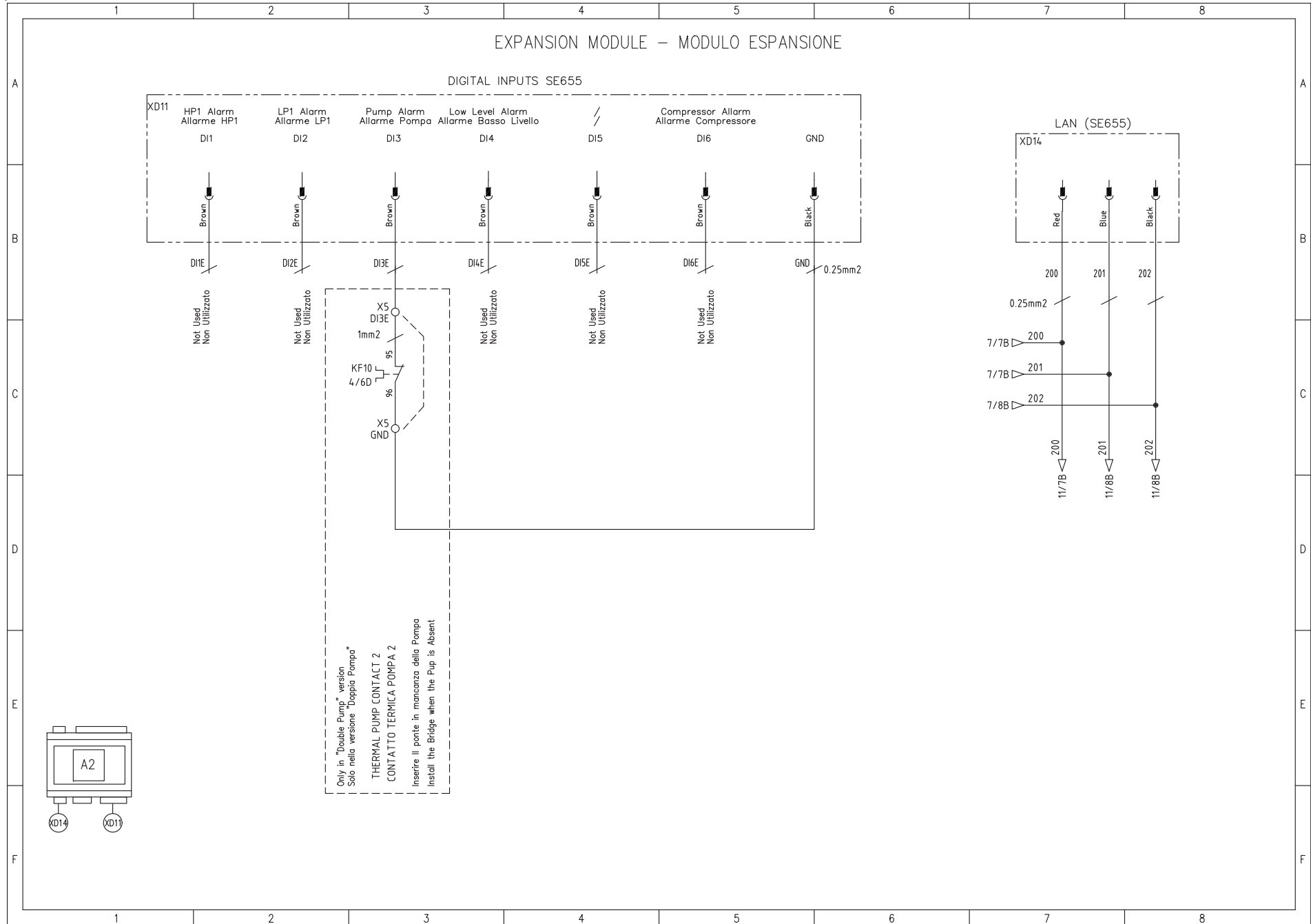

Wiring diagram ICEP008-015E (with option)

Sheet 11/15

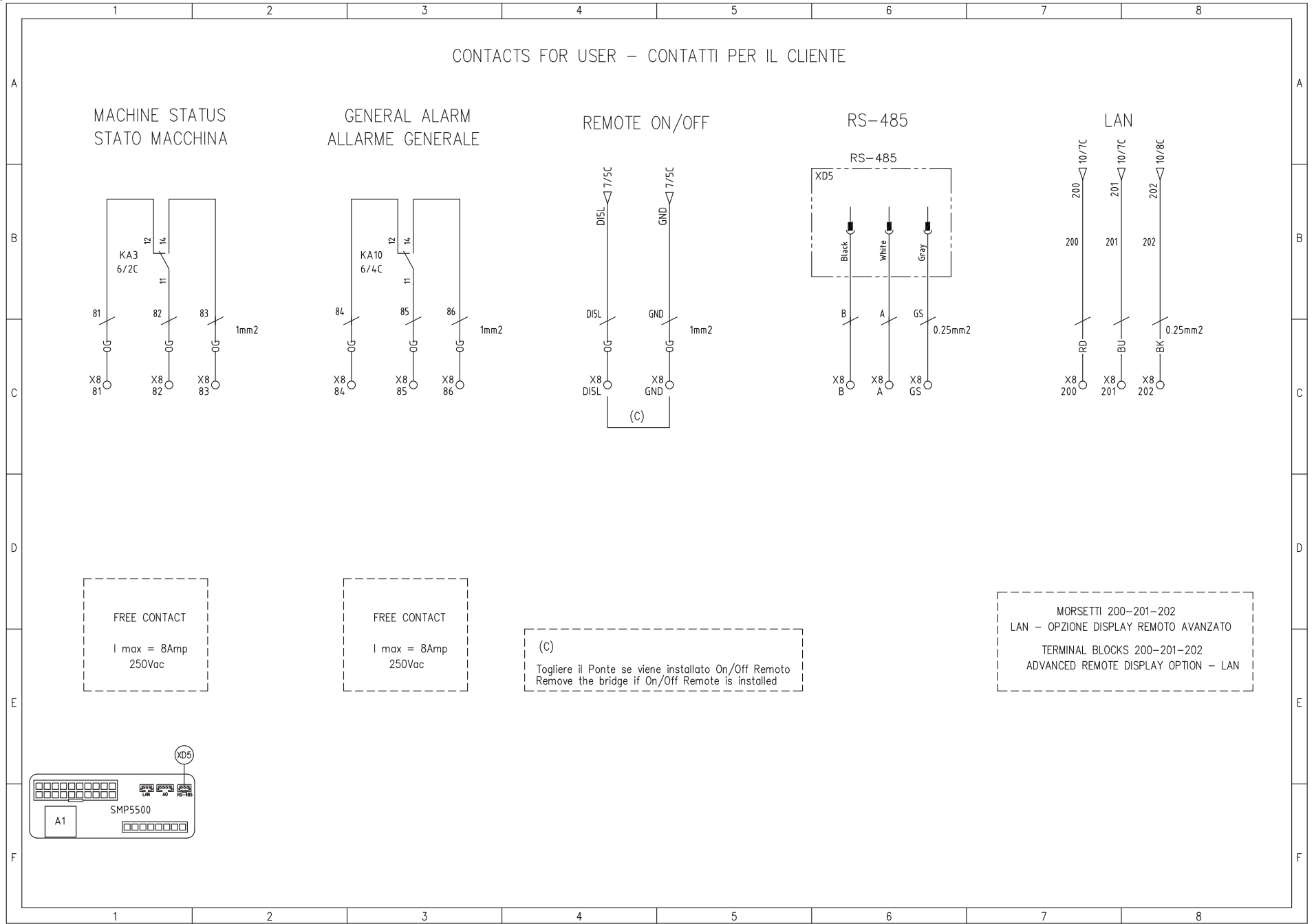

Wiring diagram ICEP008-015E (with option)

Sheet 12/15

OPTIONAL CONNECTIONS – COLLEGAMENTI OPZIONALI

Simple Remote Control – OPTION – Consult Parker
 OPZIONE – Controllo Remoto Semplice – Consultare Parker

A100

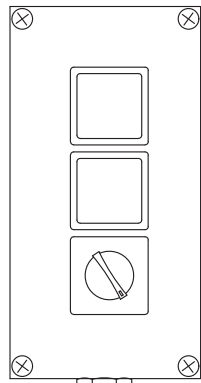

Terminal Blocks XB
 Morsettiere XB

ON SIGNAL LAMP
 LAMPADA SEGNALAZIONE ON

ALARM SIGNAL LAMP
 LAMPADA SEGNALAZIONE ALLARME

INTERRUPTORE ON/OFF
 ON/OFF INTERRUPTER

ADVANCE REMOTE Control – OPTION – Consult Parker
 OPZIONE – Controllo Remoto Avanzato – Consultare Parker

A103

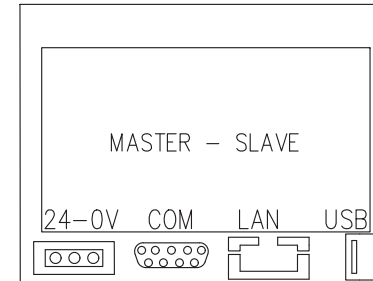

MASTER – SLAVE

MODBUS TCP-IP – OPTION – Consult Parker
 OPZIONE – MODBUS TCP-IP – Consultare Parker

A104

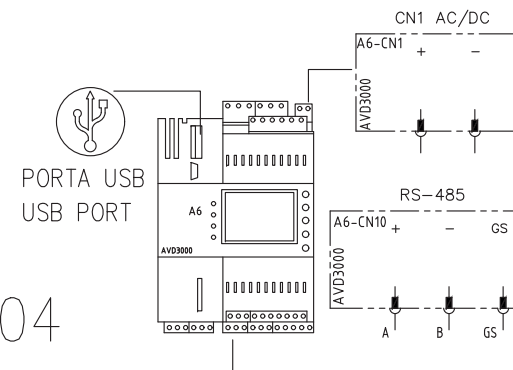

PORTA USB
 USB PORT

Wiring diagram ICEP008-015E (with option)

Sheet 13/15

OPTION TERMINAL BLOCKS – MORSETTI COLLEGAMENTI OPZIONI

Electrical Panel Heater/Fan
Resistenza Quadro Elettrico/Ventilazione

Crankcase Heater Compressor
Resistenza Carter compressore

Antifreeze Heater
Resistenza Antigelo

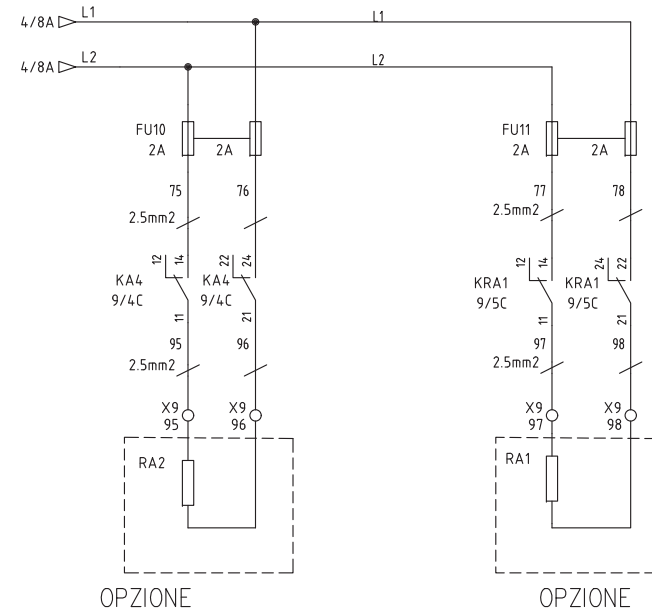
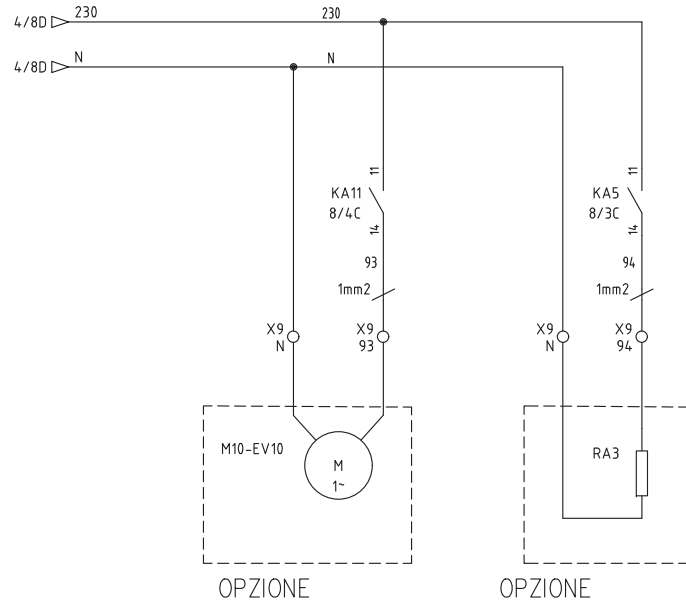

ELECTRICAL PANEL FAN MOTOR
MOTORE VENTILATORE QUADRO ELETTRICO

ELECTRICAL PANEL HEATER
RESISTENZA QUADRO ELETTRICO

CRANKCASE HEATER
RESISTENZA CARTER

ANTIFREEZE HEATER
RESISTENZA ANTIFREEZE

Wiring diagram ICEP008-015E (with option)

Sheet 15/15

PLAMINETRIA QUADRO ELETTRICO – ELECTRICAL PANEL LAYOUT

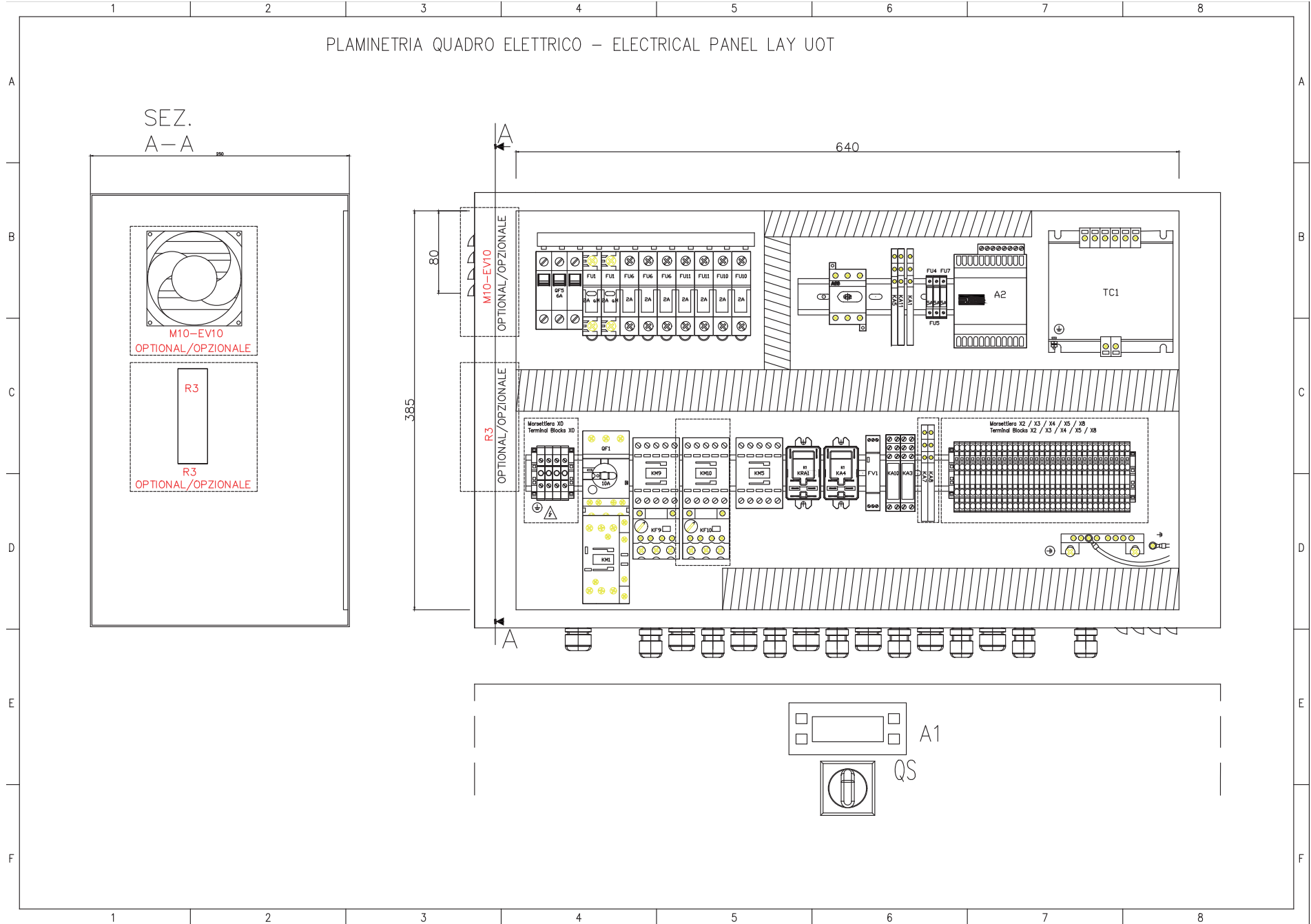

Wiring diagram ICEP022-027E (with option)

Sheet 1/15

MODELLO MODELLO ICEP022-E	NOMINAL VOLTAGE TENSIONE NOMINALE Un (V) = 400				PHASES FASI Ph = 3				FREQUENCY FREQUENZA f (Hz) = 50				NOMINAL VOLTAGE TENSIONE NOMINALE Un (V) = 400				PHASES FASI Ph = 3				FREQUENCY FREQUENZA f (Hz) = 50				NOMINAL VOLTAGE TENSIONE NOMINALE Un (V) = 400V/3/50Hz			
	COMPRESSORS COMPRESSORI												FAN MOTOR ELETTOVENTILATORE								PUMP POMPA				MODEL - MODELLI ICEP022-E			
	SIGLA	FLA (A)	KW	LRA (A)	SIGLA	FLA (A)	KW	LRA (A)	SIGLA	FLA (A)	KW	LRA (A)	SIGLA	FLA (A)	MOP (A)	FLA (A) Tot.												
MC1	11.8	6.5	95	MF1	1,02 λ	0,455	5.1	MP1 (P15)	1.4	0.71	7.3	19	25	15.24														
				MF2	1,02 λ	0,455	5.1	MP1 (P30)	2.37	1.28	19.7	20	30	16.21														
								MP1 (P50)	3.3	1.77	27.4	21	30	17.14														

MODELLO MODELLO ICEP027-E	NOMINAL VOLTAGE TENSIONE NOMINALE Un (V) = 400				PHASES FASI Ph = 3				FREQUENCY FREQUENZA f (Hz) = 50				NOMINAL VOLTAGE TENSIONE NOMINALE Un (V) = 400				PHASES FASI Ph = 3				FREQUENCY FREQUENZA f (Hz) = 50				NOMINAL VOLTAGE TENSIONE NOMINALE Un (V) = 400V/3/50Hz			
	COMPRESSORS COMPRESSORI												FAN MOTOR ELETTOVENTILATORE								PUMP POMPA				MODEL - MODELLI ICEP027-E			
	SIGLA	FLA (A)	KW	LRA (A)	SIGLA	FLA (A)	KW	LRA (A)	SIGLA	FLA (A)	KW	LRA (A)	SIGLA	FLA (A)	MOP (A)	FLA (A) Tot.												
MC1	18.3	8.7	140	MF1	1,02 λ	0,455	5.1	MP1 (P15)	1.7	0.91	11.8	27	40	22.04														
				MF2	1,02 λ	0,455	5.1	MP1 (P30)	2.37	1.28	19.7	28	45	22.71														
								MP1 (P50)	4.7	2.55	38.4	30	45	25.04														

FOLGIO/SHEET	DESCRIZIONE	DESCRIPTION
1	Dati Tecnici	Technical Data
2	Dati Tecnici	Technical Data
3	Circuito di Potenza	Power Circuit
4	Circuito di Potenza	Power Circuit
5	Circuito Ausiliario	Auxiliary Circuit
6	Circuito Ausiliario	Auxiliary Circuit
7	Circuito Ausiliario	Auxiliary Circuit
8	Modulo Espansione	Expansion Module
9	Modulo Espansione	Expansion Module
10	Modulo Espansione	Expansion Module
11	Contatti Cliente	Terminal Block for User
12	Collegamenti Opzionali	Optional Terminal Block
13	Collegamenti Opzionali	Optional Terminal Block
14	Marsettiera	Terminal Block
15	Planimetria Quadro Elettrico	Electrical Lay-Out
16	Lista Componenti	Component List
17	Lista Componenti	Component List
18	Lista Componenti	Component List
19	Lista Componenti	Component List
20	Lista Componenti Parker	Component List - Parker
21	Lista Componenti Parker	Component List - Parker

Wiring diagram ICEP022-027E (with option)

Sheet 2/15

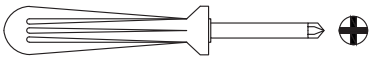
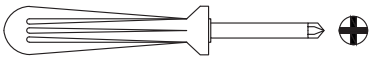
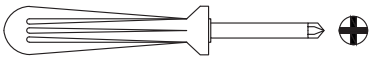
	1	2	3	4	5	6	7	8																																																						
A			<table border="1"> <tr> <td>SUPPLY VOLTAGE TENSIONE ALIMENTAZIONE</td> <td>400V 3Ph 50Hz</td> </tr> <tr> <td>CONTROL VOLTAGE TENSIONE AUSILIARI</td> <td>0-24 VAC / 0-230 VAC</td> </tr> <tr> <td>ENCLOSED TYPE PROTEZIONE IP</td> <td>IP54</td> </tr> <tr> <td>RESIDUAL CURRENT SWITCH INTER. AUTOMATICO DIFFERENZIALE</td> <td>RCBO Id=0,03A CLASS A</td> </tr> <tr> <td>SCCR</td> <td>--</td> </tr> <tr> <td>GROUNDING MESSA A TERRA</td> <td>Solidly grounded</td> </tr> <tr> <td>CABLES SIZE SUPPLY CAVI INGRESSO ALIMENTAZIONE</td> <td>See Table (MCA)</td> </tr> </table>		SUPPLY VOLTAGE TENSIONE ALIMENTAZIONE	400V 3Ph 50Hz	CONTROL VOLTAGE TENSIONE AUSILIARI	0-24 VAC / 0-230 VAC	ENCLOSED TYPE PROTEZIONE IP	IP54	RESIDUAL CURRENT SWITCH INTER. AUTOMATICO DIFFERENZIALE	RCBO Id=0,03A CLASS A	SCCR	--	GROUNDING MESSA A TERRA	Solidly grounded	CABLES SIZE SUPPLY CAVI INGRESSO ALIMENTAZIONE	See Table (MCA)																																												
SUPPLY VOLTAGE TENSIONE ALIMENTAZIONE	400V 3Ph 50Hz																																																													
CONTROL VOLTAGE TENSIONE AUSILIARI	0-24 VAC / 0-230 VAC																																																													
ENCLOSED TYPE PROTEZIONE IP	IP54																																																													
RESIDUAL CURRENT SWITCH INTER. AUTOMATICO DIFFERENZIALE	RCBO Id=0,03A CLASS A																																																													
SCCR	--																																																													
GROUNDING MESSA A TERRA	Solidly grounded																																																													
CABLES SIZE SUPPLY CAVI INGRESSO ALIMENTAZIONE	See Table (MCA)																																																													
B																																																														
C																																																														
D	<table border="1"> <tr> <th colspan="3">Tightening Torque</th> </tr> <tr> <td colspan="3" style="text-align: center;">  </td> </tr> <tr> <th>Component</th> <th>Nm</th> <th>Lb*In</th> </tr> <tr> <td>DILM9-10</td> <td>1,2000</td> <td>10,6000</td> </tr> <tr> <td>DILM15/25</td> <td>1,2000</td> <td>10,6000</td> </tr> <tr> <td>OT063F3</td> <td>0,8000</td> <td>7</td> </tr> <tr> <td>BCH</td> <td>2,5000</td> <td>22,0000</td> </tr> <tr> <td>M4_8SFL</td> <td>0,8000</td> <td>7,0000</td> </tr> <tr> <td>FV1</td> <td>0,5000</td> <td>4,4000</td> </tr> <tr> <td>PKZM16 / 20</td> <td>1,7000</td> <td>15,0000</td> </tr> </table>		Tightening Torque						Component	Nm	Lb*In	DILM9-10	1,2000	10,6000	DILM15/25	1,2000	10,6000	OT063F3	0,8000	7	BCH	2,5000	22,0000	M4_8SFL	0,8000	7,0000	FV1	0,5000	4,4000	PKZM16 / 20	1,7000	15,0000	<table border="1"> <tr> <th colspan="3">TABELLA COLORI CAVI - TABLE ELECTRICAL CABLES (Norme EN 60204-1)</th> </tr> <tr> <td>NERO - BLACK</td> <td>BK</td> <td>Conduttore di Potenza Principale in AC/DC - Main Power Circuits AC and DC</td> </tr> <tr> <td>AZZURRO - LIGHT BLUE</td> <td>BU</td> <td>Conduttore di Neutro - Neutral Conductor</td> </tr> <tr> <td>ROSSO - RED</td> <td>RD</td> <td>Circuiti di Comando in Corrente Alternata AC 12-24-230VAC - Control Circuits in AC 12-24-230VAC</td> </tr> <tr> <td>BLU SCURO - DARK BLUE</td> <td>DBU</td> <td>Circuiti di Comando in Corrente Continua DC 24VDC - Control Circuits in DC 24VDC</td> </tr> <tr> <td>ARANCIONE - ORANGE</td> <td>OG</td> <td>Circuiti Segnali in Tensione - Voltage Signal Circuits</td> </tr> <tr> <td>BIANCO - WHITE</td> <td>WH</td> <td>Circuiti di Misura - Measuring Circuits</td> </tr> <tr> <td>GIALLO-VERDE</td> <td>GNYE</td> <td>Conduttore di Terra - Grounded Conductors</td> </tr> </table>		TABELLA COLORI CAVI - TABLE ELECTRICAL CABLES (Norme EN 60204-1)			NERO - BLACK	BK	Conduttore di Potenza Principale in AC/DC - Main Power Circuits AC and DC	AZZURRO - LIGHT BLUE	BU	Conduttore di Neutro - Neutral Conductor	ROSSO - RED	RD	Circuiti di Comando in Corrente Alternata AC 12-24-230VAC - Control Circuits in AC 12-24-230VAC	BLU SCURO - DARK BLUE	DBU	Circuiti di Comando in Corrente Continua DC 24VDC - Control Circuits in DC 24VDC	ARANCIONE - ORANGE	OG	Circuiti Segnali in Tensione - Voltage Signal Circuits	BIANCO - WHITE	WH	Circuiti di Misura - Measuring Circuits	GIALLO-VERDE	GNYE	Conduttore di Terra - Grounded Conductors				
Tightening Torque																																																														
																																																														
Component	Nm	Lb*In																																																												
DILM9-10	1,2000	10,6000																																																												
DILM15/25	1,2000	10,6000																																																												
OT063F3	0,8000	7																																																												
BCH	2,5000	22,0000																																																												
M4_8SFL	0,8000	7,0000																																																												
FV1	0,5000	4,4000																																																												
PKZM16 / 20	1,7000	15,0000																																																												
TABELLA COLORI CAVI - TABLE ELECTRICAL CABLES (Norme EN 60204-1)																																																														
NERO - BLACK	BK	Conduttore di Potenza Principale in AC/DC - Main Power Circuits AC and DC																																																												
AZZURRO - LIGHT BLUE	BU	Conduttore di Neutro - Neutral Conductor																																																												
ROSSO - RED	RD	Circuiti di Comando in Corrente Alternata AC 12-24-230VAC - Control Circuits in AC 12-24-230VAC																																																												
BLU SCURO - DARK BLUE	DBU	Circuiti di Comando in Corrente Continua DC 24VDC - Control Circuits in DC 24VDC																																																												
ARANCIONE - ORANGE	OG	Circuiti Segnali in Tensione - Voltage Signal Circuits																																																												
BIANCO - WHITE	WH	Circuiti di Misura - Measuring Circuits																																																												
GIALLO-VERDE	GNYE	Conduttore di Terra - Grounded Conductors																																																												
E																																																														
F																																																														
	1	2	3	4	5	6	7	8																																																						

Wiring diagram ICEP022-027E (with option)

Sheet 3/15

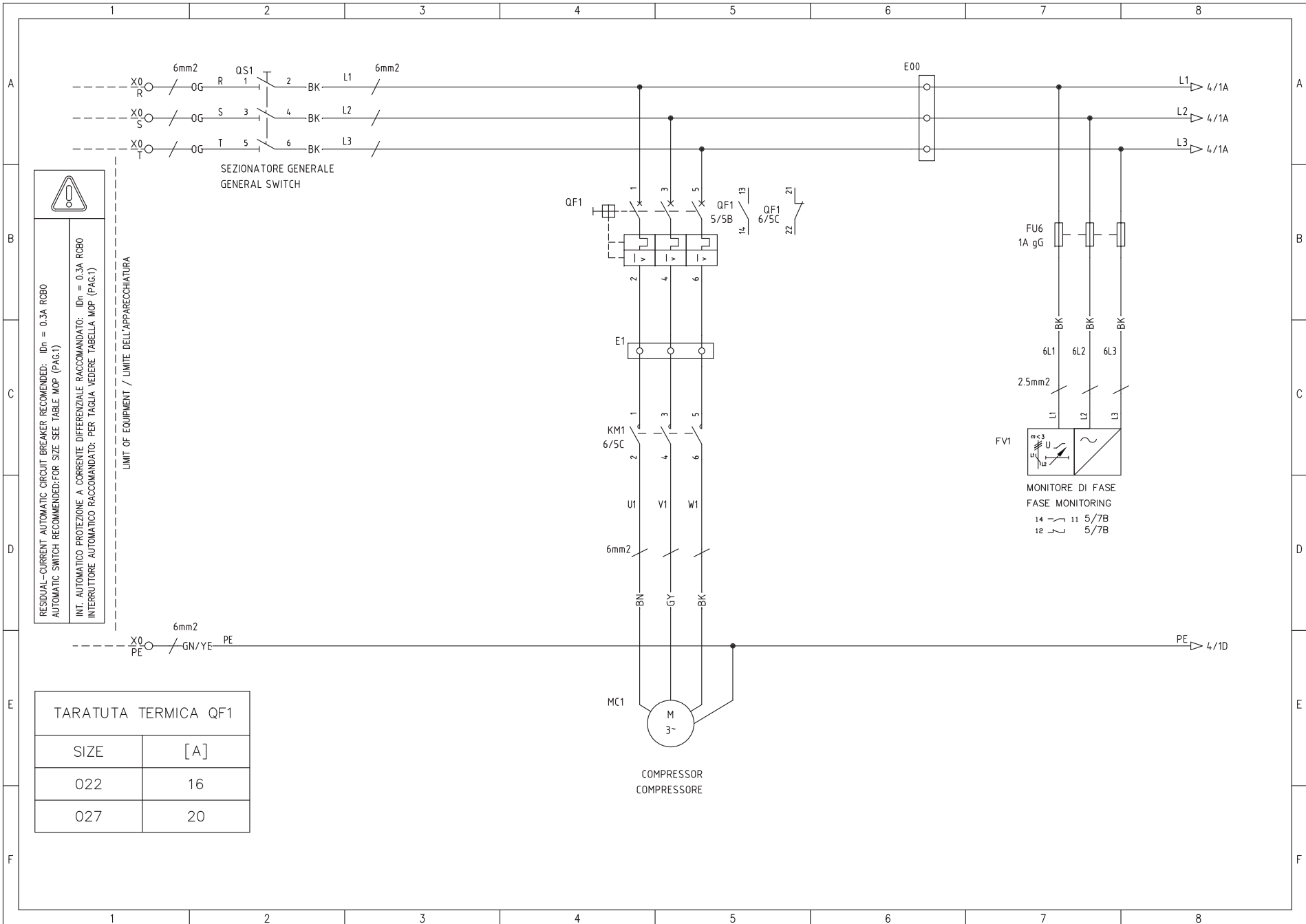

RESIDUAL-CURRENT AUTOMATIC CIRCUIT BREAKER RECOMMENDED: I_{dn} = 0.3A RCBO
 AUTOMATIC SWITCH RECOMMENDED: FOR SIZE SEE TABLE MOP (PAG.1)
 INT. AUTOMATICO PROIEZIONE A CORRENTE DIFFERENZIALE RACCOMANDATO: I_{dn} = 0.3A RCBO
 INTERRUTTORE AUTOMATICO RACCOMANDATO: PER TAGLIA VEDERE TABELLA MOP (PAG.1)

LIMIT OF EQUIPMENT / LIMITE DELL'APPARECCHIATURA

TARATURA TERMICA QF1	
SIZE	[A]
022	16
027	20

Wiring diagram ICEP022-027E (with option)

Sheet 4/15

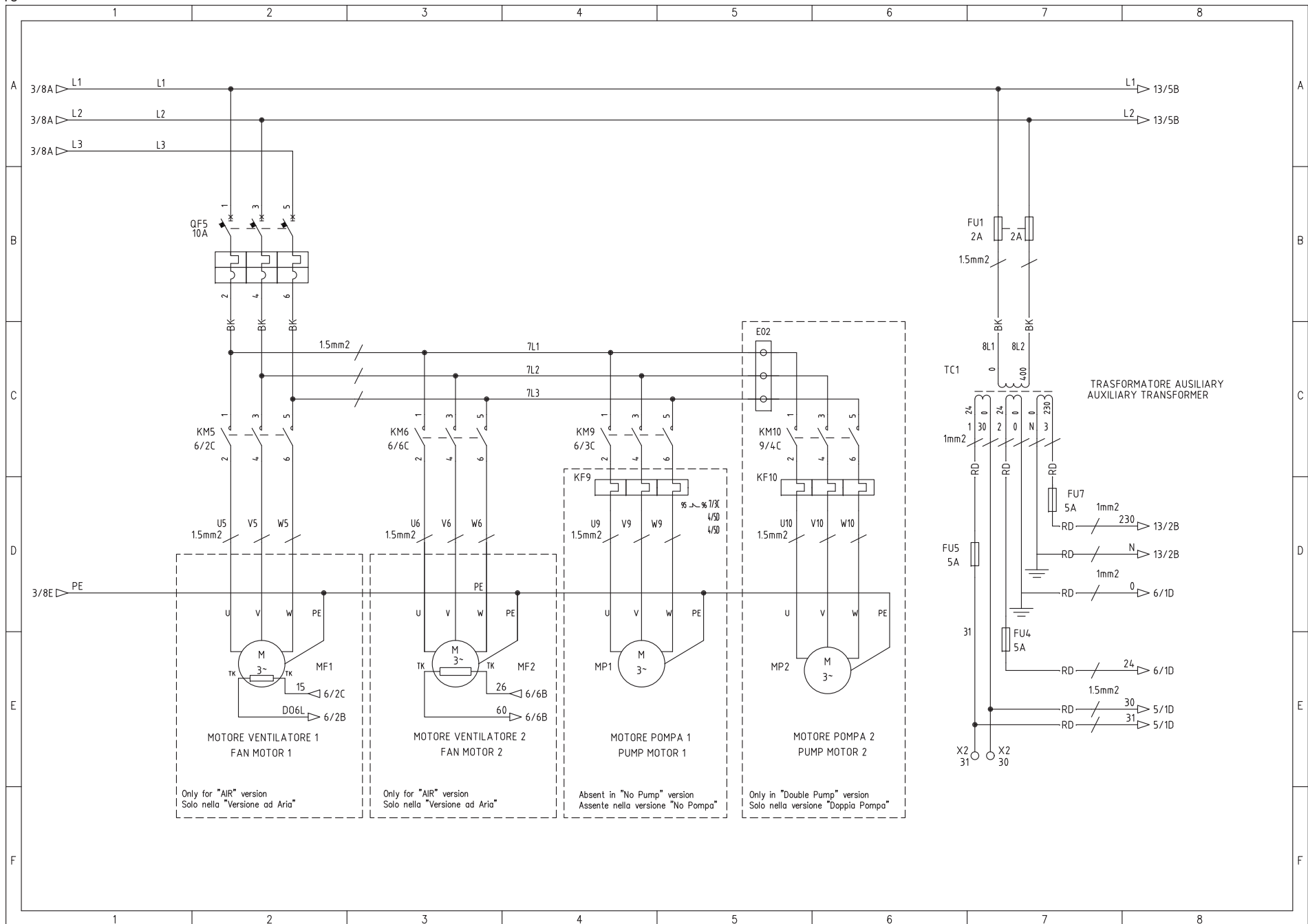

Wiring diagram ICEP022-027E (with option)

Sheet 5/15

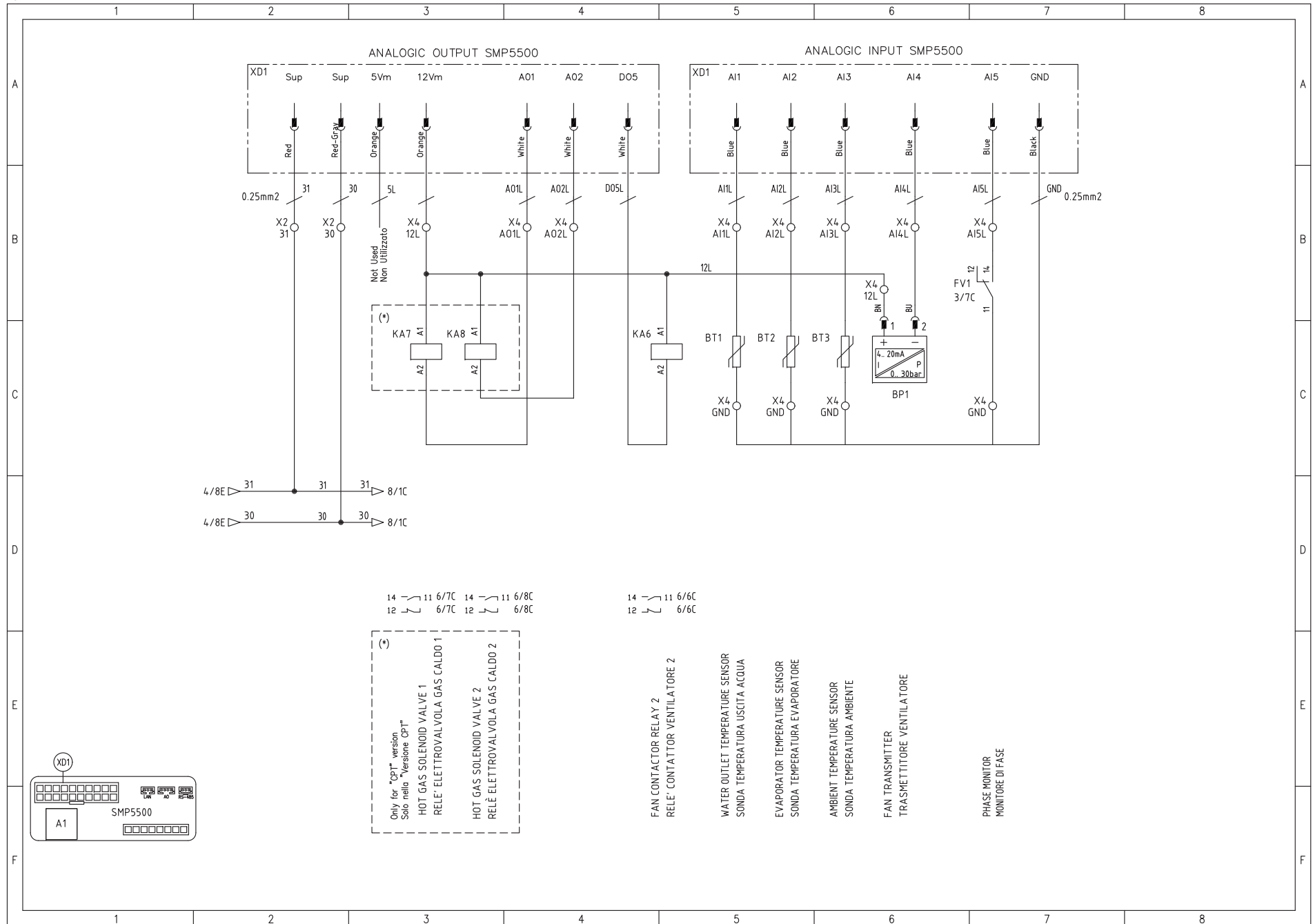

Wiring diagram ICEP022-027E (with option)

Sheet 7/15

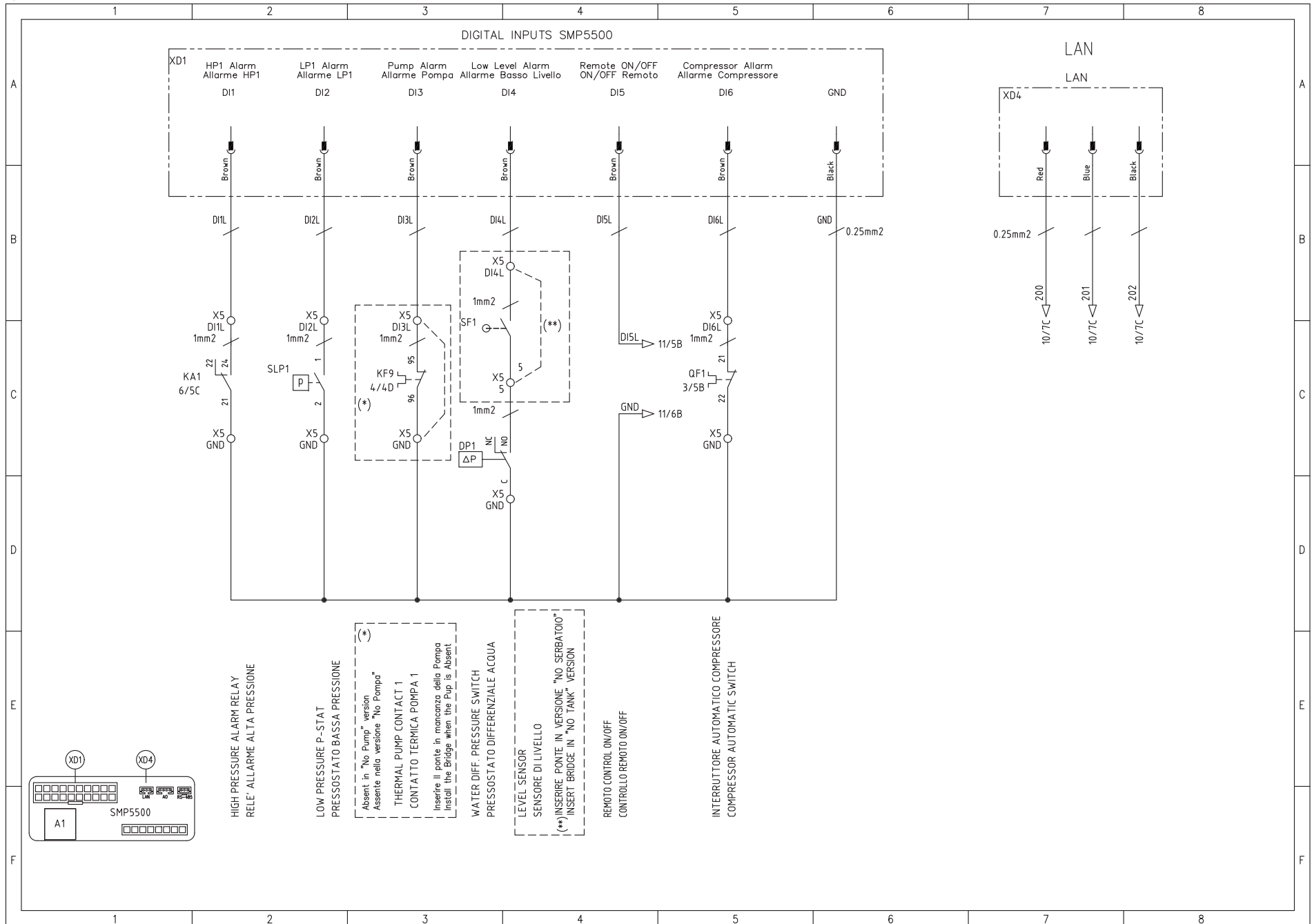

Wiring diagram ICEP022-027E (with option)

Sheet 8/15

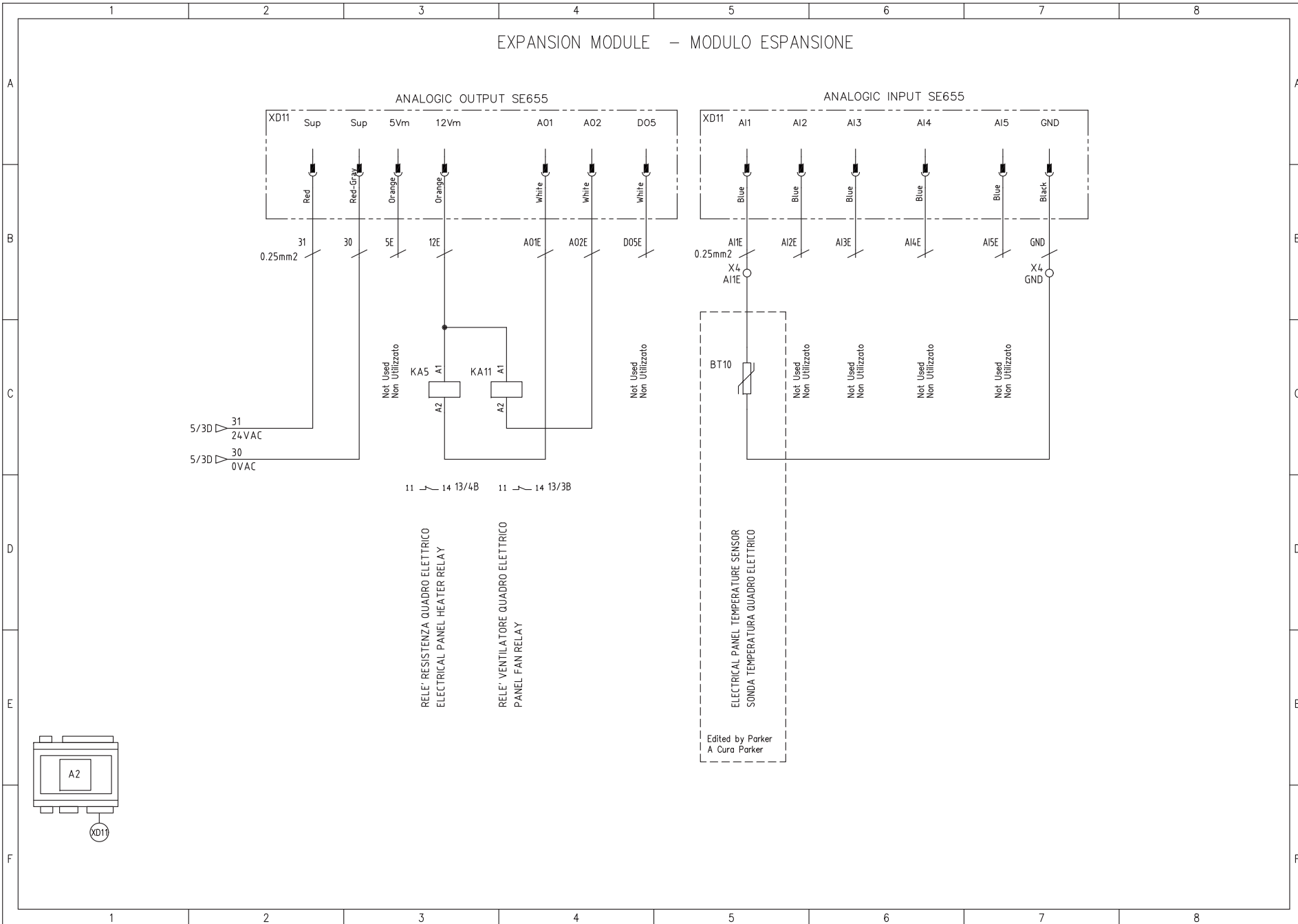

Wiring diagram ICEP022-027E (with option)

Sheet 9/15

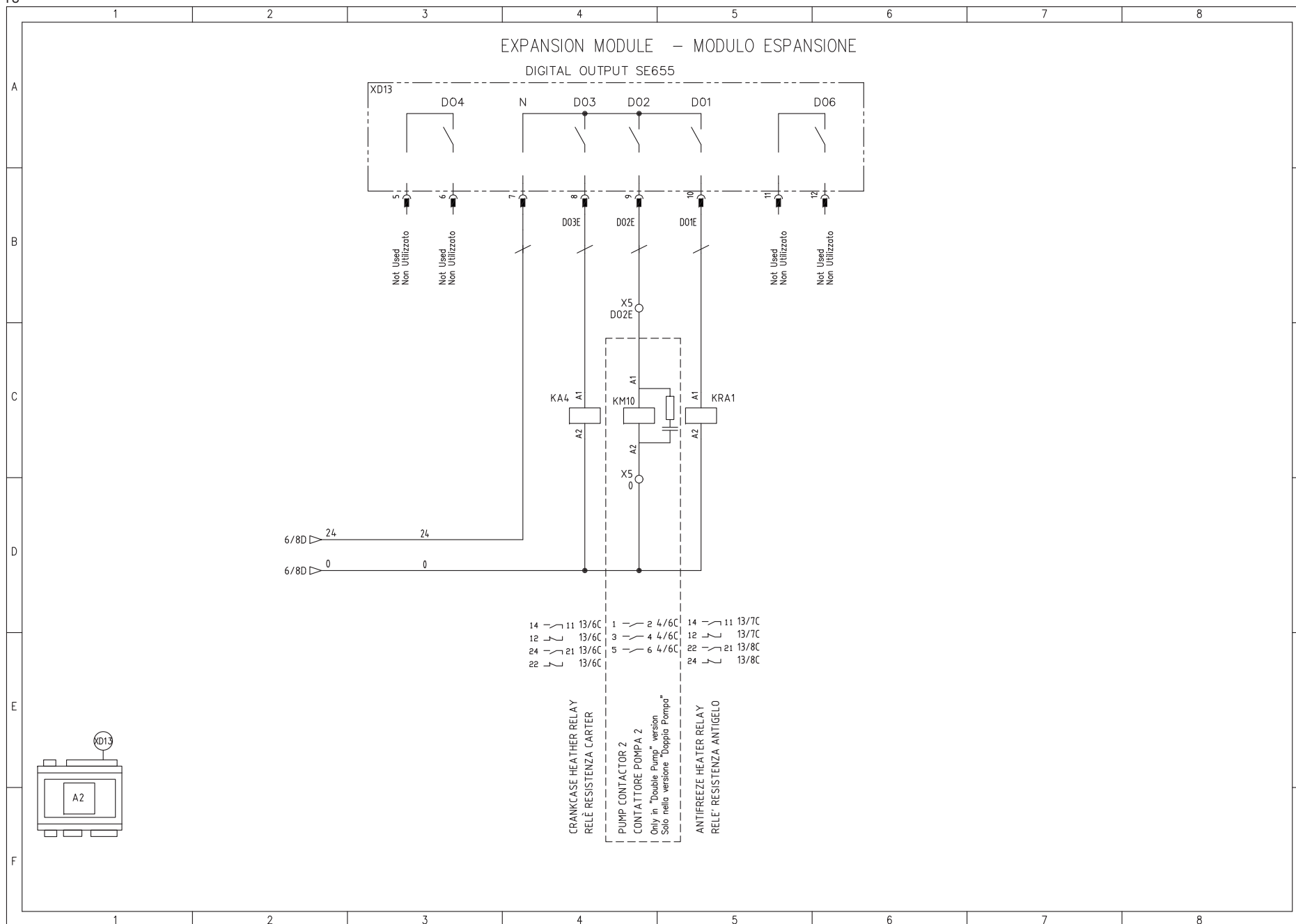

Wiring diagram ICEP022-027E (with option)

Sheet 10/15

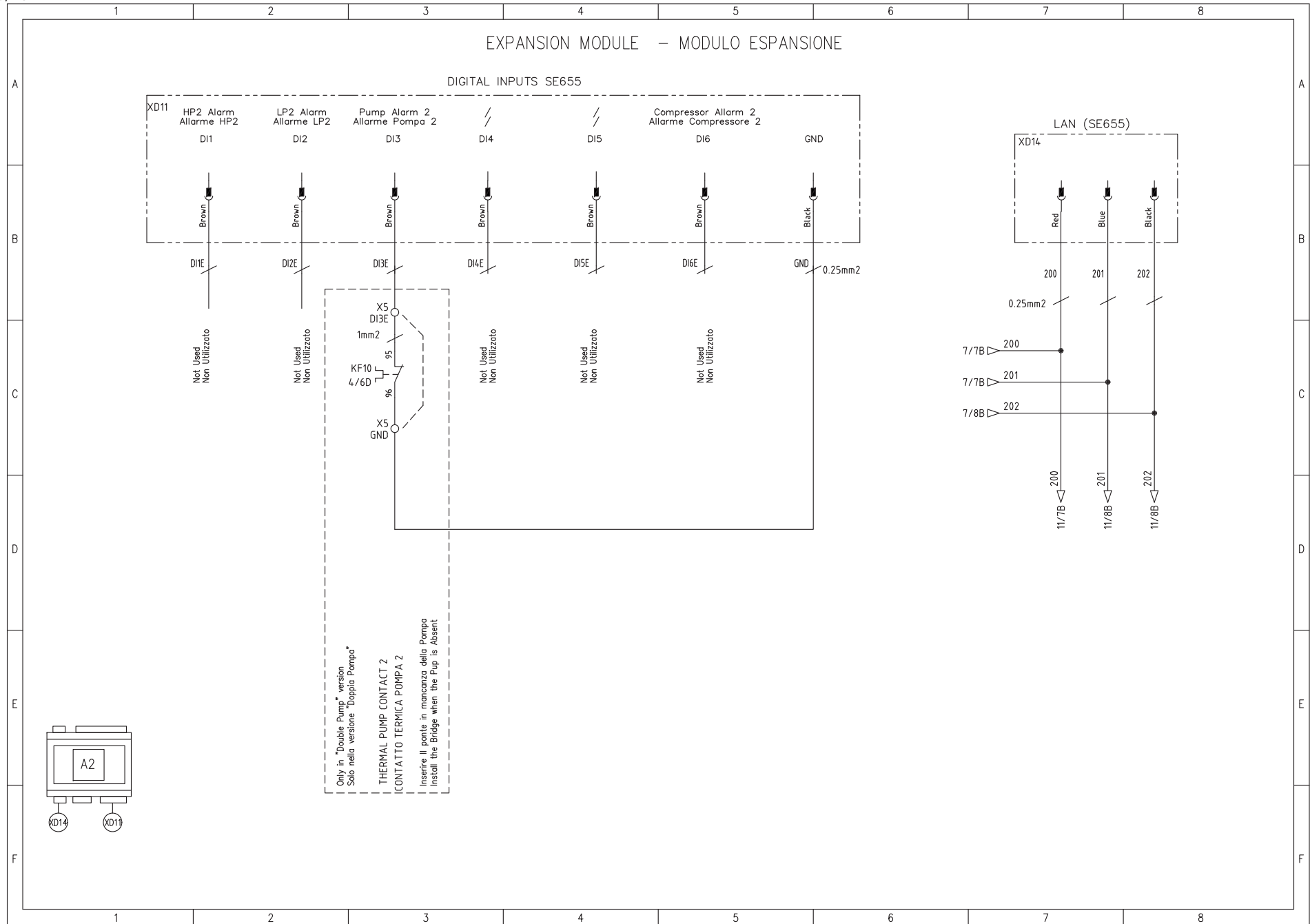

Wiring diagram ICEP022-027E (with option)

Sheet 11/15

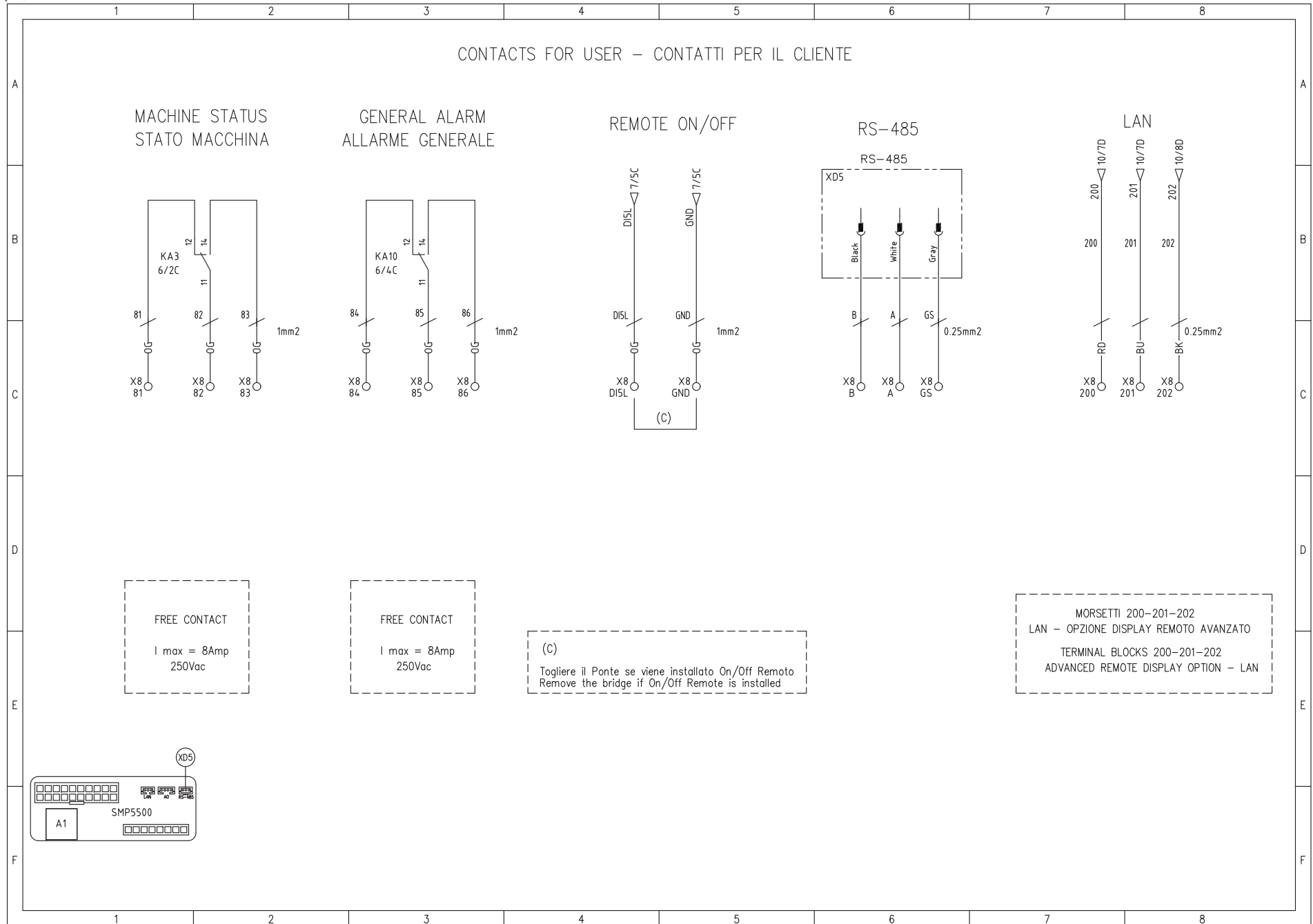

Wiring diagram ICEP022-027E (with option)

Sheet 12/15

OPTIONAL CONNECTIONS – COLLEGAMENTI OPZIONALI

Simple Remote Control – OPTION – Consult Parker
 OPZIONE – Controllo Remoto Semplice – Consultare Parker

A100

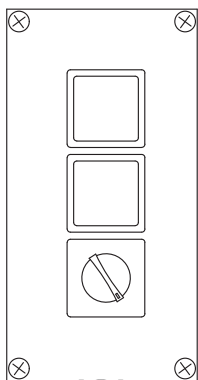

ON SIGNAL LAMP
 LAMPADA SEGNALAZIONE ON

ALARM SIGNAL LAMP
 LAMPADA SEGNALAZIONE ALLARME

INTERRUPTORE ON/OFF
 ON/OFF INTERRUPTER

Terminal Blocks XB
 Morsettiere XB

ADVANCE REMOTE Control – OPTION – Consult Parker
 OPZIONE – Controllo Remoto Avanzato – Consultare Parker

A103

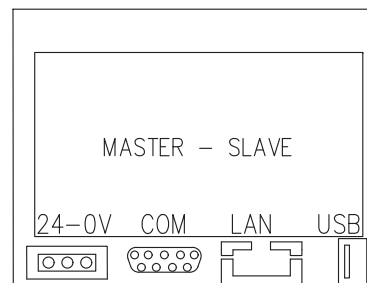

MASTER – SLAVE

MODBUS TCP-IP – OPTION – Consult Parker
 OPZIONE – MODBUS TCP-IP – Consultare Parker

A104

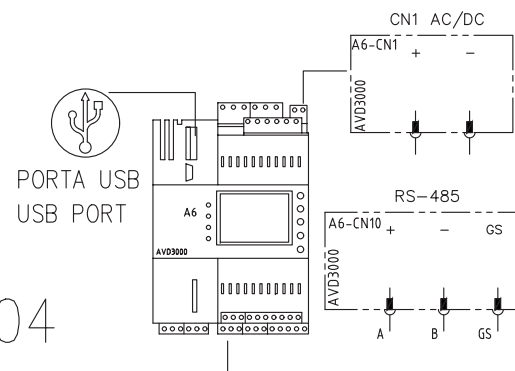

Wiring diagram ICEP022-027E (with option)

Sheet 13/15

OPTION TERMINAL BLOCKS – MORSETTI COLLEGAMENTI OPZIONI

Electrical Panel Heater/Fan
Resistenza Quadro Elettrico/Ventilazione

Crankcase Heater Compressor
Resistenza Carter compressore

Antifreeze Heater
Resistenza Antigelo

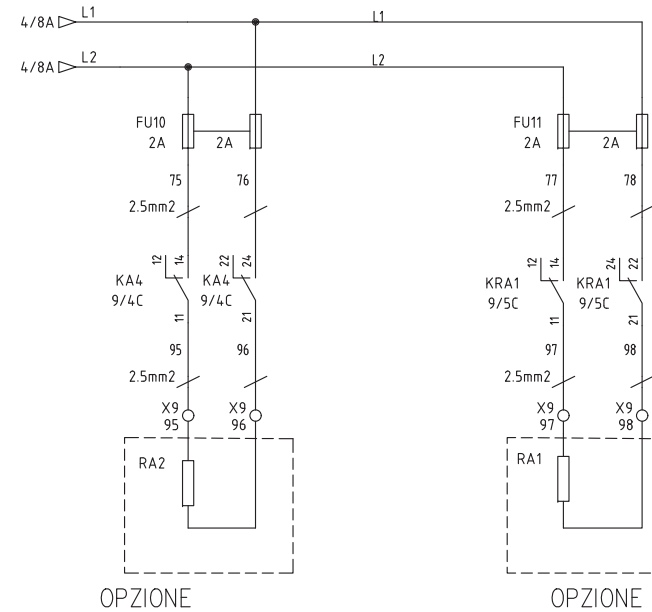
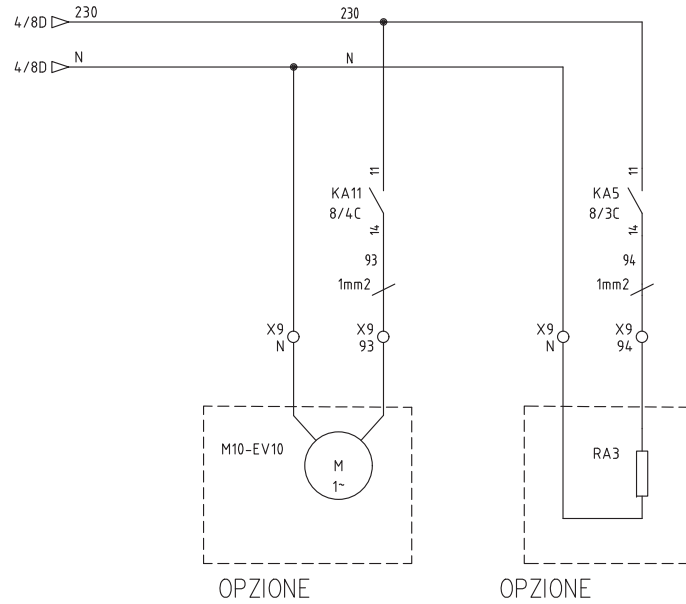

ELECTRICAL PANEL FAN MOTOR
MOTORE VENTILATORE QUADRO ELETTRICO

ELECTRICAL PANEL HEATER
RESISTENZA QUADRO ELETTRICO

CRANKCASE HEATHER
RESISTENZA CARTER

ANTIFREEZE HEATER
RESISTENZA ANTIFREEZE

Wiring diagram ICEP022-027E (with option)

Sheet 14/15

TERMINAL BLOCKS – MORSETTIERA 022–027

Phoenix Contact	3022276
Terminal Block	PT10 PE 3212131
Terminal	D-PT10 3212057
1 level	PT10 3212120
link 1 Level	D-PT10 3212057
2 level	PT10 3212120
link 2 Level	D-PT10 3212057
2 level	PT10 3212120
1 level	PT10 3212120
	Terminal Cover 3022276

Clipfix	3022276
control supply 24Vac	PT 2,5 - TW 3209549
control supply 24Vac	PT 2,5 - TW 3209549
Divider	ATP-ST-TW 3030789
control supply 24Vac	PT 2,5 - TW 3209549
control supply 24Vac	PT 2,5 - TW 3209549
Divider	ATP-ST-TW 3030789
aux. 24Vac	PT 2,5 - TW 3209549
aux. 24Vac	PT 2,5 - TW 3209549
Divider	ATP-ST-TW 3030789
aux. 24Vac	PT 2,5 - TW 3209549
Hot Gas Solenoid Valve 1	PTTB 1,5/S 3208511
Hot Gas Solenoid Valve 2	PTTB 1,5/S 3208511
BP1 - Pressure Transmitter 1	PTTB 1,5/S 3208511
Divider	ATP-STTB4 3030747
Water probe BT1	PTTB 1,5/S 3208511
evaporator probe BT2	PTTB 1,5/S 3208511
ambient probe BT3	PTTB 1,5/S 3208511
Phase Monitor	ATP-STTB4 3030747
Divider	PTTB 1,5/S 3208511
Electrical Panel probe BT10	PTTB 1,5/S 3208511
Divider	ATP-STTB4 3030747
High pressure switch 1	PTTB 1,5/S 3208511
Low pressure switch 1	PTTB 1,5/S 3208511
Thermal Pump Protection 1	PTTB 1,5/S 3208511
Level Sensor / Differential Switch	PTTB 1,5/S 3208511
Thermal Compr. Protection 1	PTTB 1,5/S 3208511
Pressure diff. - Level Sensor	PTTB 1,5/S 3208511
Divider	ATP-STTB4 3030747
Contact Pump 2	PTTB 1,5/S 3208511
Thermal Pump Protection 2	PTTB 1,5/S 3208511
Divider	ATP-STTB4 3030747
Termica Vent. 1	PTTB 1,5/S 3208511
Termica Vent. 2	PTTB 1,5/S 3208511
High Pressure P-Stat 1	PTTB 1,5/S 3208511
Divider	ATP-STTB4 3030747
VV7	PTTB 1,5/S 3208511
VV8	PTTB 1,5/S 3208511
Divider	ATP-STTB4 3030747
Remote ON/OFF	PIT 2,5 3210567
Divider	ATP-STTB4 3030747
plant status/ general alarm	PIT 2,5 3210567
plant status/ general alarm	PIT 2,5 3210567
plant status/ general alarm	PIT 2,5 3210567
aux. 0-24Vac	PT 1,5/S 3208100
Divider	ATP-STTB4 3030747
Modbus RTU - RS485	PT 1,5/S 3208100
Modbus RTU - RS485	PT 1,5/S 3208100
Modbus RTU - RS485	PT 1,5/S 3208100
Divider	ATP-STTB4 3030747
LAN - remote display	PT 1,5/S 3208100
LAN - remote display	PT 1,5/S 3208100
LAN - remote display	PT 1,5/S 3208100
Divider	ATP-STTB4 3030747
Fan OE	PTTB 1,5/S 3208511
Res OE	PTTB 1,5/S 3208511
Res. Carter	PTTB 2.5 3209604
Res. Antifreeze	PTTB 2.5 3209604
Clipfix	3022276

Wiring diagram ICEP022-027E (with option)

Sheet 15/15

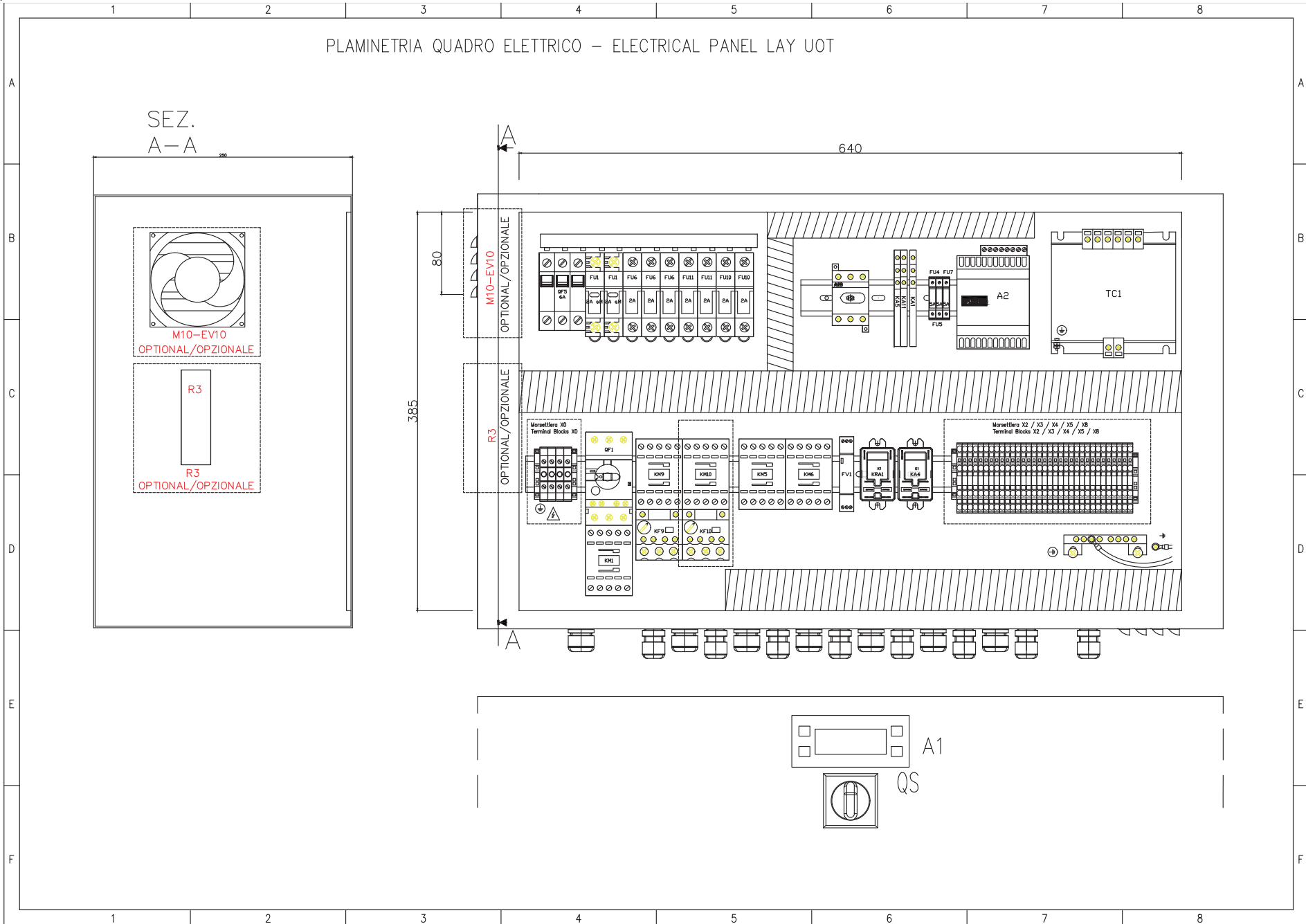

Wiring diagram ICEP008-015E (Fan speed option)

Sheet 1/15

MODEL MODELLO ICEP008-E	NOMINAL VOLTAGE TENSIONE NOMINALE Un (V) = 400				PHASES FASI Ph = 3				FREQUENCY FREQUENZA f (Hz) = 50				NOMINAL VOLTAGE TENSIONE NOMINALE Un (V) = 400				PHASES FASI Ph = 3				FREQUENCY FREQUENZA f (Hz) = 50				NOMINAL VOLTAGE TENSIONE NOMINALE Un (V) = 400V/3/50Hz			
	COMPRESSORS COMPRESSORI				FAN MOTOR ELETTOVENTILATORE				PUMP POMPA				MODEL - MODELLI ICEP008-E															
	SIGLA	FLA (A)	KW	LRA (A)	SIGLA	FLA (A)	KW	LRA (A)	SIGLA	FLA (A)	KW	LRA (A)	MCA (A)	MOP (A)	FLA (A) Tot.													
MC1	4.5	2.5	45	MF1	0.46	0.23	2.3	MP1 (P15)	1.4	λ	0.71	7.3	8	15	6.36													
								MP1 (P30)	1.65	λ	0.88	10.3	8	15	6.61													
								MP1 (P50)	3.3	λ	1.77	27.4	10	15	8.26													

MODEL MODELLO ICEP011-E	NOMINAL VOLTAGE TENSIONE NOMINALE Un (V) = 400				PHASES FASI Ph = 3				FREQUENCY FREQUENZA f (Hz) = 50				NOMINAL VOLTAGE TENSIONE NOMINALE Un (V) = 400				PHASES FASI Ph = 3				FREQUENCY FREQUENZA f (Hz) = 50				NOMINAL VOLTAGE TENSIONE NOMINALE Un (V) = 400V/3/50Hz			
	COMPRESSORS COMPRESSORI				FAN MOTOR ELETTOVENTILATORE				PUMP POMPA				MODEL - MODELLI ICEP011-E															
	SIGLA	FLA (A)	KW	LRA (A)	SIGLA	FLA (A)	KW	LRA (A)	SIGLA	FLA (A)	KW	LRA (A)	MCA (A)	MOP (A)	FLA (A) Tot.													
MC1	6.2	3.5	60	MF1	0.46	0.23	2.3	MP1 (P15)	1.4	λ	0.71	7.3	10	15	8.06													
								MP1 (P30)	1.65	λ	0.88	10.3	10	15	8.31													
								MP1 (P50)	3.3	λ	1.77	27.4	12	15	9.96													

MODEL MODELLO ICEP015-E	NOMINAL VOLTAGE TENSIONE NOMINALE Un (V) = 400				PHASES FASI Ph = 3				FREQUENCY FREQUENZA f (Hz) = 50				NOMINAL VOLTAGE TENSIONE NOMINALE Un (V) = 400				PHASES FASI Ph = 3				FREQUENCY FREQUENZA f (Hz) = 50				NOMINAL VOLTAGE TENSIONE NOMINALE Un (V) = 400V/3/50Hz			
	COMPRESSORS COMPRESSORI				FAN MOTOR ELETTOVENTILATORE				PUMP POMPA				MODEL - MODELLI ICEP015-E															
	SIGLA	FLA (A)	KW	LRA (A)	SIGLA	FLA (A)	KW	LRA (A)	SIGLA	FLA (A)	KW	LRA (A)	MCA (A)	MOP (A)	FLA (A) Tot.													
MC1	9.7	5.4	82	MF1	1.02	0.455	5.1	MP1 (P15)	1.4	λ	0.71	7.3	15	20	12.12													
								MP1 (P30)	1.78	λ	0.98	13.1	15	20	12.5													
								MP1 (P50)	3.3	λ	1.77	27.4	17	25	14.02													

FOLGIO/SHEET	DESCRIZIONE	DESCRIPTION
1	Dati Tecnici	Technical Data
2	Dati Tecnici	Technical Data
3	Circuito di Potenza	Power Circuit
4	Circuito di Potenza	Power Circuit
5	Circuito Ausiliario	Auxiliary Circuit
6	Circuito Ausiliario	Auxiliary Circuit
7	Circuito Ausiliario	Auxiliary Circuit
8	Modulo Espansione	Expansion Module
9	Modulo Espansione	Expansion Module
10	Modulo Espansione	Expansion Module
11	Contatti Cliente	Terminal Block for User
12	Collegamenti Opzionali	Optional Terminal Block
13	Collegamenti Opzionali	Optional Terminal Block
14	Morsettiera	Terminal Block
15	Planimetria Quadro Elettrico	Electrical Lay-Out
16	Lista Componenti	Component List
17	Lista Componenti	Component List
18	Lista Componenti	Component List
19	Lista Componenti	Component List
20	Lista Componenti Parker	Component List - Parker
21	Lista Componenti Parker	Component List - Parker

Wiring diagram ICEP008-015E (Fan speed option)

Sheet 2/15



	1	2	3	4	5	6	7	8																													
A	<table border="1"> <tr> <td>SUPPLY VOLTAGE TENSIONE ALIMENTAZIONE</td> <td>400V 3Ph 50Hz</td> </tr> <tr> <td>CONTROL VOLTAGE TENSIONE AUSILIARI</td> <td>0-24 VAC / 0-230 VAC</td> </tr> <tr> <td>ENCLOSED TYPE PROTEZIONE IP</td> <td>IP54</td> </tr> <tr> <td>RESIDUAL CURRENT SWITCH INTER. AUTOMATICO DIFFERENZIALE</td> <td>RCBO Id=0,03A CLASS A</td> </tr> <tr> <td>SCCR</td> <td>--</td> </tr> <tr> <td>GROUNDING MESSA A TERRA</td> <td>Solidly grounded</td> </tr> <tr> <td>CABLES SIZE SUPPLY CAVI INGRESSO ALIMENTAZIONE</td> <td>See Table (MCA)</td> </tr> </table>		SUPPLY VOLTAGE TENSIONE ALIMENTAZIONE	400V 3Ph 50Hz	CONTROL VOLTAGE TENSIONE AUSILIARI	0-24 VAC / 0-230 VAC	ENCLOSED TYPE PROTEZIONE IP	IP54	RESIDUAL CURRENT SWITCH INTER. AUTOMATICO DIFFERENZIALE	RCBO Id=0,03A CLASS A	SCCR	--	GROUNDING MESSA A TERRA	Solidly grounded	CABLES SIZE SUPPLY CAVI INGRESSO ALIMENTAZIONE	See Table (MCA)																					
SUPPLY VOLTAGE TENSIONE ALIMENTAZIONE	400V 3Ph 50Hz																																				
CONTROL VOLTAGE TENSIONE AUSILIARI	0-24 VAC / 0-230 VAC																																				
ENCLOSED TYPE PROTEZIONE IP	IP54																																				
RESIDUAL CURRENT SWITCH INTER. AUTOMATICO DIFFERENZIALE	RCBO Id=0,03A CLASS A																																				
SCCR	--																																				
GROUNDING MESSA A TERRA	Solidly grounded																																				
CABLES SIZE SUPPLY CAVI INGRESSO ALIMENTAZIONE	See Table (MCA)																																				
B																																					
C																																					
D	<table border="1"> <tr> <th colspan="3">Tightening Torque</th> </tr> <tr> <td colspan="3">  </td> </tr> <tr> <th>Component</th> <th>Nm</th> <th>Lb*In</th> </tr> <tr> <td>DILM9-10</td> <td>1,2000</td> <td>10,6000</td> </tr> <tr> <td>DILM15</td> <td>3.2000</td> <td>28.3000</td> </tr> <tr> <td>OT25F3</td> <td>0,8000</td> <td>7,0000</td> </tr> <tr> <td>BCH</td> <td>2,5000</td> <td>22,0000</td> </tr> <tr> <td>M4_8SFL</td> <td>0,8000</td> <td>7,0000</td> </tr> <tr> <td>FV1</td> <td>0,5000</td> <td>4,4000</td> </tr> <tr> <td>PKZM6.3 / 10</td> <td>1,7000</td> <td>15,0000</td> </tr> </table>		Tightening Torque						Component	Nm	Lb*In	DILM9-10	1,2000	10,6000	DILM15	3.2000	28.3000	OT25F3	0,8000	7,0000	BCH	2,5000	22,0000	M4_8SFL	0,8000	7,0000	FV1	0,5000	4,4000	PKZM6.3 / 10	1,7000	15,0000					
Tightening Torque																																					
																																					
Component	Nm	Lb*In																																			
DILM9-10	1,2000	10,6000																																			
DILM15	3.2000	28.3000																																			
OT25F3	0,8000	7,0000																																			
BCH	2,5000	22,0000																																			
M4_8SFL	0,8000	7,0000																																			
FV1	0,5000	4,4000																																			
PKZM6.3 / 10	1,7000	15,0000																																			
E																																					
F																																					
	1	2	3	4	5	6	7	8																													

TABELLA COLORI CAVI - TABLE ELECTRICAL CABLES (Norme EN 60204-1)		
NERO - BLACK	BK	Conduttore di Potenza Principale in AC/DC - Main Power Circuits AC and DC
AZZURRO - LIGHT BLUE	BU	Conduttore di Neutro - Neutral Conductor
ROSSO - RED	RD	Circuiti di Comando in Corrente Alternata AC 12-24-230VAC - Control Circuits in AC 12-24-230VAC
BLU SCURO - DARK BLUE	DBU	Circuiti di Comando in Corrente Continua DC 24VDC - Control Circuits in DC 24VDC
ARANCIONE - ORANGE	OG	Circuiti Segnali in Tensione - Voltage Signal Circuits
BIANCO - WHITE	WH	Circuiti di Misura - Measuring Circuits
GIALLO-VERDE	GNYE	Conduttore di Terra - Grounded Conductors

Wiring diagram ICEP008-015E (Fan speed option)

Sheet 3/15

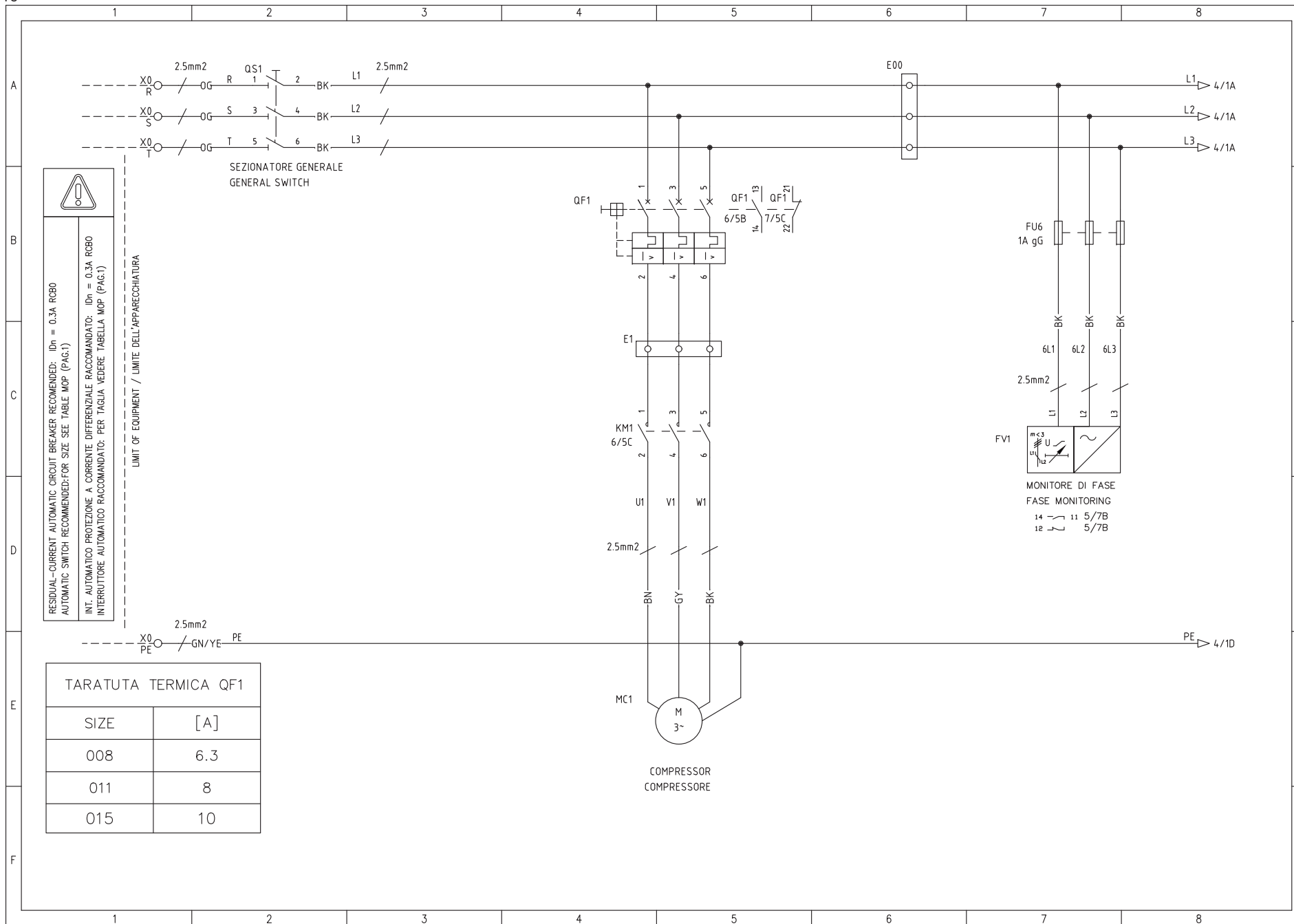

Wiring diagram ICEP008-015E (Fan speed option)

Sheet 4/15

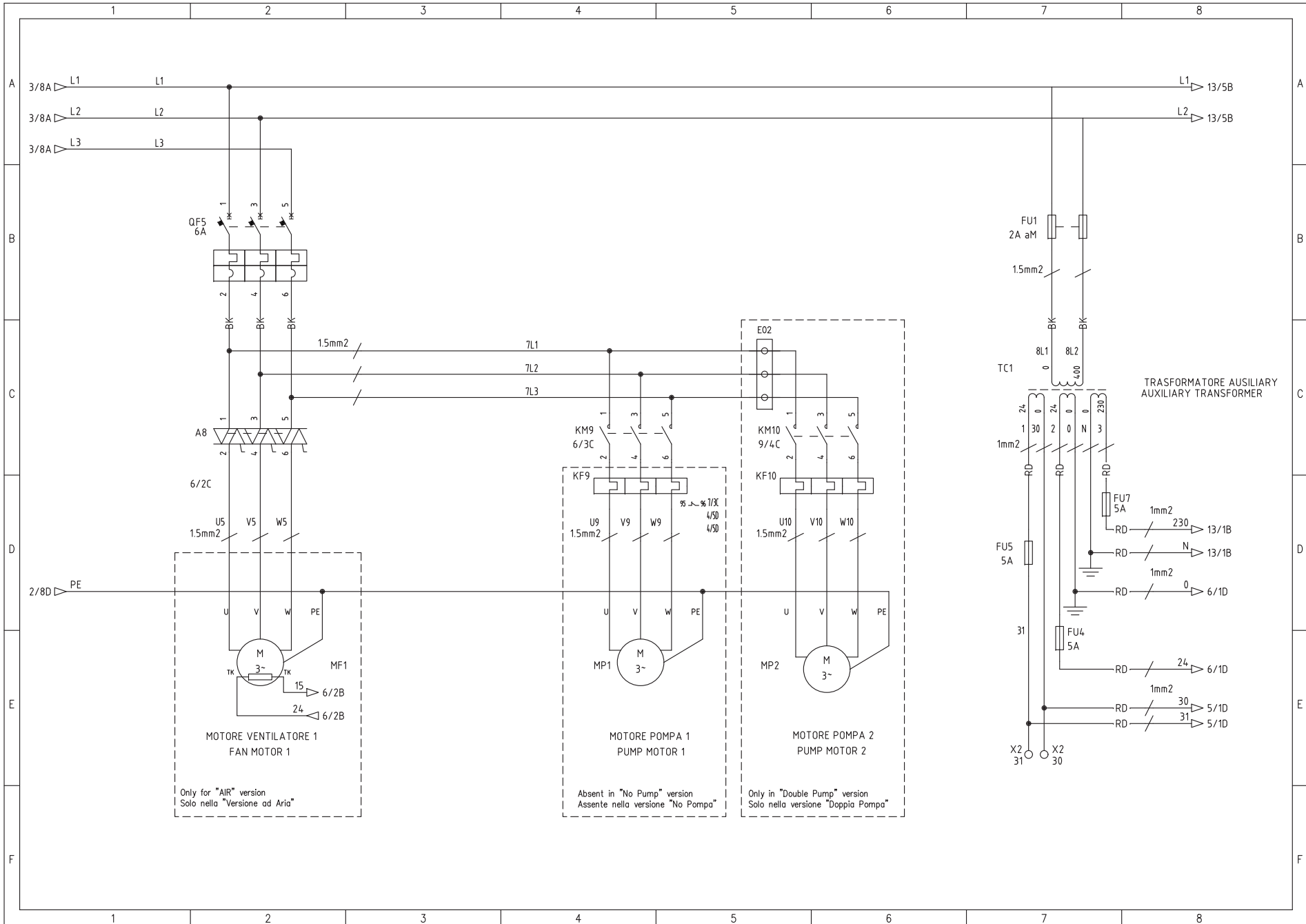

Wiring diagram ICEP008-015E (Fan speed option)

Sheet 5/15

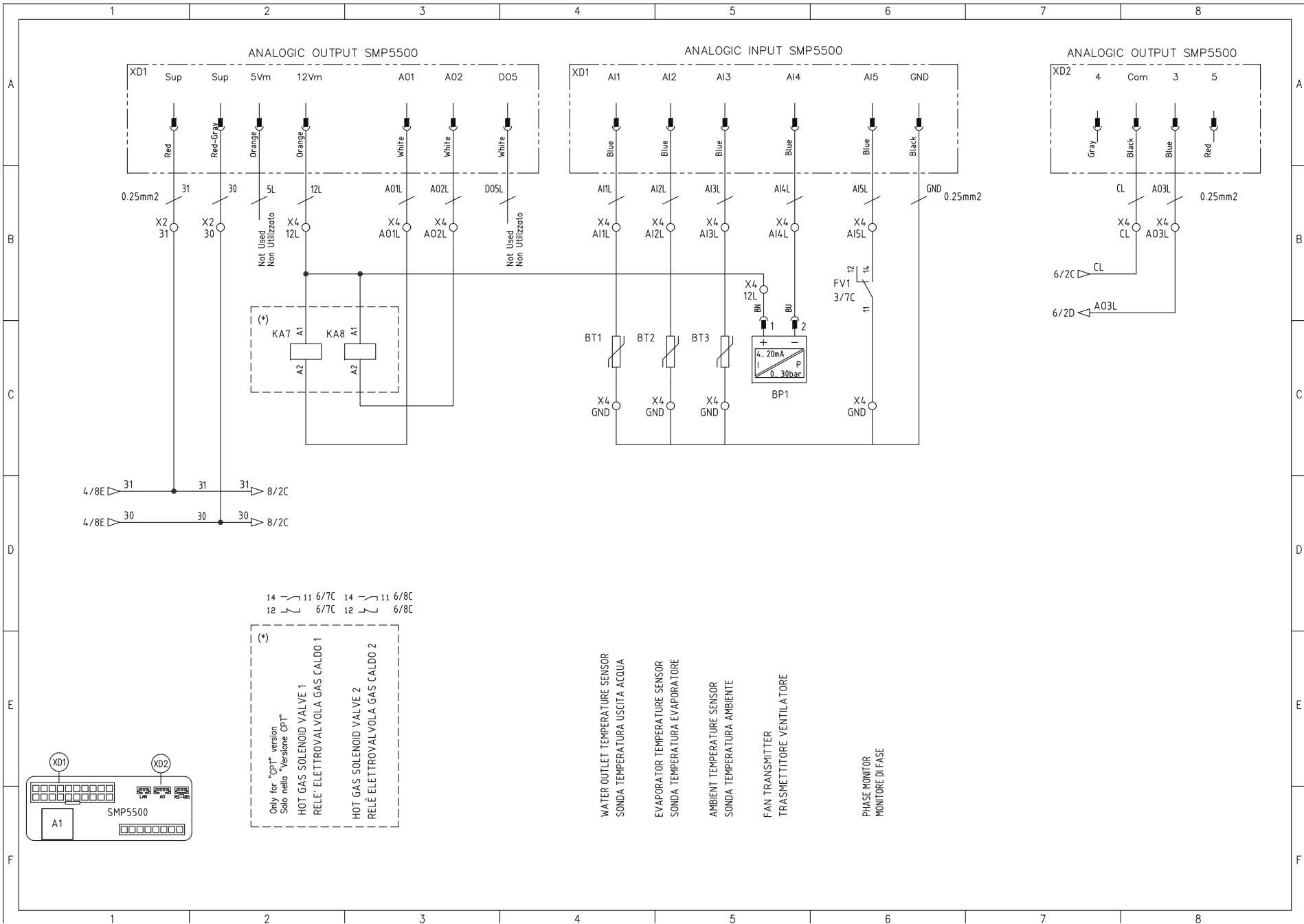

Wiring diagram ICEP008-015E (Fan speed option)

Sheet 6/15

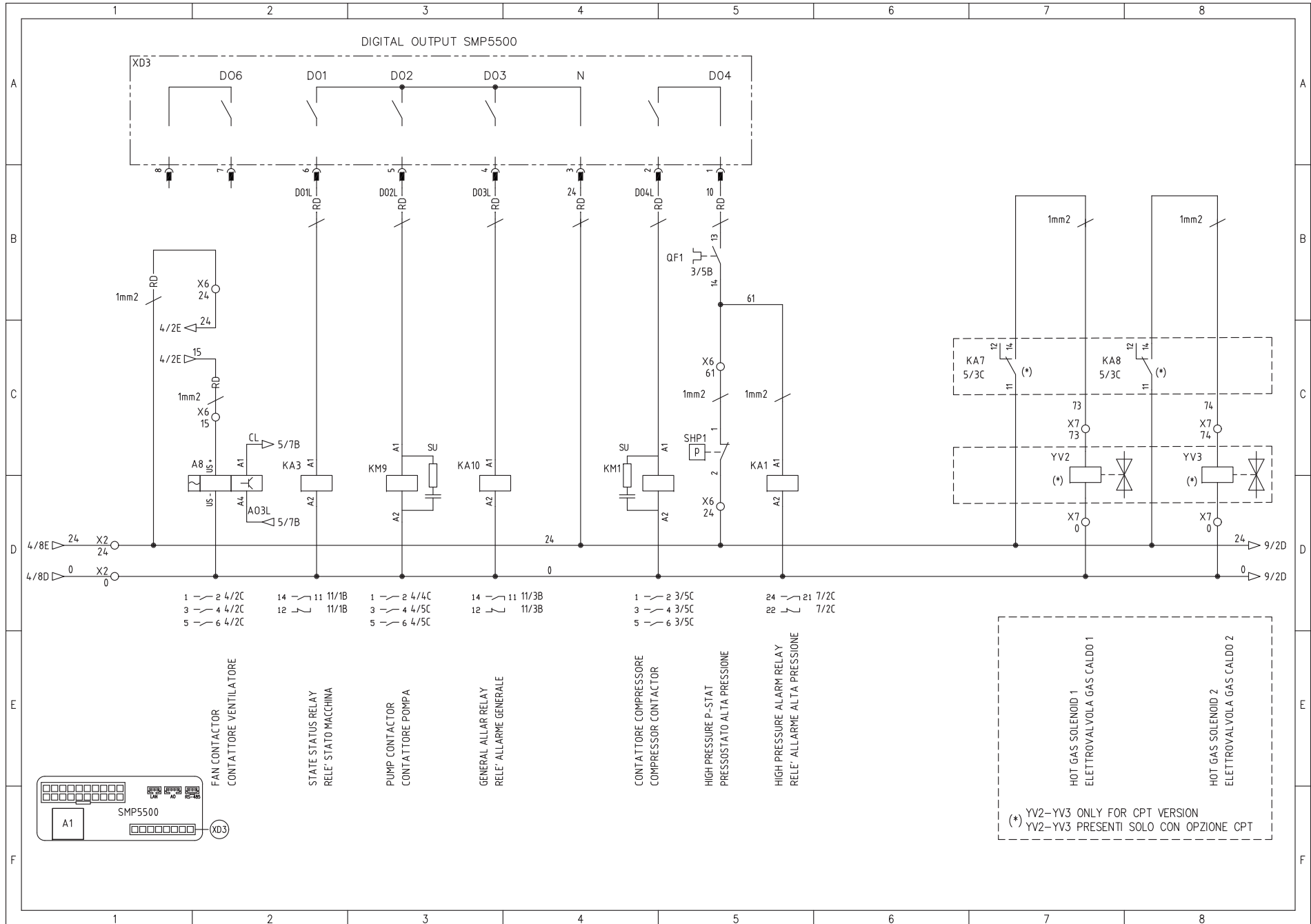

Wiring diagram ICEP008-015E (Fan speed option)

Sheet 7/15

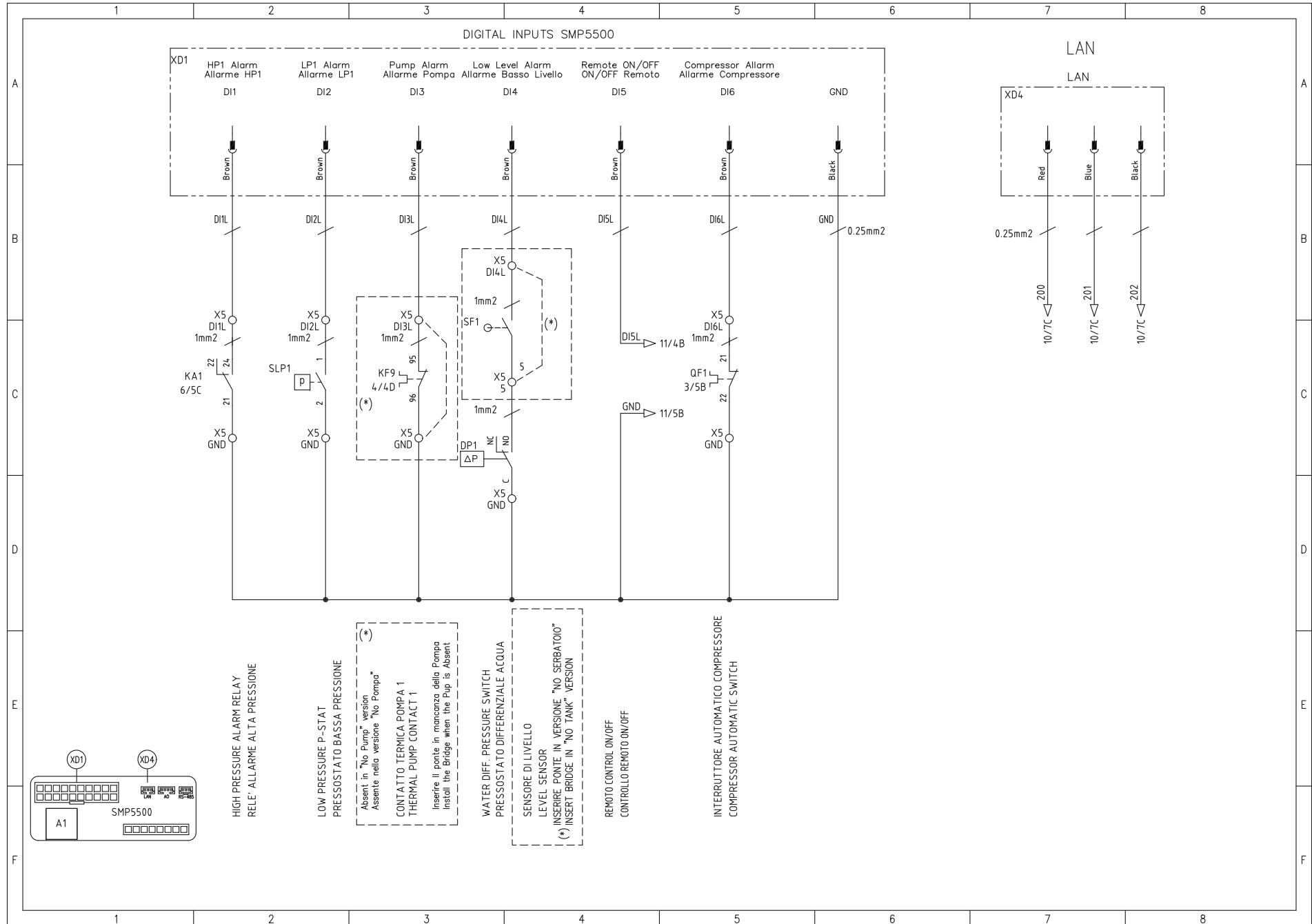

Wiring diagram ICEP008-015E (Fan speed option)

Sheet 8/15

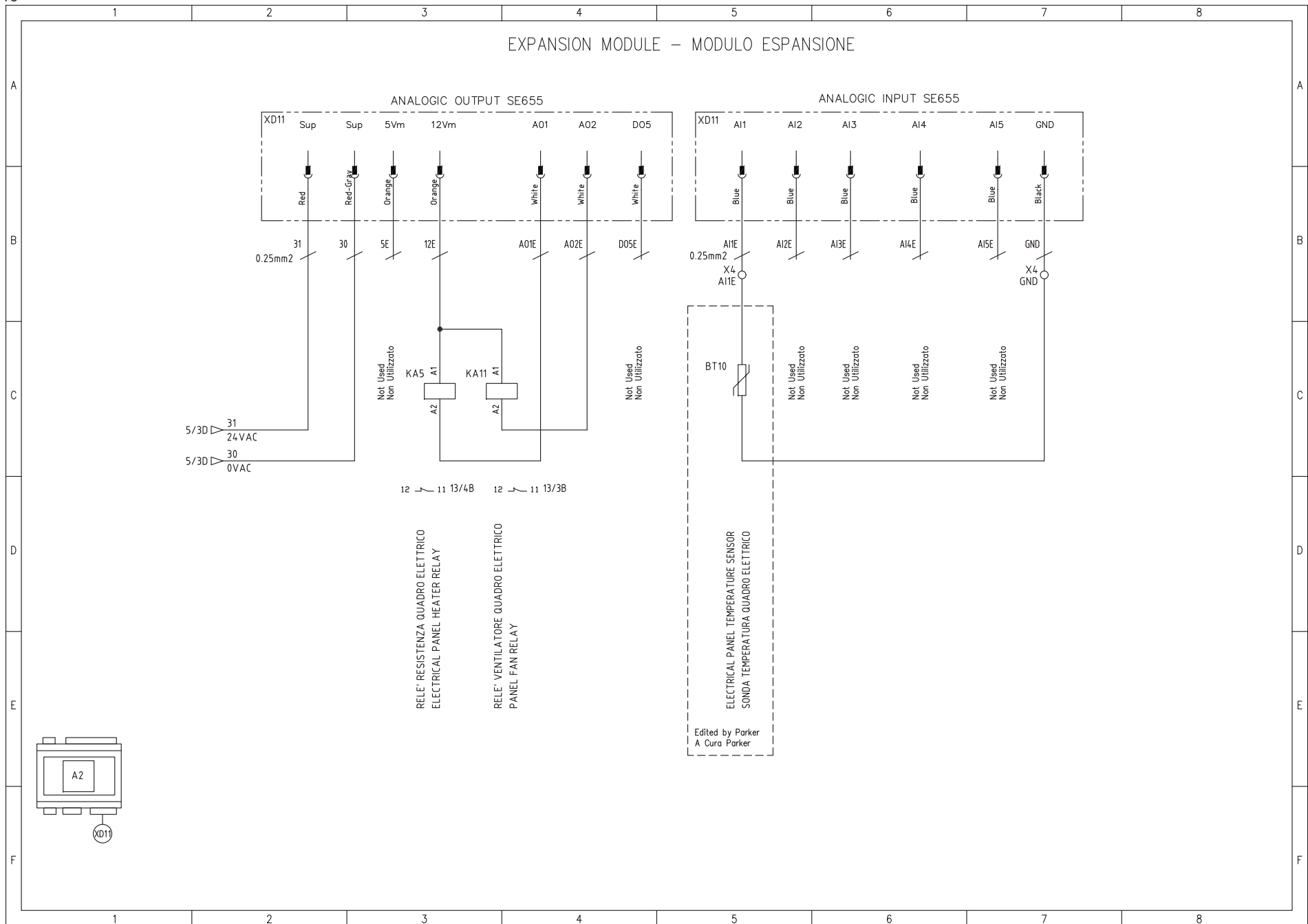

Wiring diagram ICEP008-015E (Fan speed option)

Sheet 9/15

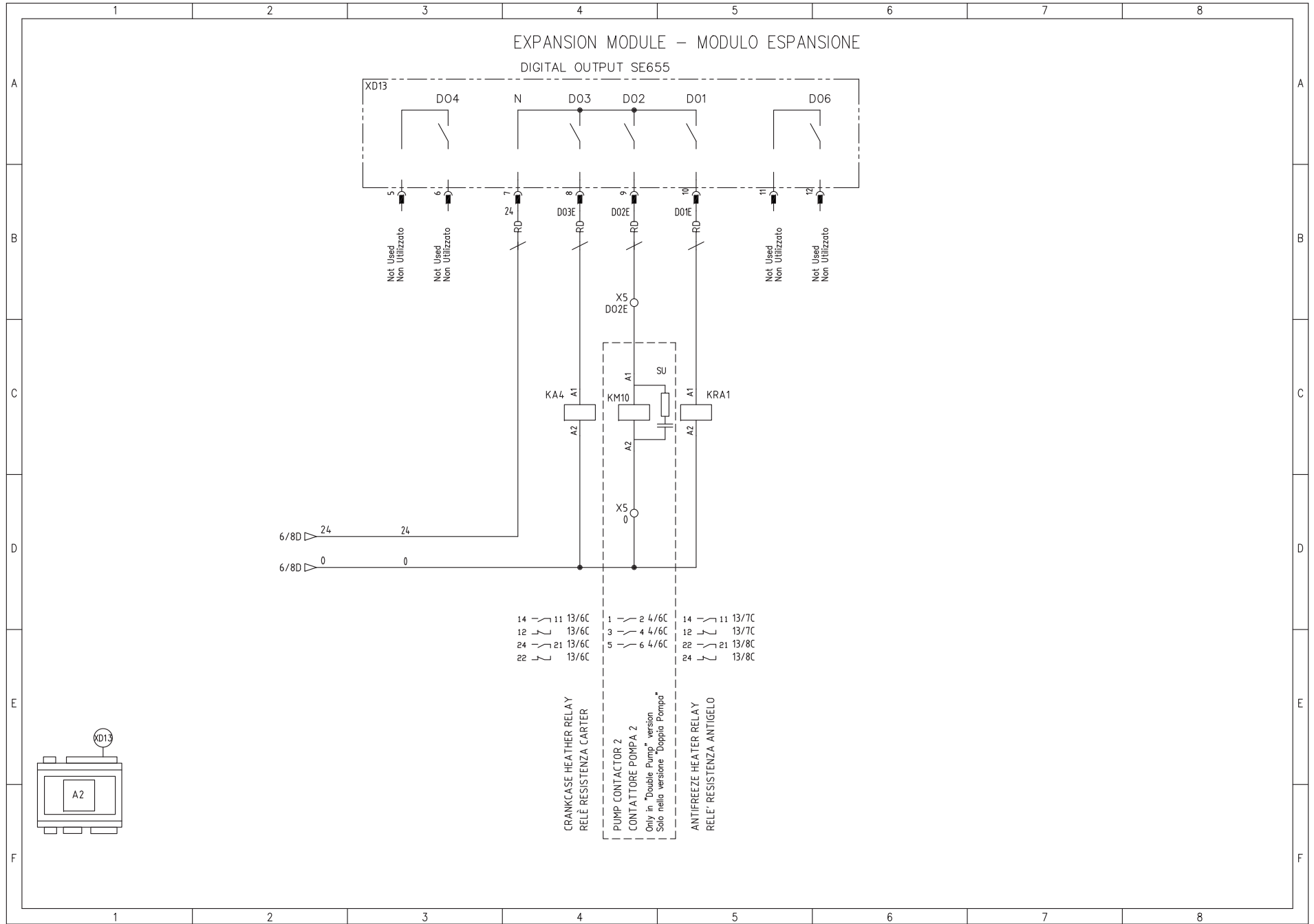

Wiring diagram ICEP008-015E (Fan speed option)

Sheet 10/15

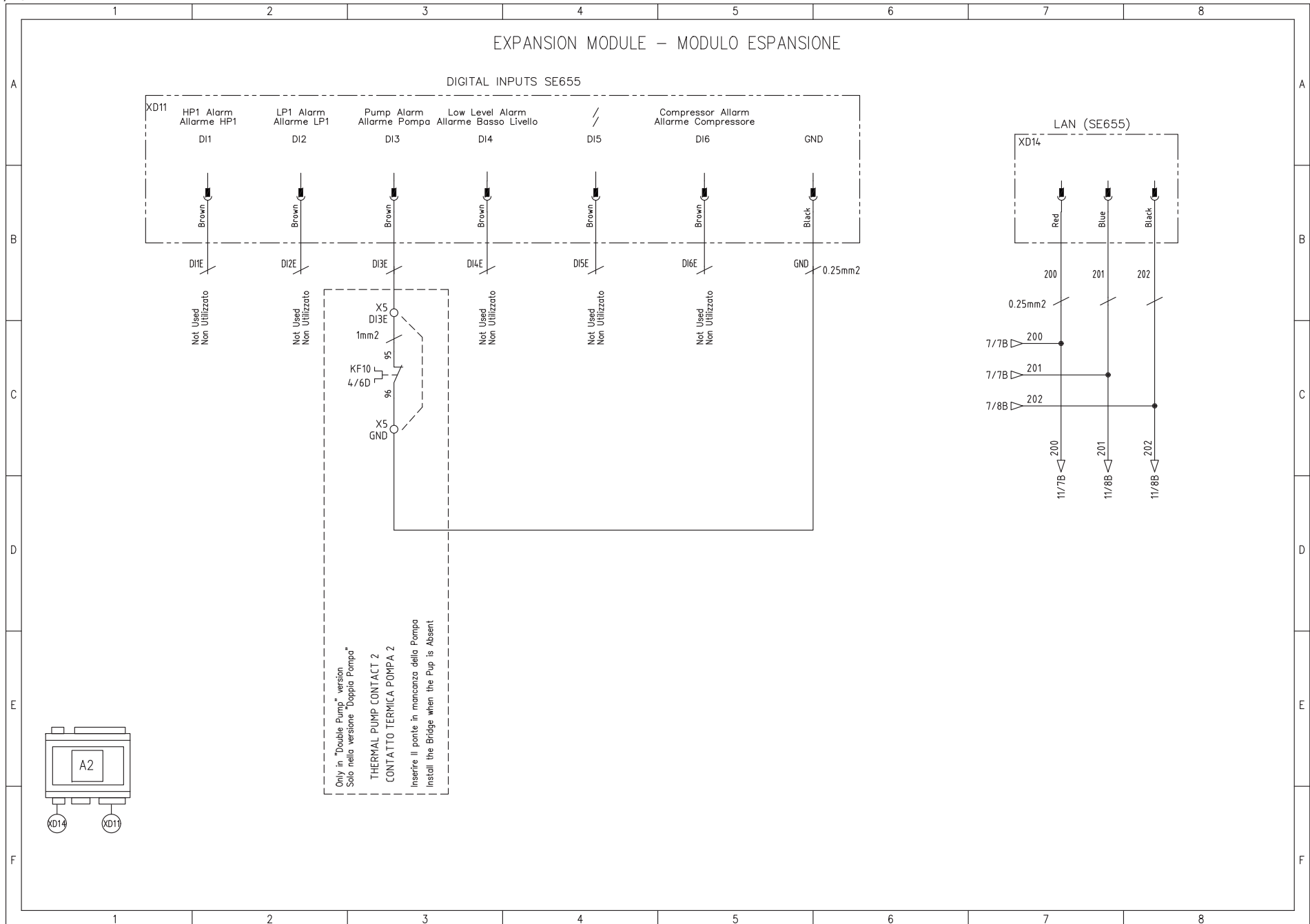

Wiring diagram ICEP008-015E (Fan speed option)

Sheet 11/15

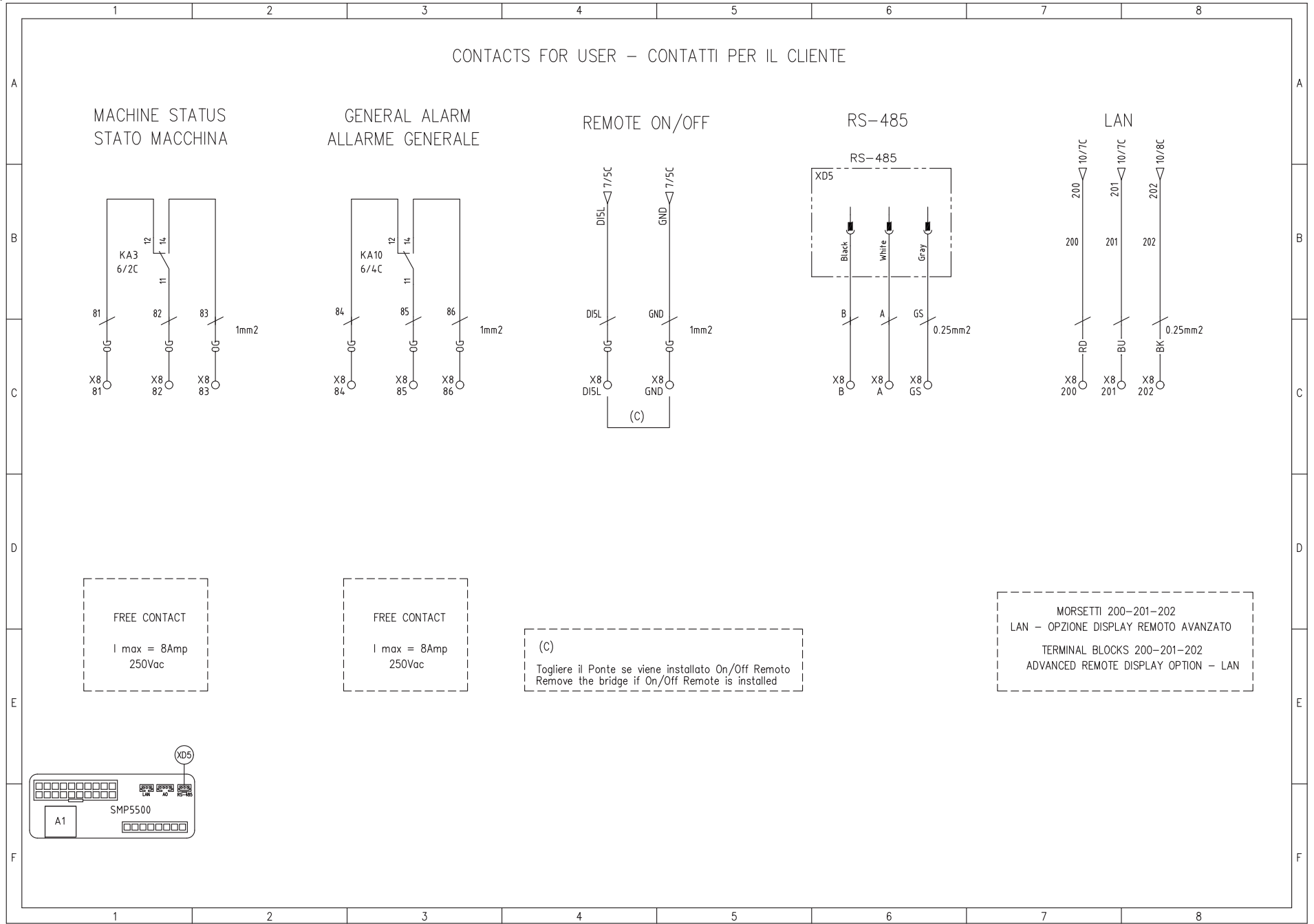

Wiring diagram ICEP008-015E (Fan speed option)

Sheet 12/15

OPTIONAL CONNECTIONS – COLLEGAMENTI OPZIONALI

Simple Remote Control – OPTION – Consult Parker
 OPZIONE – Controllo Remoto Semplice – Consultare Parker

A100

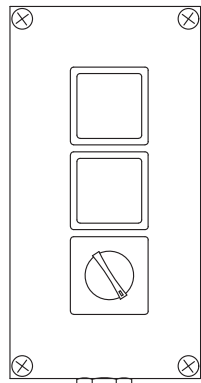

Terminal Blocks XB
 Morsettiere XB

ON SIGNAL LAMP
 LAMPADA SEGNALAZIONE ON

ALARM SIGNAL LAMP
 LAMPADA SEGNALAZIONE ALLARME

INTERRUPTORE ON/OFF
 ON/OFF INTERRUPTER

ADVANCE REMOTE Control – OPTION – Consult Parker
 OPZIONE – Controllo Remoto Avanzato – Consultare Parker

A103

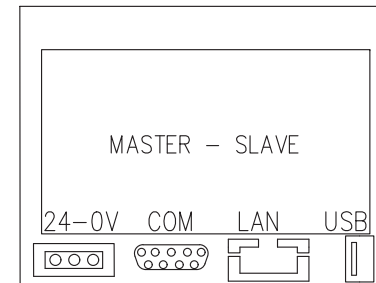

MASTER – SLAVE

MODBUS TCP-IP – OPTION – Consult Parker
 OPZIONE – MODBUS TCP-IP – Consultare Parker

A104

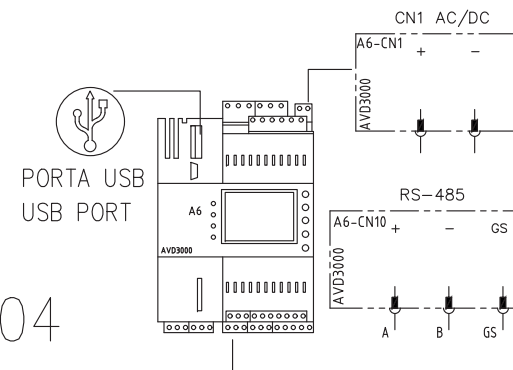

Wiring diagram ICEP008-015E (Fan speed option)

Sheet 13/15

OPTION TERMINAL BLOCKS – MORSETTI COLLEGAMENTI OPZIONI

Electrical Panel Heater/Fan
Resistenza Quadro Elettrico/Ventilazione

Crankcase Heater Compressor
Resistenza Carter compressore

Antifreeze Heater
Resistenza Antigelo

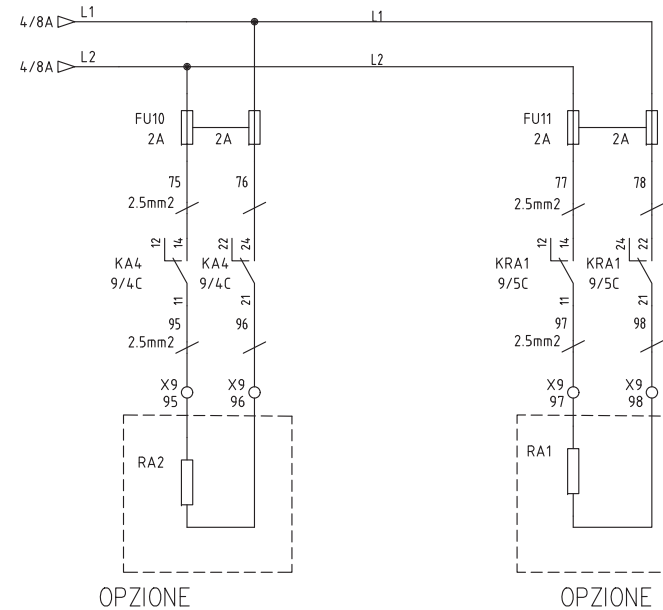
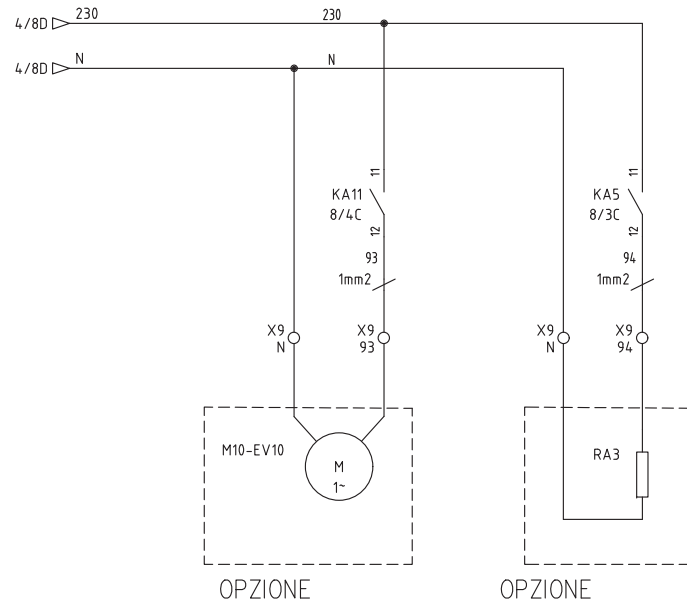

ELECTRICAL PANEL FAN MOTOR
MOTORE VENTILATORE QUADRO ELETTRICO

ELECTRICAL PANEL HEATER
RESISTENZA QUADRO ELETTRICO

CRANKCASE HEATER
RESISTENZA CARTER

ANTIFREEZE HEATER
RESISTENZA ANTIFREEZE

Wiring diagram ICEP008-015E (Fan speed option)

Sheet 15/15

PLAMINETRIA QUADRO ELETTRICO – ELECTRICAL PANEL LAY UOT

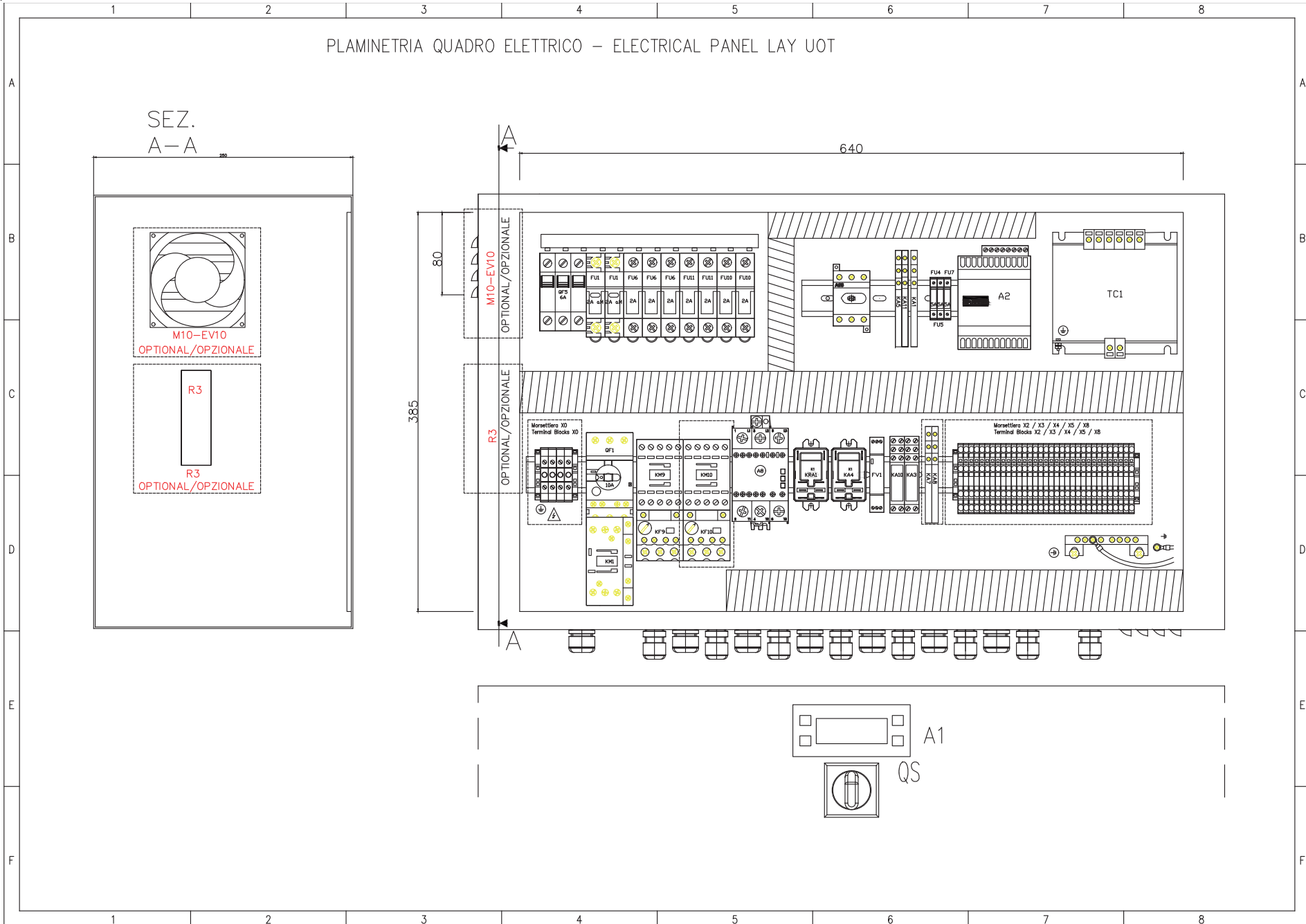

Wiring diagram ICEP022-027E (Fan speed option)

Sheet 1/15

MODELLO MODELLO ICEP022-E	NOMINAL VOLTAGE PHASES FREQUENCY TENSIONE NOMINALE FASI FREQUENZA Un (V) = 400 Ph = 3 f (Hz) = 50				NOMINAL VOLTAGE PHASES FREQUENCY TENSIONE NOMINALE FASI FREQUENZA Un (V) = 400 Ph = 3 f (Hz) = 50				NOMINAL VOLTAGE PHASES FREQUENCY TENSIONE NOMINALE FASI FREQUENZA Un (V) = 400 Ph = 3 f (Hz) = 50				NOMINAL VOLTAGE TENSIONE NOMINALE Un (V) = 400V/3/50Hz		
	COMPRESSORS COMPRESSORI				FAN MOTOR ELETTROVENTILATORE				PUMP POMPA				MODEL - MODELLI ICEP022-E		
	SIGLA	FLA (A)	KW	LRA (A)	SIGLA	FLA (A)	KW	LRA (A)	SIGLA	FLA (A)	KW	LRA (A)	MCA (A)	MOP (A)	FLA (A) Tot.
MC1	11.8	6.5	95	MF1	1,02 λ	0,455	5.1	MP1 (P15)	1.4	0.71	7.3	19	25	15.24	
				MF2	1,02 λ	0,455	5.1	MP1 (P30)	2.37	1.28	19.7	20	30	16.21	
								MP1 (P50)	3.3	1.77	27.4	21	30	17.14	

MODELLO MODELLO ICEP027-E	NOMINAL VOLTAGE PHASES FREQUENCY TENSIONE NOMINALE FASI FREQUENZA Un (V) = 400 Ph = 3 f (Hz) = 50				NOMINAL VOLTAGE PHASES FREQUENCY TENSIONE NOMINALE FASI FREQUENZA Un (V) = 400 Ph = 3 f (Hz) = 50				NOMINAL VOLTAGE PHASES FREQUENCY TENSIONE NOMINALE FASI FREQUENZA Un (V) = 400 Ph = 3 f (Hz) = 50				NOMINAL VOLTAGE TENSIONE NOMINALE Un (V) = 400V/3/50Hz		
	COMPRESSORS COMPRESSORI				FAN MOTOR ELETTROVENTILATORE				PUMP POMPA				MODEL - MODELLI ICEP027-E		
	SIGLA	FLA (A)	KW	LRA (A)	SIGLA	FLA (A)	KW	LRA (A)	SIGLA	FLA (A)	KW	LRA (A)	MCA (A)	MOP (A)	FLA (A) Tot.
MC1	18.3	8.7	140	MF1	1,02 λ	0,455	5.1	MP1 (P15)	1.7	0.91	11.8	27	40	22.04	
				MF2	1,02 λ	0,455	5.1	MP1 (P30)	2.37	1.28	19.7	28	45	22.71	
								MP1 (P50)	4.7	2.55	38.4	30	45	25.04	

FOLGIO/SHEET	DESCRIZIONE	DESCRIPTION
1	Dati Tecnici	Technical Data
2	Dati Tecnici	Technical Data
3	Circuito di Potenza	Power Circuit
4	Circuito di Potenza	Power Circuit
5	Circuito Ausiliario	Auxiliary Circuit
6	Circuito Ausiliario	Auxiliary Circuit
7	Circuito Ausiliario	Auxiliary Circuit
8	Modulo Espansione	Expansion Module
9	Modulo Espansione	Expansion Module
10	Modulo Espansione	Expansion Module
11	Contatti Cliente	Terminal Block for User
12	Collegamenti Opzionali	Optional Terminal Block
13	Collegamenti Opzionali	Optional Terminal Block
14	Marsettiera	Terminal Block
15	Planimetria Quadro Elettrico	Electrical Lay-Out
16	Lista Componenti	Component List
17	Lista Componenti	Component List
18	Lista Componenti	Component List
19	Lista Componenti	Component List
20	Lista Componenti Parker	Component List - Parker
21	Lista Componenti Parker	Component List - Parker

Wiring diagram ICEP022-027E (Fan speed option)

Sheet 2/15

	1	2	3	4	5	6	7	8																													
A	<table border="1"> <tr> <td>SUPPLY VOLTAGE TENSIONE ALIMENTAZIONE</td> <td>400V 3Ph 50Hz</td> </tr> <tr> <td>CONTROL VOLTAGE TENSIONE AUSILIARI</td> <td>0-24 VAC / 0-230 VAC</td> </tr> <tr> <td>ENCLOSED TYPE PROTEZIONE IP</td> <td>IP54</td> </tr> <tr> <td>RESIDUAL CURRENT SWITCH INTER. AUTOMATICO DIFFERENZIALE</td> <td>RCBO Id=0,03A CLASS A</td> </tr> <tr> <td>SCCR</td> <td>--</td> </tr> <tr> <td>GROUNDING MESSA A TERRA</td> <td>Solidly grounded</td> </tr> <tr> <td>CABLES SIZE SUPPLY CAVI INGRESSO ALIMENTAZIONE</td> <td>See Table (MCA)</td> </tr> </table>		SUPPLY VOLTAGE TENSIONE ALIMENTAZIONE	400V 3Ph 50Hz	CONTROL VOLTAGE TENSIONE AUSILIARI	0-24 VAC / 0-230 VAC	ENCLOSED TYPE PROTEZIONE IP	IP54	RESIDUAL CURRENT SWITCH INTER. AUTOMATICO DIFFERENZIALE	RCBO Id=0,03A CLASS A	SCCR	--	GROUNDING MESSA A TERRA	Solidly grounded	CABLES SIZE SUPPLY CAVI INGRESSO ALIMENTAZIONE	See Table (MCA)																					
SUPPLY VOLTAGE TENSIONE ALIMENTAZIONE	400V 3Ph 50Hz																																				
CONTROL VOLTAGE TENSIONE AUSILIARI	0-24 VAC / 0-230 VAC																																				
ENCLOSED TYPE PROTEZIONE IP	IP54																																				
RESIDUAL CURRENT SWITCH INTER. AUTOMATICO DIFFERENZIALE	RCBO Id=0,03A CLASS A																																				
SCCR	--																																				
GROUNDING MESSA A TERRA	Solidly grounded																																				
CABLES SIZE SUPPLY CAVI INGRESSO ALIMENTAZIONE	See Table (MCA)																																				
B																																					
C																																					
D	<table border="1"> <tr> <th colspan="3">Tightening Torque</th> </tr> <tr> <td colspan="3" style="text-align: center;">  </td> </tr> <tr> <th>Component</th> <th>Nm</th> <th>Lb*In</th> </tr> <tr> <td>DILM9-10</td> <td>1,2000</td> <td>10,6000</td> </tr> <tr> <td>DILM15/25</td> <td>1,2000</td> <td>10,6000</td> </tr> <tr> <td>OT063F3</td> <td>0,8000</td> <td>7</td> </tr> <tr> <td>BCH</td> <td>2,5000</td> <td>22,0000</td> </tr> <tr> <td>M4_8SFL</td> <td>0,8000</td> <td>7,0000</td> </tr> <tr> <td>FV1</td> <td>0,5000</td> <td>4,4000</td> </tr> <tr> <td>PKZM16 / 20</td> <td>1,7000</td> <td>15,0000</td> </tr> </table>		Tightening Torque						Component	Nm	Lb*In	DILM9-10	1,2000	10,6000	DILM15/25	1,2000	10,6000	OT063F3	0,8000	7	BCH	2,5000	22,0000	M4_8SFL	0,8000	7,0000	FV1	0,5000	4,4000	PKZM16 / 20	1,7000	15,0000					
Tightening Torque																																					
																																					
Component	Nm	Lb*In																																			
DILM9-10	1,2000	10,6000																																			
DILM15/25	1,2000	10,6000																																			
OT063F3	0,8000	7																																			
BCH	2,5000	22,0000																																			
M4_8SFL	0,8000	7,0000																																			
FV1	0,5000	4,4000																																			
PKZM16 / 20	1,7000	15,0000																																			
E																																					
F																																					
	1	2	3	4	5	6	7	8																													

TABELLA COLORI CAVI - TABLE ELECTRICAL CABLES (Norme EN 60204-1)		
NERO - BLACK	BK	Conduttore di Potenza Principale in AC/DC - Main Power Circuits AC and DC
AZZURRO - LIGHT BLUE	BU	Conduttore di Neutro - Neutral Conductor
ROSSO - RED	RD	Circuiti di Comando in Corrente Alternata AC 12-24-230VAC - Control Circuits in AC 12-24-230VAC
BLU SCURO - DARK BLUE	DBU	Circuiti di Comando in Corrente Continua DC 24VDC - Control Circuits in DC 24VDC
ARANCIONE - ORANGE	OG	Circuiti Segnali in Tensione - Voltage Signal Circuits
BIANCO - WHITE	WH	Circuiti di Misura - Measuring Circuits
GIALLO-VERDE	GNYE	Conduttore di Terra - Grounded Conductors

Wiring diagram ICEP022-027E (Fan speed option)

Sheet 3/15

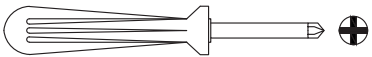
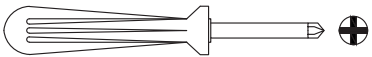
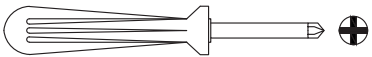
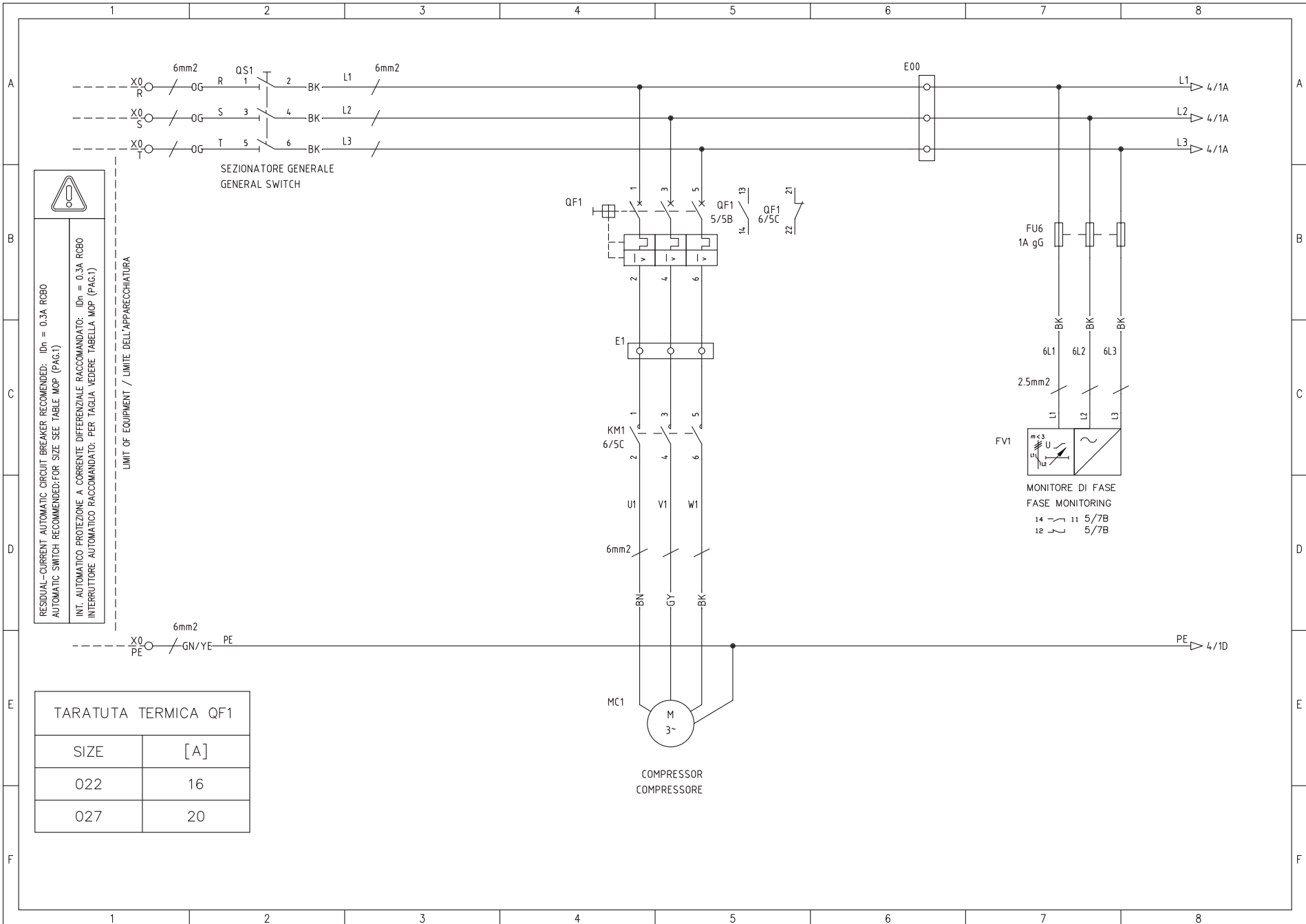

Wiring diagram ICEP022-027E (Fan speed option)

Sheet 4/15

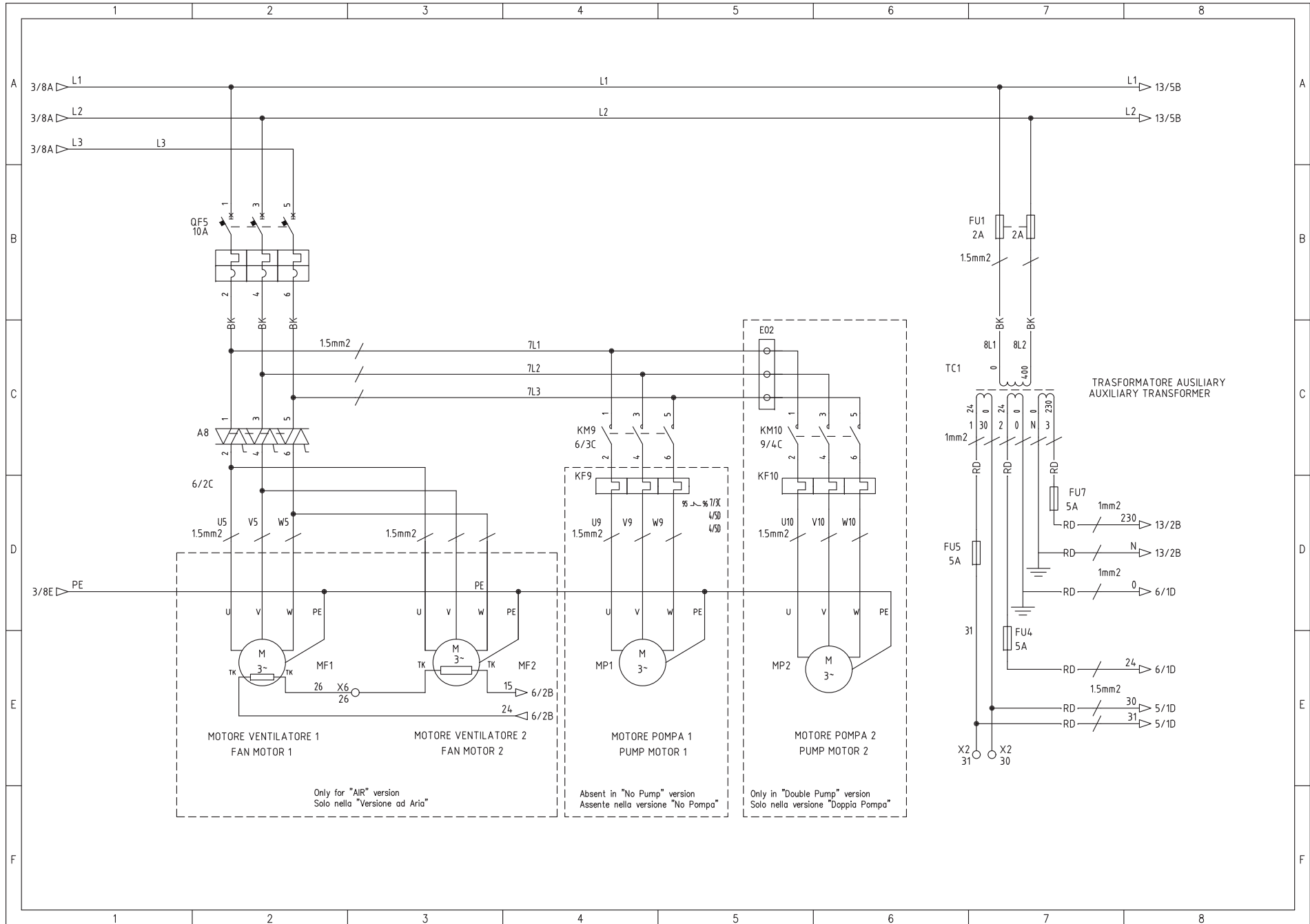

Wiring diagram ICEP022-027E (Fan speed option)

Sheet 5/15

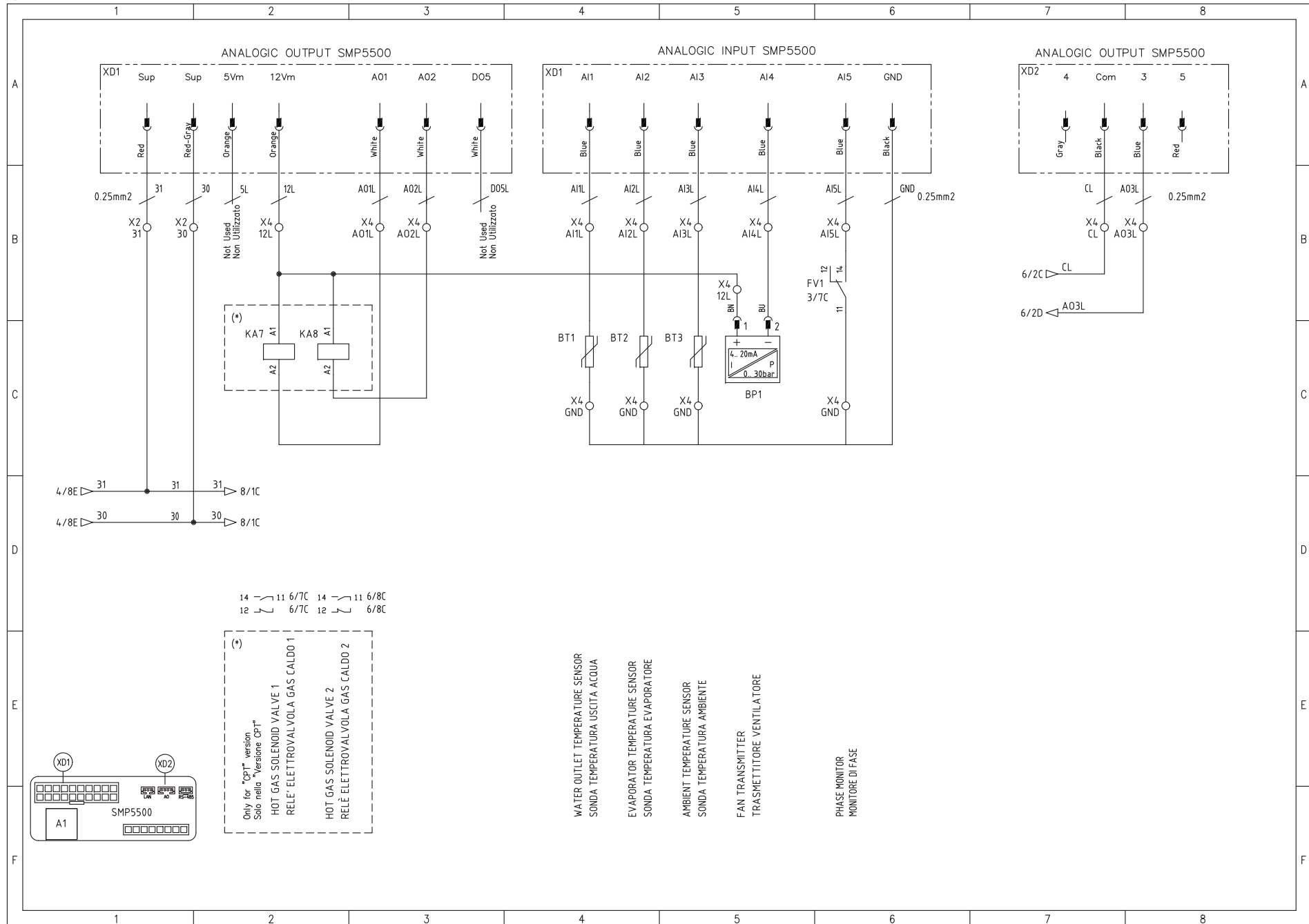

Wiring diagram ICEP022-027E (Fan speed option)

Sheet 6/15

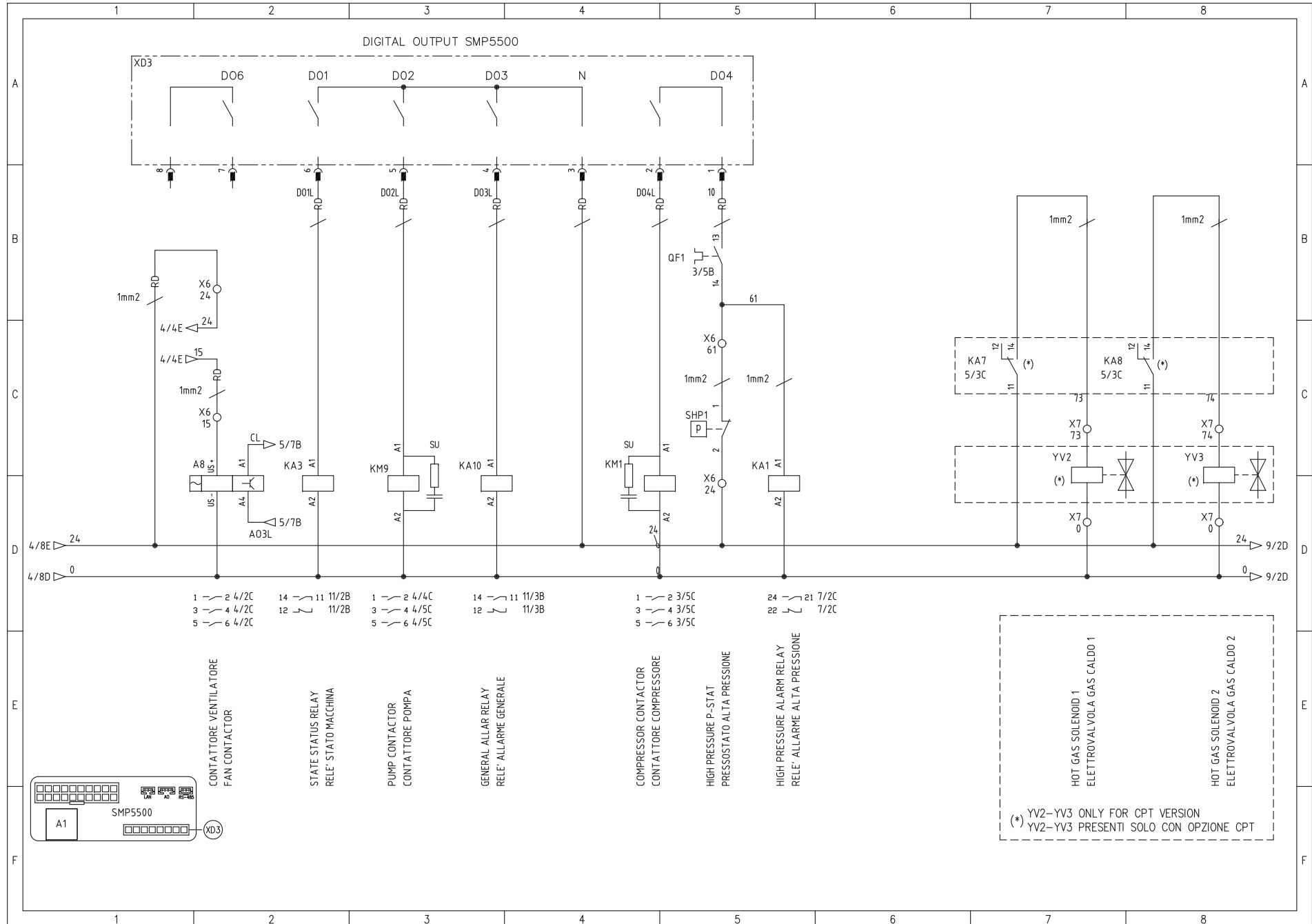

Wiring diagram ICEP022-027E (Fan speed option)

Sheet 7/15

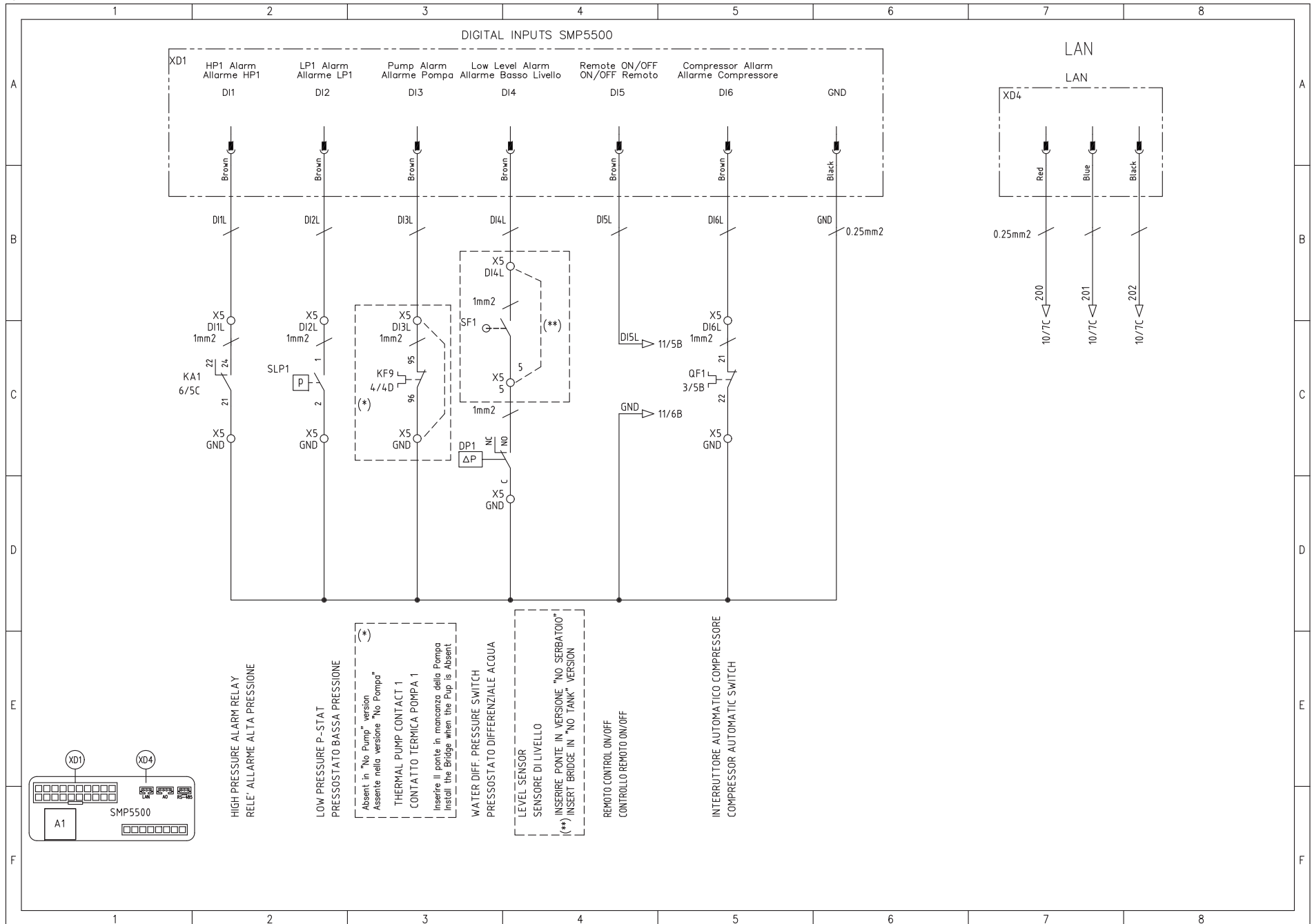

Wiring diagram ICEP022-027E (Fan speed option)

Sheet 8/15

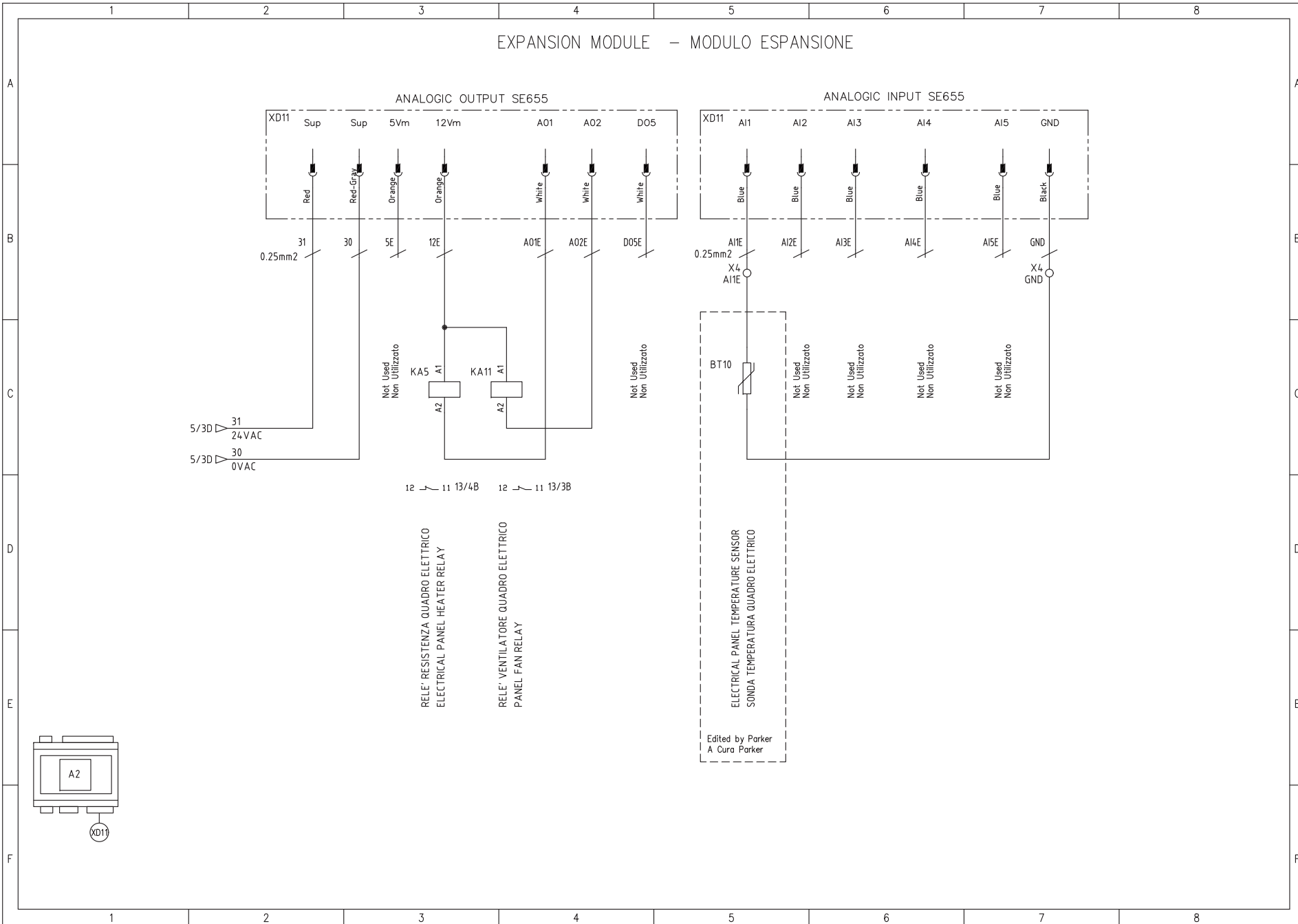

Wiring diagram ICEP022-027E (Fan speed option)

Sheet 9/15

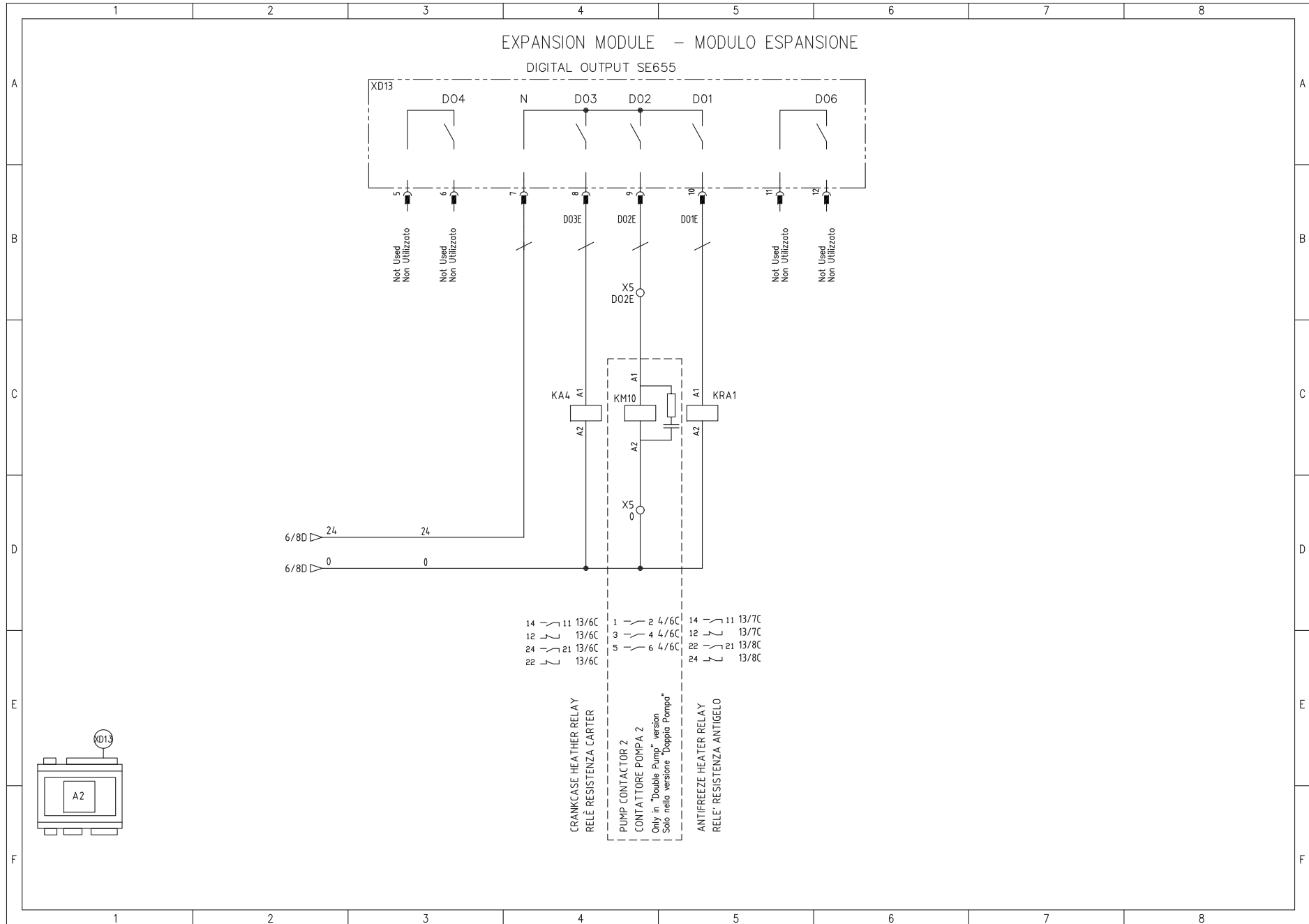

Wiring diagram ICEP022-027E (Fan speed option)

Sheet 10/15

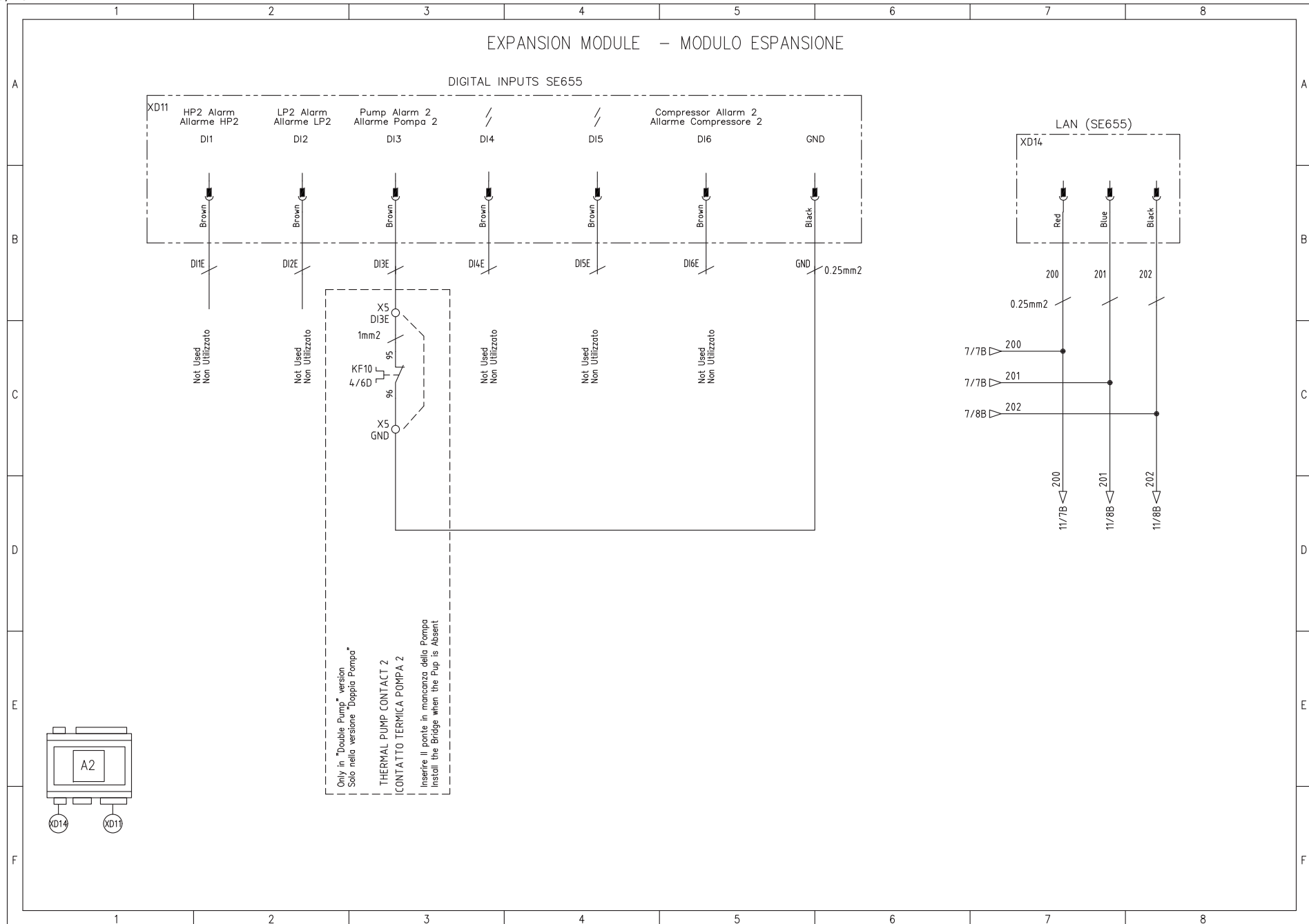

Wiring diagram ICEP022-027E (Fan speed option)

Sheet 11/15

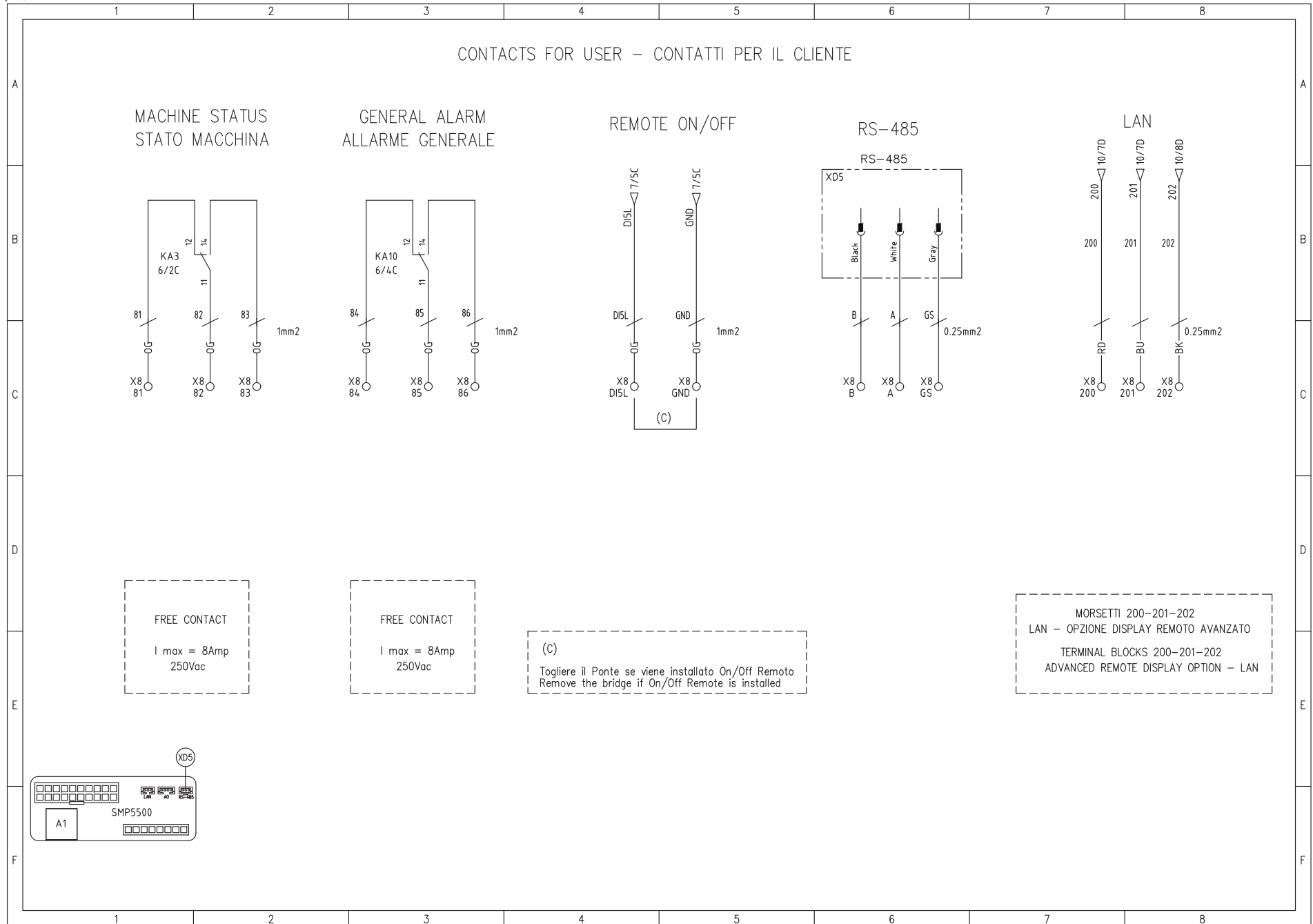

Wiring diagram ICEP022-027E (Fan speed option)

Sheet 12/15

OPTIONAL CONNECTIONS – COLLEGAMENTI OPZIONALI

Simple Remote Control – OPTION – Consult Parker
 OPZIONE – Controllo Remoto Semplice – Consultare Parker

A100

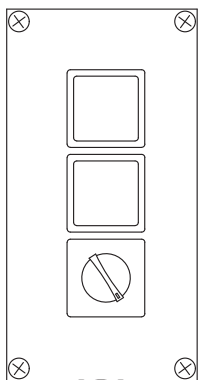

ON SIGNAL LAMP
 LAMPADA SEGNALAZIONE ON

ALARM SIGNAL LAMP
 LAMPADA SEGNALAZIONE ALLARME

INTERRUPTORE ON/OFF
 ON/OFF INTERRUPTER

ADVANCE REMOTE Control – OPTION – Consult Parker
 OPZIONE – Controllo Remoto Avanzato – Consultare Parker

A103

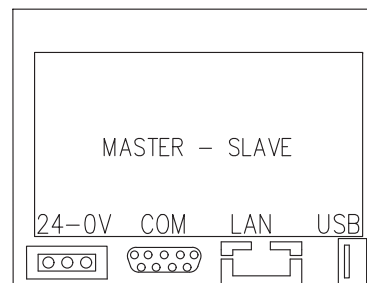

MASTER – SLAVE

MODBUS TCP-IP – OPTION – Consult Parker
 OPZIONE – MODBUS TCP-IP – Consultare Parker

A104

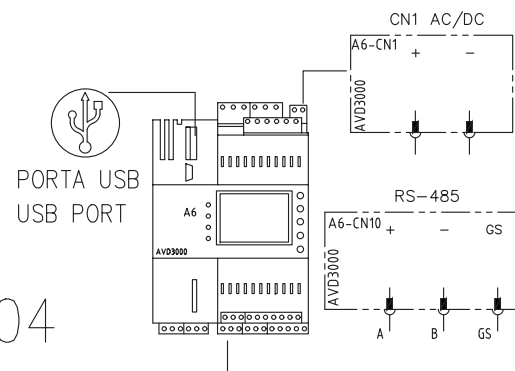

Wiring diagram ICEP022-027E (Fan speed option)

Sheet 13/15

OPTION TERMINAL BLOCKS – MORSETTI COLLEGAMENTI OPZIONI

Electrical Panel Heater/Fan
Resistenza Quadro Elettrico/Ventilazione

Crankcase Heater Compressor
Resistenza Carter compressore

Antifreeze Heater
Resistenza Antigelo

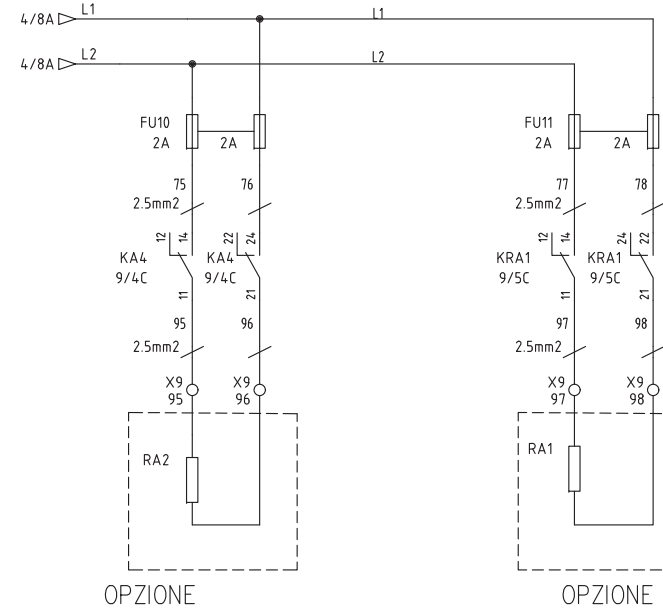
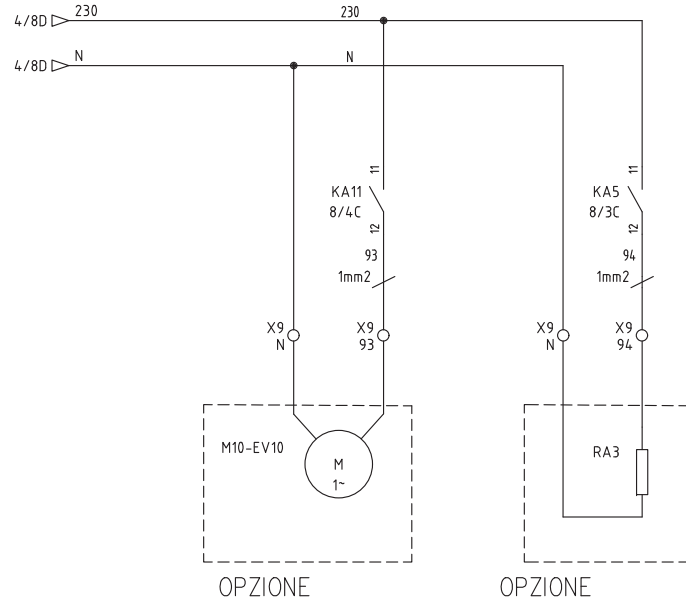

ELECTRICAL PANEL FAN MOTOR
MOTORE VENTILATORE QUADRO ELETTRICO

ELECTRICAL PANEL HEATHER
RESISTENZA QUADRO ELETTRICO

CRANKCASE HEATHER
RESISTENZA CARTER

ANTIFREEZE HEATHER
RESISTENZA ANTIFREEZE

Wiring diagram ICEP022-027E (Fan speed option)

Sheet 15/15

PLAMINETRIA QUADRO ELETTRICO – ELECTRICAL PANEL LAYOUT

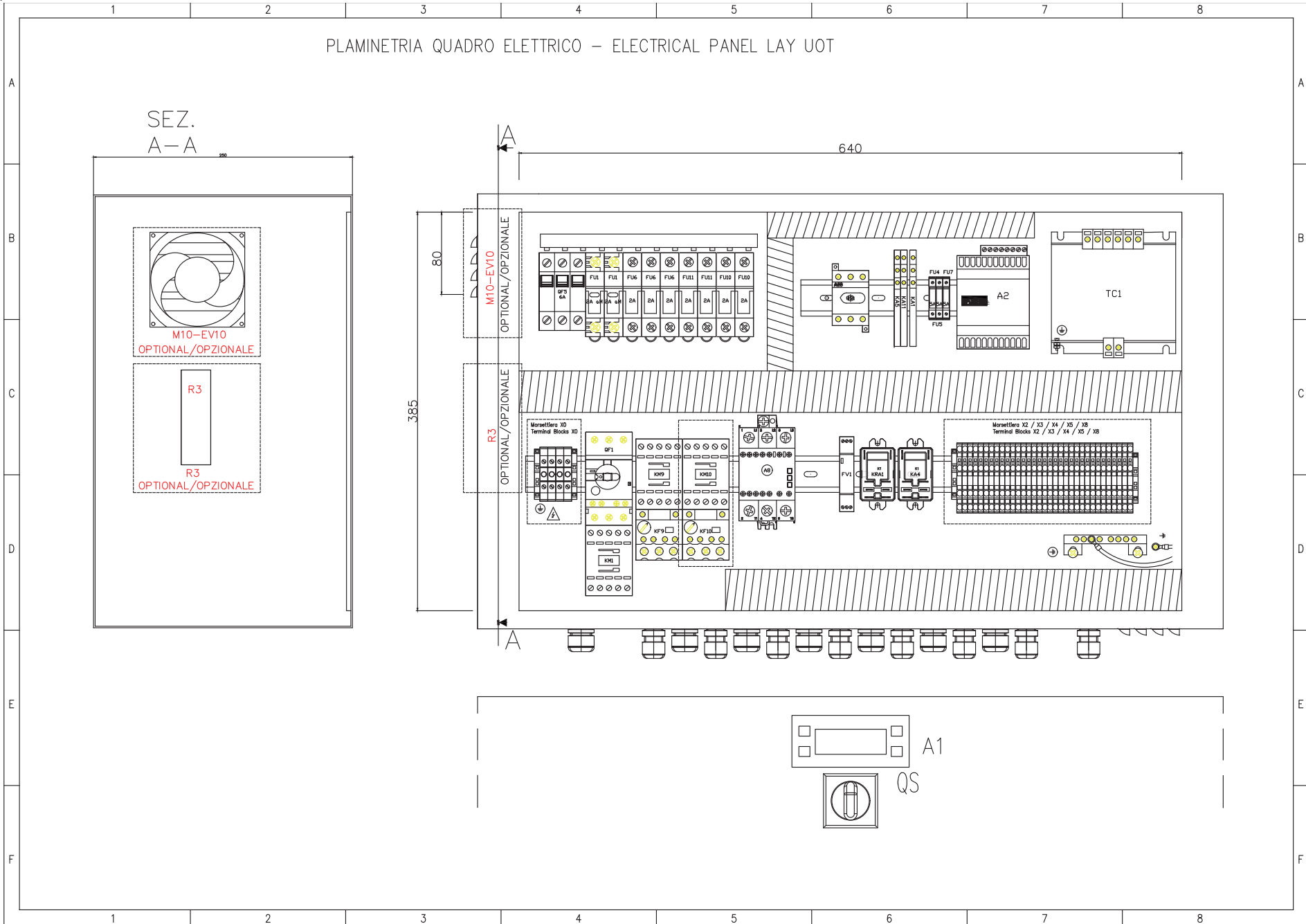



A division of Parker Hannifin Corporation

Parker Hannifin Manufacturing S.r.l.

Sede Legale: Via Sebastiano Caboto 1, Palazzina "A" 20094 Corsico (MI) Italy

Sede Operativa: **Gas Separation and Filtration Division EMEA** - Strada Zona Industriale,
35020 S. Angelo di Piove (PD) Italy

tel +39 049 971 2111- fax +39 049 9701911

Web-site: www.parker.com

ENERGOEKONOM
spol. s r.o.

ENGINEERING YOUR SUCCESS.